



Where **high performance**
is the **standard**®



Including

 **M.A. FORD**
High Performance Cutting Tools
ADVANCED PRODUCT GROUP

MICRO Tools Catalog 2020

www.maford.com



Where **high performance** is the **standard**

Since 1919 M.A. Ford® has grown from a small mid-west maker of rotary files to a leading manufacturer of Standard, High Performance and Custom Cutting tools with manufacturing and distribution facilities all over the world. Centrally located in Davenport, Iowa, with national and international distribution through an extensive network of distributors and manufacturer's representatives.



M.A. Ford® responds to customer tooling needs. Our extensive line of standard product are on the shelf for immediate shipping and technical support is just a phone call away.

For special or unique applications that require more than standard tooling, M.A. Ford's Custom Tooling Division can design a unique solution for your specific application, creating the best possible solution for your manufacturing requirements. The Custom Tool Division is part of our ongoing strategic focus on being the Best Value Tooling Partner in Innovation for Today's Industries.



ISO 9001:2015 Certified

⚠ WARNING: This product can expose you to chemicals including nickel, cobalt, and lead, which are known to the State of California to cause cancer, and chemicals including lead which are known to the State of California to cause birth defects or other reproductive harm. For more information go to www.P65Warnings.ca.gov.

MICRO Tools

M.A.Ford® is a leading manufacturer of precision ground micro carbide cutting tools. Included in our product line are micro carbide drills, carbide coolant-fed drills, carbide end mills, carbide burs, carbide reamers, HSS and carbide countersinks and carbide routers.

Our micro cutting tools are manufactured to the highest standards, so you're assured of quality and performance.

Series Number by Page

HP Drills		
Series No.	Cat. Pg.	Tech Pg.
229	14	52
2MDCL	13	50
305	15	53
MPDCS	9	46
MXDCL	12	46
MXDCR	11	46
MXDSR	10	46

GP Drills		
Series No.	Cat. Pg.	Tech Pg.
200	23	55
204	26	57
205	27	59
206	30	57
207	31	59
224	32	58
226	33	58
300	34	61
302	37	62
402	42	64
405	43	64

HP End Mills		
Series No.	Cat. Pg.	Tech Pg.
156	74	116
158	77	118
3MVR	72	113
3MVS	68	113

GP End Mills		
Series No.	Cat. Pg.	Tech Pg.
111	79	125
116	84	125
121	90	125
140	96	125
150	99	125
163	82	127
164	93	127
165	98	127
166	102	127
169	87	127



Reamers		
Series No.	Cat. Pg.	Tech Pg.
270	138	152
270L	138	152
270P	140	152
272	141	152

Countersinks		
Series No.	Cat. Pg.	Tech Pg.
60	156	158
61	156	158
61B	156	158
61T	156	158
78	157	158
79	157	158
79B	157	158
79T	157	158

Routers		
Series No.	Cat. Pg.	Tech Pg.
230	165	167
231	165	167
231B	165	167
231D	166	167
231F	166	167
239	162	163

















Safety Note

Always wear the appropriate personal protective equipment such as safety glasses and protective clothing when using solid carbide or HSS cutting tools. Machines should be fully guarded.













For carbide bur offering, see full line catalog or visit www.maford.com.















Twister XD® Drills - Page 9 - 12

Series	Tool Illustration	Coolant	Size Range	Length	Drill Point Angle	Helix Angle	Material Group	Page
MPDCS	 Micro Pilot Drill Single Margin		1.0mm - 2.95mm		141°-143°	30°		9
MXDSR	 Micro Drill Single Margin		0.50mm - 2.95mm		135°-140°	30°		10
MXDCR	 Micro Drill Single Margin		1.0mm - 2.95mm		135°-140°	30°		11
MXDCL	 Micro Drill Single Margin		1.0mm - 2.95mm		135°-140°	30°		12
Technical Information								44

Twister® HP Drills - Page 13 - 20































Series	Tool Illustration	Coolant	Size Range	Length	Drill Point Angle	Helix Angle	Material Group	Page
2MDCL	 Micro Drill Single Margin		2.0mm - 2.95mm		140°	15°		13
229	 3 Flute Drill Single Margin		3/64" - 1/8" - 2.0mm - 3.1 mm		144° ≤12mm	30°		14
305	 Micro Drill Single Margin Length varies depending on size		#102 - 1/8" - 0.1mm - 3.0mm		135°	12°		15
Technical Information								44

Twister® GP Drills - Page 23 - 43

Series	Tool Illustration	Coolant	Size Range	Length	Drill Point Angle	Helix Angle	Material Group	Page
200	 Hi-Roc®		#68 - 1/8" - 0.8mm - 3.1mm		135°	Straight Flute		23
204	 Inch Jobbers		#80 - 1/8"		118°	21°		26
205	 Inch Stub		#80 - 1/8" - 0.3mm - 3.1mm		135°	12°		27
Technical Information								44



Twister® GP Drills - Page 23 - 43 Continued

Series	Tool Illustration	Coolant	Size Range	Length	Drill Point Angle	Helix Angle	Material Group	Page
206	 Inch Stub		#60 - 1/8"	 3X	118°	21°		30
207			#42 - 1/8" 2.4mm - 3.1mm	 3X	Brad & Spur	35°		31
224	 Metric Jobbers		0.3mm - 3.00mm	 5X	118°	21°		32
226	 Metric Stub		1.0mm - 3.00mm	 3X	118°	21°		33
300	 Micro Drill Straight Shank		#80 - 1/8" 0.5mm - 3.15mm		118°	35°		34
302	 Micro Drill		#102 - 1/8" 0.1mm - 3.15mm		130°	35°		37
402	 Center Drill		#00 - #4 0.5mm - 3.15mm	-	-	-		42
405	 Center Drill		#00 - #4	-	-	-		43
Technical Information								44

TuffCut® HP End Mills - Page 68 - 78













Series	Tool Illustration	Z	Size Range	Length	Corner Type	Helix Angle	Material Group	Page
3MVS	 Center Cutting	3	1/64" - 1/8" 0.5mm - 3.0mm		Neck Relief Square End Corner Radius	31°/35° Variable		68
3MVR	 Center Cutting	3	1/64" - 1/8" 0.5mm - 3.0mm		Square End Corner Radius	31°/35° Variable		72
156	 Center Cutting	2	1/64" - 1/8" 0.5mm - 3.0mm		Neck Relief Ball Nose	20°		74
158	 Center Cutting	4	2.0mm - 3.0mm		Neck Relief Corner Radius	35°/38° Variable		77
Technical Information								104

Table of Contents











TuffCut® GP End Mills - Page 79 - 102

Series	Tool Illustration	Z	Size Range	Length	Corner Type	Helix Angle	Material Group	Page
111	 Center Cutting	4	.0050" - 1/8" 0.2mm - 3.0mm		Square End Corner Radius	30°		79
111 Coated	 Center Cutting	4	1/8" 1.0mm - 3.0mm		Square End	30°		81
163	 Center Cutting	4	.0050" - 1/8" 1.0mm - 3.0mm		Square End	30°		82
116	 Center Cutting	3	1/64" - 1/8" 1.0mm - 3.0mm		Square End Corner Radius	30°		84
116 Coated	 Center Cutting	3	1/16" - 1/8" 1.0mm - 3.0mm		Square End Corner Radius	30°		85
169	 Center Cutting	3	1/64" - 1/8" 1.0mm - 3.0mm		Square End Corner Radius	30°		87
169 Coated	 Center Cutting	3	1/16" - 1/8" 3.0mm		Square End Corner Radius	30°		88
121	 Center Cutting	2	.0050" - 1/8" 0.2mm - 3.0mm		Square End Corner Radius	30°		90
121 Coated	 Center Cutting	2	1/8" 1.0mm - 3.0mm		Square End	30°		92
164	 Center Cutting	2	.0050" - 1/8" 0.2mm - 3.0mm		Square End	30°		93
140	 Center Cutting	4	1/32" - 1/8" 1.0mm - 3.0mm		Ball Nose	30°		96
140 Coated	 Center Cutting	4	1/8" 1.0mm - 3.0mm		Ball Nose	30°		97
165	 Center Cutting	4	1/64" - 1/8" 1.0mm - 3.0mm		Ball Nose	30°		98









TuffCut® GP End Mills - Page 79 - 102 Continued

Series	Tool Illustration	Z	Size Range	Length	Corner Type	Helix Angle	Material Group	Page
150	 Center Cutting	2	.0150" - 1/8" 0.4mm - 3.0mm		Ball Nose	30°		99
150 Coated	 Center Cutting	2	1/8" 1.0mm - 3.0mm		Ball Nose	30°		101
166	 Center Cutting	2	1/64" - 1/8" 1.0mm - 3.0mm		Ball Nose	30°		102
Technical Information								104

TrueSize® Reamers - Page 138 - 148

Series	Tool Illustration	Z	Size Range	Lead Cutting Angle	Material Group	Page
270 Straight Flute		4 RHC	.0434" - .1280" 1.10mm - 3.25mm			138
270L Left Hand Spiral		4 LHS-RHC	.0434" - .1280" 1.10mm - 3.25mm			138
270P Precision Tolerance OD		4 RHC	.0434" - .1280" 1.10mm - 3.25mm			140
272		4 RHC	.0130" - 1/8" 0.35mm - 3.15mm			141
Technical Information						149

Countersinks - Page 156 - 157

Series	Tool Illustration	Z	Size Range	Material	Included Angle	Material Group	Page
60		1	1/8"	C	60° 82° 90° 100°		156
61		1	1/8"	HSS	60° 82° 90° 100° 120°		156
61B		1	1/8"	HSS	60° 82° 90° 100° 120°		156
Technical Information							158



Countersinks - Page 156 - 157 Continued

Series	Tool Illustration	Z	Size Range	Material	Included Angle	Material Group	Page
61T		1	1/8"	HSS	60° 82° 90° 100° 120°		156
78		6	1/8"	C	60° 82° 90° 100° 120°		157
79		6	1/8"	HSS	60° 82° 90° 100° 120°		157
79B		6	1/8"	HSS	60° 82° 90° 100° 120°		157
79T		6	1/8"	HSS	60° 82° 90° 100° 120°		157
Technical Information							158

Routers - Page 162 - 166

Series	Tool Illustration	End Grind	Size Range	Cut	Coating	Material Group	Page
230		Safe	1/32" - 1/8" 0.8mm - 3.0mm	Down	-		165
231		End Mill	1/32" - 1/8" 0.8mm - 3.0mm	Down	-		165
231B		Bur	1/32" - 1/8" 0.8mm - 3.0mm	Down	-		165
231D		Drill	1/32" - 1/8" 0.8mm - 3.0mm	Down	-		166
231F		Fishtail	1/32" - 1/8" 0.8mm - 3.0mm	Down	-		166
239		Bur End Mill Safe Fishtail	1/8" 3.0mm	Up	GemX		162
Technical Information							163/167



	Page
Custom Tool Division	170
Coatings	173
M.A.Ford® PCD	174
Firearm Arsenal	175
Material Conversion Chart	176

Icon Glossary

Drill Icons



Solid Carbide



Coolant Fed



3X Drill Length



135° Drill Point Angle



12° Helix Angle



Coatings



>3mm DIN 6537L
DIN Specs

Workpiece Material Group



P Steels

H Hardened Steels (35-65Rc)

M Stainless Steels

K Cast Iron

S Special Alloys

N Non-Ferrous

HP Drill Selection Chart See Page 44.

Drill Terminology See Page 66.

End Mill Icons



23 Number of Flutes



Center Cutting



Lengths



Coatings



30° Helix Angle



Ball Nose



Neck Relief



Corner Radius



Shank



HB
DIN6535
Shank/DIN



Chipbreaker

Workpiece Material Group



P Steels

H Hardened Steels (35-65Rc)

M Stainless Steels

K Cast Iron

S Special Alloys

N Non-Ferrous

End Mill Terminology See Page 124.

For product information, call your local distributor.

Need a coated tool?

Any uncoated standard catalog tool can be coated - Contact Customer Service for available options.

Twister XD[®]

Xtreme High Performance Drilling

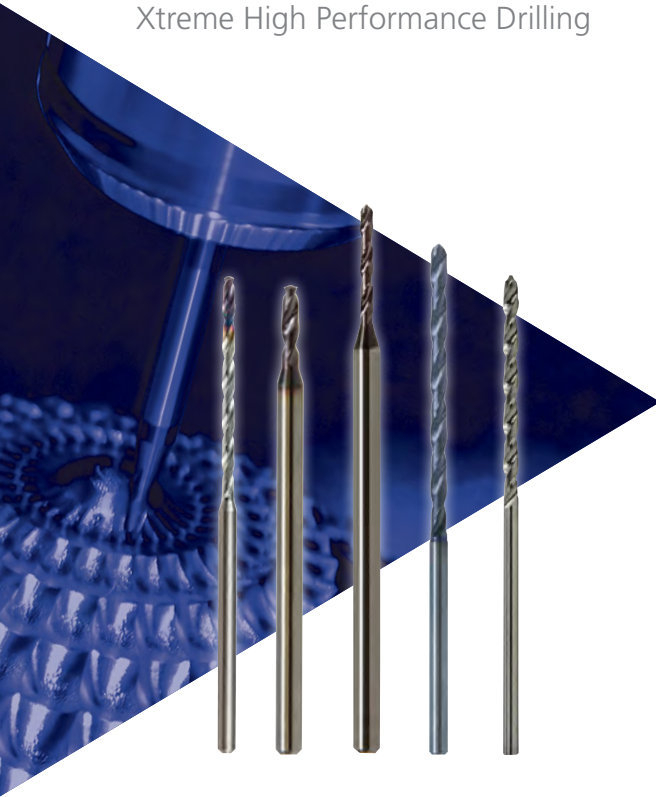

Features

- Advanced “Active Cut” Geometric Design.
- Redefined Critical Cut Zone Characteristics.
- High Efficiency Flute Profile.
- “State-of-the-Art” Proprietary Coating.
- Stable Low-Thrust Point Form.
- Coolant-Fed or Solid.
- Diameter Range - .5mm to 20.0mm, 1/64” to 3/4” See full line catalog or visit www.maford.com for complete offering.
- Micro Pilot (2X), Micro (5X), Micro (12X), Stub (3X), Regular (5X), Long (7X+) and Extra Long (12X-25X).
- Engineered and Produced in the USA.

Benefits

- Extended Tool Life.
- Elevated Metal Removal Rates (MRR).
- Lower Cost Per Hole.
- Improved Hole/Part Quality.
- Increased Tool Reliability.
- Factory Trained Network of Application & Technical Specialists.
- Factory Reconditioning Service.
- Ideal Platform for Modification or an Engineered “Special” Tool.
- Compatibility to a Wide Range of Standard Toolholder Systems.

	Page
Twister [®] Micro Pilot Drill Series MPDCS	9
Twister [®] Micro XD Series MXDSR	10
Twister [®] Micro XD Series MXDCR	11
Twister [®] Micro XD Series MXDCL	12

	Page
Twister [®] HP Series 2MDCL	13
Twister [®] HP Series 229	14
Twister [®] Micro-Tuff [®] Series 305	15
Technical Information	44-66



Series MPDCS

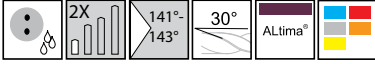

- 2 Flute.
- Pilot Drill for MXDCL Series.
- Carbide coolant fed, ALtima® coated.
- Web thinned point helps to reduce cutting forces during the drilling operation.
- All sizes have honed cutting edges on the point which increases the strength of the cutting edges.
- Post coat polishing to improve chip evacuation.

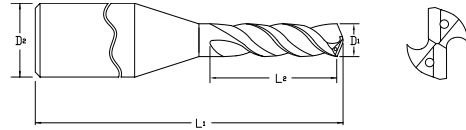

ALtima®		Diameter		Shank	OAL	Flute Length
Tool No.	EDP	D1	D2 (h6)	L1	L2	
		mm	Decimal	mm	mm	mm
MPDCSM0100A	04874	1.00	.0394	3	45	4
MPDCSM0105A	04875	1.05	.0413	3	45	4
MPDCSM0110A	04876	1.10	.0433	3	45	4
MPDCSM0115A	04877	1.15	.0453	3	45	5
MPDCSM0120A	04878	1.20	.0472	3	45	5
MPDCSM0125A	04879	1.25	.0492	3	45	5
MPDCSM0130A	04880	1.30	.0512	3	45	5
MPDCSM0135A	04881	1.35	.0531	3	45	5
MPDCSM0140A	04882	1.40	.0551	3	45	6
MPDCSM0145A	04883	1.45	.0571	3	45	6
MPDCSM0150A	04884	1.50	.0591	3	45	6
MPDCSM0155A	04885	1.55	.0610	3	45	6
MPDCSM0160A	04886	1.60	.0630	3	45	6
MPDCSM0165A	04887	1.65	.0650	3	50	7
MPDCSM0170A	04888	1.70	.0669	3	50	7
MPDCSM0175A	04889	1.75	.0689	3	50	7
MPDCSM0180A	04890	1.80	.0709	3	50	7
MPDCSM0185A	04891	1.85	.0728	3	50	7
MPDCSM0190A	04892	1.90	.0748	3	50	8
MPDCSM0195A	04893	1.95	.0768	3	50	8
MPDCSM0200A	04894	2.00	.0787	3	50	8
MPDCSM0205A	04895	2.05	.0807	3	60	8
MPDCSM0210A	04896	2.10	.0827	3	60	8
MPDCSM0215A	04897	2.15	.0846	3	60	9
MPDCSM0220A	04898	2.20	.0866	3	60	9
MPDCSM0225A	04899	2.25	.0886	3	60	9
MPDCSM0230A	04900	2.30	.0906	3	60	9

ALtima®		Diameter		Shank	OAL	Flute Length
Tool No.	EDP	D1	D2 (h6)	L1	L2	
		mm	Decimal	mm	mm	mm
MPDCSM0235A	04901	2.35	.0925	3	60	9
MPDCSM0240A	04902	2.40	.0945	3	60	10
MPDCSM0245A	04903	2.45	.0965	3	60	10
MPDCSM0250A	04904	2.50	.0984	3	60	10
MPDCSM0255A	04905	2.55	.1004	3	60	10
MPDCSM0260A	04906	2.60	.1024	3	60	10
MPDCSM0265A	04907	2.65	.1043	3	60	11
MPDCSM0270A	04908	2.70	.1063	3	60	11
MPDCSM0275A	04909	2.75	.1083	3	60	11
MPDCSM0280A	04910	2.80	.1102	3	60	11
MPDCSM0285A	04911	2.85	.1122	3	60	11
MPDCSM0290A	04912	2.90	.1142	3	60	12
MPDCSM0295A	04913	2.95	.1161	3	60	12

Metric (mm)	
D1	Tolerance
1.00 - 2.95	+0.004/+0.014

Metric (mm)	
D2	Tolerance (h6)
3.00	+0/-0.006



Series MXDSR

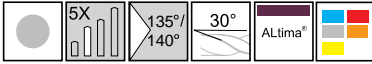

Web Thinned Point

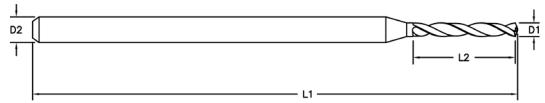

- Designed for high performance drilling in a broad range of materials.
- Web thinned point helps to reduce cutting forces during the drilling operation.
- 0.8mm diameters and above have honed cutting edges on the point which increases the strength of the cutting edges.
- All sizes have post coat polishing to improve chip evacuation.
- Coated with ALtima® Coating.

Series MXDSR

Twister XD

2 Flute

MICRO Drills

ALtima®		Diameter		Shank	OAL	Flute Length
Tool No.	EDP	D1 (h7)		D2 (h6)	L1	L2
		mm	Decimal	mm	mm	mm
MXDSRM0050A	04694	0.50	.0197	3.0	57	4.0
MXDSRM0055A	04696	0.55	.0217	3.0	57	4.0
MXDSRM0060A	04698	0.60	.0236	3.0	57	5.0
MXDSRM0065A	04700	0.65	.0256	3.0	57	5.0
MXDSRM0070A	04702	0.70	.0276	3.0	57	5.0
MXDSRM0075A	04704	0.75	.0295	3.0	57	6.0
MXDSRM0080A	04706	0.80	.0315	3.0	57	6.0
MXDSRM0085A	04708	0.85	.0335	3.0	57	7.0
MXDSRM0090A	04710	0.90	.0354	3.0	57	7.0
MXDSRM0095A	04712	0.95	.0374	3.0	57	7.0
MXDSRM0100A	04714	1.00	.0394	3.0	57	8.0
MXDSRM0105A	04716	1.05	.0413	3.0	57	8.0
MXDSRM0110A	04718	1.10	.0433	3.0	57	8.0
MXDSRM0115A	04720	1.15	.0453	3.0	57	9.0
MXDSRM0120A	04722	1.20	.0472	3.0	57	9.0
MXDSRM0125A	04724	1.25	.0492	3.0	57	9.0
MXDSRM0130A	04726	1.30	.0512	3.0	57	10.0
MXDSRM0135A	04728	1.35	.0531	3.0	57	10.0
MXDSRM0140A	04730	1.40	.0551	3.0	57	10.0
MXDSRM0145A	04732	1.45	.0571	3.0	57	11.0
MXDSRM0150A	04734	1.50	.0591	3.0	57	11.0
MXDSRM0155A	04736	1.55	.0610	3.0	57	12.0
MXDSRM0160A	04738	1.60	.0630	3.0	57	12.0
MXDSRM0165A	04740	1.65	.0650	3.0	57	12.0
MXDSRM0170A	04742	1.70	.0669	3.0	57	13.0
MXDSRM0175A	04744	1.75	.0689	3.0	57	13.0
MXDSRM0180A	04746	1.80	.0709	3.0	57	13.0

ALtima®		Diameter		Shank	OAL	Flute Length
Tool No.	EDP	D1 (h7)		D2 (h6)	L1	L2
		mm	Decimal	mm	mm	mm
MXDSRM0185A	04748	1.85	.0728	3.0	57	14.0
MXDSRM0190A	04750	1.90	.0748	3.0	57	14.0
MXDSRM0195A	04752	1.95	.0768	3.0	57	14.0
MXDSRM0200A	04754	2.00	.0787	3.0	57	15.0
MXDSRM0205A	04756	2.05	.0807	3.0	57	15.0
MXDSRM0210A	04758	2.10	.0827	3.0	57	15.0
MXDSRM0215A	04760	2.15	.0846	3.0	57	16.0
MXDSRM0220A	04762	2.20	.0866	3.0	57	16.0
MXDSRM0225A	04764	2.25	.0886	3.0	57	17.0
MXDSRM0230A	04766	2.30	.0906	3.0	57	17.0
MXDSRM0235A	04768	2.35	.0925	3.0	57	17.0
MXDSRM0240A	04770	2.40	.0945	3.0	57	18.0
MXDSRM0245A	04772	2.45	.0965	3.0	57	18.0
MXDSRM0250A	04774	2.50	.0984	3.0	57	18.0
MXDSRM0255A	04776	2.55	.1004	3.0	57	19.0
MXDSRM0260A	04778	2.60	.1024	3.0	57	19.0
MXDSRM0265A	04780	2.65	.1043	3.0	57	19.0
MXDSRM0270A	04782	2.70	.1063	3.0	57	20.0
MXDSRM0275A	04784	2.75	.1083	3.0	57	20.0
MXDSRM0280A	04786	2.80	.1102	3.0	57	20.0
MXDSRM0285A	04788	2.85	.1122	3.0	57	21.0
MXDSRM0290A	04790	2.90	.1142	3.0	57	21.0
MXDSRM0295A	04792	2.95	.1161	3.0	57	22.0

Metric (mm)	
D1	Tolerance (h7)
0 - 3.0	+0/- .010

Metric (mm)	
D2	Tolerance (h6)
0 - 3.0	+0/- .006





Series MXDCR

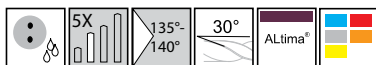

- Designed for high performance drilling in a broad range of materials.
- Web thinned point helps to reduce cutting forces during the drilling operation.
- All sizes have honed cutting edges on the point which increases the strength of the cutting edges.
- Post coat polishing to improve chip evacuation.
- Coated with ALtima® Coating.
- Carbide coolant fed.

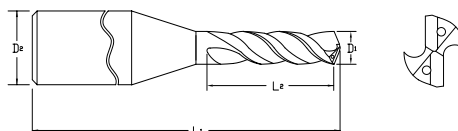

ALtima®		Diameter		Shank	OAL	Flute Length
		D1 (h7)		D2 (h6)	L1	L2
Tool No.	EDP	mm	Decimal	mm	mm	mm
MXDCRM0100A	04794	1.00	.0394	3	57	8
MXDCRM0105A	04795	1.05	.0413	3	57	8
MXDCRM0110A	04796	1.10	.0433	3	57	8
MXDCRM0115A	04797	1.15	.0453	3	57	9
MXDCRM0120A	04798	1.20	.0472	3	57	9
MXDCRM0125A	04799	1.25	.0492	3	57	9
MXDCRM0130A	04800	1.30	.0512	3	57	10
MXDCRM0135A	04801	1.35	.0531	3	57	10
MXDCRM0140A	04802	1.40	.0551	3	57	10
MXDCRM0145A	04803	1.45	.0571	3	57	11
MXDCRM0150A	04804	1.50	.0591	3	57	11
MXDCRM0155A	04805	1.55	.0610	3	57	12
MXDCRM0160A	04806	1.60	.0630	3	57	12
MXDCRM0165A	04807	1.65	.0650	3	57	12
MXDCRM0170A	04808	1.70	.0669	3	57	13
MXDCRM0175A	04809	1.75	.0689	3	57	13
MXDCRM0180A	04810	1.80	.0709	3	57	13
MXDCRM0185A	04811	1.85	.0728	3	57	14
MXDCRM0190A	04812	1.90	.0748	3	57	14
MXDCRM0195A	04813	1.95	.0768	3	57	14
MXDCRM0200A	04814	2.00	.0787	3	57	15
MXDCRM0205A	04815	2.05	.0807	3	60	15
MXDCRM0210A	04816	2.10	.0827	3	60	15
MXDCRM0215A	04817	2.15	.0846	3	60	16
MXDCRM0220A	04818	2.20	.0866	3	60	16
MXDCRM0225A	04819	2.25	.0886	3	60	17
MXDCRM0230A	04820	2.30	.0906	3	60	17

ALtima®		Diameter		Shank	OAL	Flute Length
		D1 (h7)		D2 (h6)	L1	L2
Tool No.	EDP	mm	Decimal	mm	mm	mm
MXDCRM0235A	04821	2.35	.0925	3	60	17
MXDCRM0240A	04822	2.40	.0945	3	60	18
MXDCRM0245A	04823	2.45	.0965	3	60	18
MXDCRM0250A	04824	2.50	.0984	3	60	18
MXDCRM0255A	04825	2.55	.1004	3	60	19
MXDCRM0260A	04826	2.60	.1024	3	60	19
MXDCRM0265A	04827	2.65	.1043	3	60	19
MXDCRM0270A	04828	2.70	.1063	3	60	20
MXDCRM0275A	04829	2.75	.1083	3	60	20
MXDCRM0280A	04830	2.80	.1102	3	60	20
MXDCRM0285A	04831	2.85	.1122	3	60	21
MXDCRM0290A	04832	2.90	.1142	3	60	21
MXDCRM0295A	04833	2.95	.1161	3	60	22

Metric (mm)	
D1	Tolerance (h7)
1.00 - 2.95	+0/- .010

Metric (mm)	
D2	Tolerance (h6)
3.00	+0/- .006



Series MXDCL

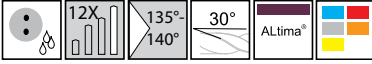

- Designed for high performance drilling in a broad range of materials.
- Web thinned point helps to reduce cutting forces during the drilling operation.
- All sizes have honed cutting edges on the point which increases the strength of the cutting edges.
- Post coat polishing to improve chip evacuation.
- Coated with ALtima® Coating.
- Carbide coolant fed.

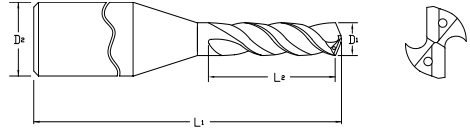

Series MXDCL

Twister® XD

2 Flute

MICRO Drills

ALtima®		Diameter		Shank	OAL	Flute Length
		D1 (h7)	D2 (h6)			
Tool No.	EDP	mm	Decimal	mm	mm	mm
MXDCLM0100A	04834	1.00	.0394	3	60	16
MXDCLM0105A	04835	1.05	.0413	3	60	17
MXDCLM0110A	04836	1.10	.0433	3	60	18
MXDCLM0115A	04837	1.15	.0453	3	60	19
MXDCLM0120A	04838	1.20	.0472	3	65	20
MXDCLM0125A	04839	1.25	.0492	3	65	20
MXDCLM0130A	04840	1.30	.0512	3	65	21
MXDCLM0135A	04841	1.35	.0531	3	65	22
MXDCLM0140A	04842	1.40	.0551	3	65	23
MXDCLM0145A	04843	1.45	.0571	3	65	24
MXDCLM0150A	04844	1.50	.0591	3	65	24
MXDCLM0155A	04845	1.55	.0610	3	65	25
MXDCLM0160A	04846	1.60	.0630	3	70	26
MXDCLM0165A	04847	1.65	.0650	3	70	27
MXDCLM0170A	04848	1.70	.0669	3	70	28
MXDCLM0175A	04849	1.75	.0689	3	70	28
MXDCLM0180A	04850	1.80	.0709	3	70	29
MXDCLM0185A	04851	1.85	.0728	3	70	30
MXDCLM0190A	04852	1.90	.0748	3	75	31
MXDCLM0195A	04853	1.95	.0768	3	75	32
MXDCLM0200A	04854	2.00	.0787	3	75	32
MXDCLM0205A	04855	2.05	.0807	3	75	33
MXDCLM0210A	04856	2.10	.0827	3	75	34
MXDCLM0215A	04857	2.15	.0846	3	75	35
MXDCLM0220A	04858	2.20	.0866	3	75	36
MXDCLM0225A	04859	2.25	.0886	3	75	36
MXDCLM0230A	04860	2.30	.0906	3	75	37

ALtima®		Diameter		Shank	OAL	Flute Length
		D1 (h7)	D2 (h6)			
Tool No.	EDP	mm	Decimal	mm	mm	mm
MXDCLM0235A	04861	2.35	.0925	3	75	38
MXDCLM0240A	04862	2.40	.0945	3	75	39
MXDCLM0245A	04863	2.45	.0965	3	75	40
MXDCLM0250A	04864	2.50	.0984	3	75	40
MXDCLM0255A	04865	2.55	.1004	3	80	41
MXDCLM0260A	04866	2.60	.1024	3	80	42
MXDCLM0265A	04867	2.65	.1043	3	80	43
MXDCLM0270A	04868	2.70	.1063	3	80	44
MXDCLM0275A	04869	2.75	.1083	3	80	44
MXDCLM0280A	04870	2.80	.1102	3	80	45
MXDCLM0285A	04871	2.85	.1122	3	80	46
MXDCLM0290A	04872	2.90	.1142	3	85	47
MXDCLM0295A	04873	2.95	.1161	3	85	48

Metric (mm)	
D1	Tolerance (h7)
1.00 - 2.95	+0/- .010

Metric (mm)	
D2	Tolerance (h6)
3.0	+0/- .006





Series 2MDCL



- Designed for high performance drilling in a broad range of materials.

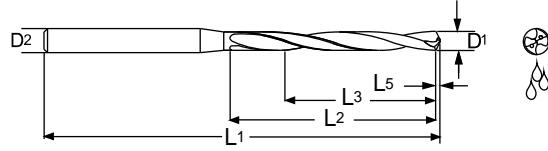

ALtima®		Diameter		Shank	OAL	Flute Length	Drill Length	Point Length
Tool No.	EDP	D1 (h8)						
		mm	Decimal	D2 (h6)	L1	L2	L3 Ref.	L5
2MDCL0787A	04198	2.00	.0787	3.0	74	24	18	0.31
2MDCL0807A	04200	2.05	.0807	3.0	74	28	21	0.32
2MDCL0827A	04202	2.10	.0827	3.0	74	28	21	0.33
2MDCL0846A	04204	2.15	.0846	3.0	74	28	21	0.33
2MDCL0866A	04206	2.20	.0866	3.0	74	28	21	0.34
2MDCL0886A	04208	2.25	.0886	3.0	74	28	21	0.35
2MDCL0906A	04210	2.30	.0906	3.0	74	28	21	0.36
2MDCL0925A	04212	2.35	.0925	3.0	74	28	21	0.36
2MDCL0945A	04214	2.40	.0945	3.0	74	28	21	0.37
2MDCL0965A	04216	2.45	.0965	3.0	74	28	21	0.38
2MDCL0984A	04218	2.50	.0984	3.0	74	28	21	0.39
2MDCL1004A	04220	2.55	.1004	3.0	81	34	25.5	0.40
2MDCL1024A	04222	2.60	.1024	3.0	81	34	25.5	0.40
2MDCL1043A	04224	2.65	.1043	3.0	81	34	25.5	0.41
2MDCL1063A	04226	2.70	.1063	3.0	81	34	25.5	0.42
2MDCL1083A	04228	2.75	.1083	3.0	81	34	25.5	0.43
2MDCL1102A	04230	2.80	.1102	3.0	81	34	25.5	0.43
2MDCL1122A	04232	2.85	.1122	3.0	81	34	25.5	0.44
2MDCL1142A	04234	2.90	.1142	3.0	81	34	25.5	0.45
2MDCL1161A	04236	2.95	.1161	3.0	81	34	25.5	0.46

Inch	
D1	Tolerance (h8)
.0787 - .1161	+0000/- .00055

Inch	
D2	Tolerance (h6)
.0787 - .1161	+0000/- .00024

Metric (mm)	
D1	Tolerance (h8)
2.00 - 2.95	+0000/- .0140

Metric (mm)	
D2	Tolerance (h6)
2.00 - 2.95	+0000/- .0060



Series 229



- Twister® AL Series 229 recommended for increased speeds and feeds when drilling aluminum and similar materials.
- Easily re-ground point design.
- Special 3 flute parabolic flute form for increased chip evacuation.
- Metric sizes 3mm and above manufactured to DIN 6537L.
- Coolant fed style available as a special.

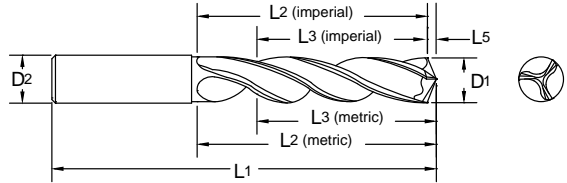

Tool No.	EDP	Diameter				Shank		OAL		Flute Length		Drill Length		Point Length		
		D1 (m7)				D2 (h6)		L1		L2		L3 Ref.		L5		
		Inch	Wire	mm	Decimal	Inch	mm	Inch	mm	Inch	mm	Inch	mm	Inch	mm	
22904690	23050	3/64	-	-	.0469	3/64	-	1 1/2	-	3/4	-	9/16	-	0.006	-	
22905500	23051	-	54	-	.0550	.0550	-	1 1/2	-	3/4	-	9/16	-	0.007	-	
22905950	23052	-	53	-	.0595	.0595	-	1 1/2	-	3/4	-	9/16	-	0.007	-	
22906250	22900	1/16	-	-	.0625	1/16	-	1 1/2	-	3/4	-	9/16	-	0.008	-	
22906700	23054	-	51	-	.0670	.0670	-	1 1/2	-	3/4	-	9/16	-	0.008	-	
22907000	23055	-	50	-	.0700	.0700	-	1 3/4	-	7/8	-	11/16	-	0.008	-	
22907300	23056	-	49	-	.0730	.0730	-	1 3/4	-	7/8	-	11/16	-	0.009	-	
22907870	22950	-	-	2.00	.0787	-	2.0	-	38	-	16.0	-	12	-	0.24	-
22908200	23057	-	45	-	.0820	.0820	-	1 3/4	-	7/8	-	11/16	-	0.010	-	
22908900	22901	-	43	-	.0890	.0890	-	2	-	1	-	3/4	-	0.011	-	
22909060	23058	-	-	2.3	.0906	-	2.3	-	43	-	20.5	-	15	-	0.28	-
22909380	22902	3/32	-	-	.0938	3/32	-	2	-	1	-	3/4	-	0.011	-	
22909600	22903	-	41	-	.0960	.0960	-	2	-	1	-	3/4	-	0.012	-	
22909800	22904	-	40	-	.0980	.0980	-	2	-	1	-	3/4	-	0.012	-	
22909840	22951	-	-	2.50	.0984	-	2.5	-	43	-	20.5	-	15	-	0.30	-
22909950	23059	-	39	-	.0995	.0995	-	2 1/4	-	1 1/4	-	15/16	-	0.012	-	
22910150	22942	-	38	-	.1015	.1015	-	2 1/4	-	1 1/4	-	15/16	-	0.012	-	
22910400	23060	-	37	-	.1040	.1040	-	2 1/4	-	1 1/4	-	15/16	-	0.013	-	
22910650	22943	-	36	-	.1065	.1065	-	2 1/4	-	1 1/4	-	15/16	-	0.013	-	
22911000	23061	-	35	-	.1100	.1100	-	2 1/4	-	1 1/4	-	15/16	-	0.013	-	
22911300	22944	-	33	-	.1130	.1130	-	2 1/4	-	1 1/4	-	15/16	-	0.014	-	
22911420	22952	-	-	2.90	.1142	-	2.9	-	46	-	25.0	-	19	-	0.35	-
22911810	22953	-	-	3.00	.1181	-	6.0	-	66	-	28.0	-	23	-	0.36	-
22912000	22905	-	31	-	.1200	.1200	-	2 1/4	-	1 1/4	-	15/16	-	0.014	-	
22912200	23063	-	-	3.10	.1220	-	6.0	-	66	-	28.0	-	23	-	0.37	-
22912500	22906	1/8	-	-	.1250	1/8	-	2 1/4	-	1 1/4	-	15/16	-	0.015	-	

See full line catalog or visit www.maford.com for complete offering.





Series 305

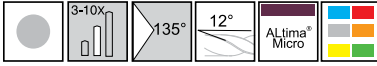

- Designed for high performance drilling in a broad range of materials.
- Depth setting rings available on 1/8" shank tools.

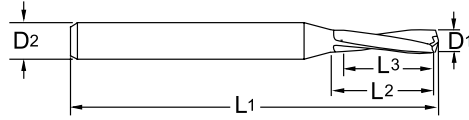

Uncoated		ALtima® Micro		Diameter				Shank		OAL		Flute Length		Drill Length	
Tool No.	EDP	Tool No.	EDP	D1				D2		L1		L2 (Max.)*		L3 Ref.	
				Inch	Letter/Wire	mm	Decimal	Inch	mm	Inch	mm	Inch	mm	Inch	mm
30500390	33999	-	-	-	102	-	0.0039	1/8	-	1-1/2	-	0.065	-	0.05	-
305M0010	34000	-	-	-	-	0.1	0.0039	-	3.0	-	38	-	1.70	-	1.28
30500430	34001	-	-	-	101	-	0.0043	1/8	--	1-1/2	-	0.065	-	0.05	--
305M0011	33900	-	-	-	-	0.11	0.0043	-	3.0	-	38	-	1.70	-	1.28
30500470	34002	-	-	-	100	-	0.0047	1/8	-	1-1/2	-	0.065	-	0.05	-
305M0012	33901	-	-	-	-	0.12	0.0047	-	3.0	-	38	-	1.70	-	1.28
30500510	34003	-	-	-	99	-	0.0051	1/8	-	1-1/2	-	0.065	-	0.05	-
305M0013	33902	-	-	-	-	0.13	0.0051	-	3.0	-	38	-	1.70	-	1.28
30500550	34004	-	-	-	98	-	0.0055	1/8	-	1-1/2	-	0.065	-	0.05	-
305M0014	33903	-	-	-	-	0.14	0.0055	-	3.0	-	38	-	1.70	-	1.28
305M0015	34005	-	-	-	-	0.15	0.0059	-	3.0	-	38	-	2.50	-	1.88
30500600	34006	-	-	-	-	-	0.0060	1/8	-	1-1/2	-	0.100	-	0.08	-
305M0016	33904	-	-	-	-	0.16	0.0063	-	3.0	-	38	--	2.50	-	1.88
30500630	34007	-	-	-	96	-	0.0063	1/8	-	1-1/2	-	0.100	-	0.08	-
305M0017	33905	-	-	-	-	0.17	0.0067	-	3.0	-	38	--	2.50	-	1.88
30500670	34008	-	-	-	95	-	0.0067	1/8	-	1-1/2	-	0.100	-	0.08	-
30500700	34009	-	-	-	-	-	0.0070	1/8	-	1-1/2	-	0.100	-	0.08	-
305M0018	33906	-	-	-	-	0.18	0.0071	-	3.0	-	38	-	2.50	-	1.88
30500710	34010	-	-	-	94	-	0.0071	1/8	-	1-1/2	-	0.100	-	0.08	-
305M0019	33907	-	-	-	-	0.19	0.0075	-	3.0	-	38	-	2.50	-	1.88
30500750	34011	-	-	-	93	-	0.0075	1/8	-	1-1/2	-	0.100	-	0.08	-
305M0020	34012	-	-	-	-	0.20	0.0078	-	3.0	-	38	-	2.50	-	1.88
30500790	34013	-	-	-	92	-	0.0079	1/8	-	1-1/2	-	0.125	-	0.09	-
30500800	34014	-	-	-	-	-	0.0080	1/8	-	1-1/2	-	0.125	-	0.09	-
305M0021	33908	-	-	-	-	0.21	0.0083	-	3.0	-	38	-	2.50	-	1.88
30500830	34015	-	-	-	91	-	0.0083	1/8	-	1-1/2	-	0.125	-	0.09	-
305M0022	33909	-	-	-	-	0.22	0.0087	-	3.0	-	38	-	2.50	-	1.88

*Do not drill beyond specified flute length. Peck cycles may be utilized to achieve best tool performance.

Inch		Inch		Metric (mm)		Metric (mm)	
D1	Tolerance	D2	Tolerance	D1	Tolerance	D2	Tolerance
.0039 - .1250	+0/-0.0003	.0039 - .1250	+0/- .0002	0.1 - 3.0	+0/-0.008	0.1 - 3.0	+0/-0.005
L1	Tolerance	L2	Tolerance	L1	Tolerance	L2	Tolerance
.0039 - .1250	+/- .015	.0039 - .1250	+0.015/-0	0.1 - 3.0	+/-0.4	0.1 - 3.0	+0.4/-0





Series 305 Continued

Uncoated		Altima® Micro		Diameter				Shank		OAL		Flute Length		Drill Length	
Tool No.	EDP	Tool No.	EDP	D1				D2		L1		L2 (Max.)*		L3 Ref.	
				Inch	Letter/ Wire	mm	Decimal	Inch	mm	Inch	mm	Inch	mm	Inch	mm
30500870	34016	-	-	-	90	-	0.0087	1/8	-	1-1/2	-	0.125	-	0.09	-
30500900	34017	-	-	-	-	-	0.0090	1/8	-	1-1/2	-	0.125	-	0.09	-
305M0023	33910	-	-	-	-	0.23	0.0091	-	3.0	-	38	-	2.50	-	1.88
30500910	34018	-	-	-	89	-	0.0091	1/8	-	1-1/2	-	0.125	-	0.09	-
305M0024	33911	-	-	-	-	0.24	0.0094	-	3.0	-	38	--	2.50	-	1.88
30500950	34019	-	-	-	88	-	0.0095	1/8	-	1-1/2	-	0.125	-	0.09	-
305M0025	34020	-	-	-	-	0.25	0.0098	-	3.0	-	38	-	3.20	-	2.40
30501000	34021	-	-	-	87	-	0.0100	1/8	-	1-1/2	-	0.150	-	0.11	-
305M0026	33912	-	-	-	-	0.26	0.0102	-	3.0	-	38	-	3.20	-	2.40
30501050	34022	-	-	-	86	-	0.0105	1/8	-	1-1/2	-	0.150	-	0.11	-
305M0027	33913	-	-	-	-	0.27	0.0106	-	3.0	-	38	-	3.20	-	2.40
30501100	34023	-	-	-	85	-	0.0110	1/8	-	1-1/2	-	0.150	-	0.11	-
305M0028	33914	-	-	-	-	0.28	0.0110	-	3.0	-	38	-	3.20	-	2.40
305M0029	33915	-	-	-	-	0.29	0.0114	-	3.0	-	38	-	3.20	-	2.40
30501150	34024	-	-	-	84	-	0.0115	1/8	-	1-1/2	-	0.150	-	0.11	-
305M0030	34025	305M0030AM	34206	-	-	0.30	0.0118	-	3.0	-	38	-	4.80	-	3.60
30501200	34026	30501200AM	34145	-	83	-	0.0120	1/8	-	1-1/2	-	0.190	-	0.14	-
305M0031	33916	-	-	-	-	0.31	0.0122	-	3.0	-	38	-	4.80	-	3.60
30501250	34027	30501250AM	34146	-	82	-	0.0125	1/8	-	1-1/2	-	0.190	-	0.14	-
305M0032	33917	-	-	-	-	0.32	0.0126	-	3.0	-	38	-	4.80	-	3.60
305M0033	33918	-	-	-	-	0.33	0.0130	-	3.0	-	38	-	4.80	-	3.60
30501300	34028	30501300AM	34147	-	81	-	0.0130	1/8	-	1-1/2	-	0.190	-	0.14	-
305M0034	33919	-	-	-	-	0.34	0.0134	-	3.0	-	38	-	4.80	-	3.60
30501350	34029	30501350AM	34148	-	80	-	0.0135	1/8	-	1-1/2	-	0.190	-	0.14	-
305M0035	34030	305M0035AM	34207	-	-	0.35	0.0138	-	3.0	-	38	-	4.80	-	3.60
305M0036	33920	-	-	-	-	0.36	0.0142	-	3.0	-	38	-	4.80	-	3.60
30501450	34031	30501450AM	34149	-	79	-	0.0145	1/8	-	1-1/2	-	0.190	-	0.14	-
305M0037	33921	-	-	-	-	0.37	0.0146	-	3.0	-	38	-	4.80	-	3.60
305M0038	33922	-	-	-	-	0.38	0.0150	-	3.0	-	38	-	4.80	-	3.60
305M0039	33923	-	-	-	-	0.39	0.0154	-	3.0	-	38	-	4.80	-	3.60
30501560	34032	30501560AM	34150	1/64	-	-	0.0156	1/8	-	1-1/2	-	0.190	-	0.14	-
305M0040	34033	305M0040AM	34208	-	-	0.40	0.0157	-	3.0	-	38	-	4.80	-	3.60
30501600	34034	30501600AM	34151	-	78	-	0.0160	1/8	-	1-1/2	-	0.190	-	0.14	-
305M0041	33924	-	-	-	-	0.41	0.0161	-	3.0	-	38	-	6.35	-	4.76
305M0042	33925	-	-	-	-	0.42	0.0165	-	3.0	-	38	-	6.35	-	4.76
305M0043	33926	-	-	-	-	0.43	0.0169	-	3.0	-	38	-	6.35	-	4.76
305M0044	33927	-	-	-	-	0.44	0.0173	-	3.0	-	38	-	6.35	-	4.76
305M0045	34035	305M0045AM	34209	-	-	0.45	0.0177	-	3.0	-	38	-	6.35	-	4.76
30501800	34036	30501800AM	34152	-	77	-	0.0180	1/8	-	1-1/2	-	0.250	-	0.19	-
305M0046	33928	-	-	-	-	0.46	0.0181	-	3	-	38	-	6.35	-	4.76
305M0047	33929	-	-	-	-	0.47	0.0185	-	3	-	38	-	6.35	-	4.76

*Do not drill beyond specified flute length. Peck cycles may be utilized to achieve best tool performance.

Series 305

Twister®
Micro-Tuff®

2
Flute

MICRO Drills



Page 53

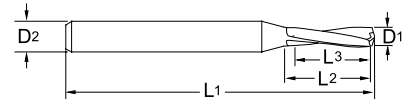

Series 305 Continued

Uncoated		ALtima® Micro		Diameter				Shank		OAL		Flute Length		Drill Length	
Tool No.	EDP	Tool No.	EDP	D1				D2		L1		L2 (Max.)*		L3 Ref.	
				Inch	Letter/ Wire	mm	Decimal	Inch	mm	Inch	mm	Inch	mm	Inch	mm
305M0048	33930	-	-	-	-	0.48	0.0189	-	3.0	-	38	-	6.35	-	4.76
305M0049	33931	-	-	-	-	0.49	0.0193	-	3.0	-	38	-	6.35	-	4.76
305M0050	34037	305M0050AM	34210	-	-	0.50	0.0197	-	3.0	-	38	-	6.35	-	4.76
30502000	34038	30502000AM	34153	-	76	-	0.0200	1/8	-	1-1/2	-	0.250	-	0.19	-
305M0051	33932	-	-	-	-	0.51	0.0201	-	3.0	-	38	-	6.35	-	4.76
305M0052	33933	-	-	-	-	0.52	0.0205	-	3.0	-	38	-	6.35	-	4.76
305M0053	33934	-	-	-	-	0.53	0.0209	-	3.0	-	38	-	6.35	-	4.76
30502100	34039	30502100AM	34154	-	75	-	0.0210	1/8	-	1-1/2	-	0.250	-	0.19	-
305M0054	33935	-	-	-	-	0.54	0.0213	-	3.0	-	38	-	6.35	-	4.76
305M0055	34040	305M0055AM	34211	-	-	0.55	0.0217	-	3.0	-	38	-	6.35	-	4.76
305M0056	33936	-	-	-	-	0.56	0.0220	-	3.0	-	38	-	6.35	-	4.76
305M0057	33937	-	-	-	-	0.57	0.0224	-	3.0	-	38	-	6.35	-	4.76
30502250	34041	30502250AM	34155	-	74	-	0.0225	1/8	-	1-1/2	-	0.250	-	0.19	-
305M0058	33938	-	-	-	-	0.58	0.0228	-	3.0	-	38	-	6.35	-	4.76
305M0059	33939	-	-	-	-	0.59	0.0232	-	3.0	-	38	-	6.35	-	4.76
305M0060	34042	305M0060AM	34212	-	-	0.60	0.0236	-	3.0	-	38	-	6.35	-	4.76
30502400	34043	30502400AM	34156	-	73	-	0.0240	1/8	-	1-1/2	-	0.250	-	0.19	-
305M0061	33940	-	-	-	-	0.61	0.0240	-	3.0	-	38	-	6.35	-	4.76
305M0062	33941	-	-	-	-	0.62	0.0244	-	3.0	-	38	-	6.35	-	4.76
305M0063	33942	-	-	-	-	0.63	0.0248	-	3.0	-	38	-	6.35	-	4.76
30502500	34044	30502500AM	34157	-	72	-	0.0250	1/8	-	1-1/2	-	0.250	-	0.19	-
305M0064	33943	-	-	-	-	0.64	0.0252	-	3.0	-	38	-	6.35	-	4.76
305M0065	34045	305M0065AM	34213	-	-	0.65	0.0256	-	3.0	-	38	-	6.35	-	4.76
305M0066	33944	-	-	-	-	0.66	0.0260	-	3.0	-	38	-	8.13	-	6.10
30502600	34046	30502600AM	34158	-	71	-	0.0260	1/8	-	1-1/2	-	0.250	-	0.19	-
305M0067	33945	-	-	-	-	0.67	0.0264	-	3.0	-	38	-	8.13	-	6.10
305M0068	33946	-	-	-	-	0.68	0.0268	-	3.0	-	38	-	8.13	-	6.10
305M0069	33947	-	-	-	-	0.69	0.0272	-	3.0	-	38	-	8.13	-	6.10
305M0070	34047	305M0070AM	34214	-	-	0.70	0.0276	-	3.0	-	38	-	8.13	-	6.10
305M0071	33948	-	-	-	-	0.71	0.0280	-	3.0	-	38	-	8.13	-	6.10
30502800	34048	30502800AM	34159	-	70	-	0.0280	1/8	-	1-1/2	-	0.320	-	0.24	-
305M0072	33949	-	-	-	-	0.72	0.0283	-	3.0	-	38	-	8.13	-	6.10
305M0073	33950	-	-	-	-	0.73	0.0287	-	3.0	-	38	-	8.13	-	6.10
305M0074	33951	-	-	-	-	0.74	0.0291	-	3.0	-	38	-	8.13	-	6.10
30502920	34049	30502920AM	34160	-	69	-	0.0292	1/8	-	1-1/2	-	0.320	-	0.24	-
305M0075	34050	305M0075AM	34215	-	-	0.75	0.0295	-	3.0	-	38	-	8.13	-	6.10
305M0076	33952	-	-	-	-	0.76	0.0299	-	3.0	-	38	-	10.16	-	7.62
305M0077	33953	-	-	-	-	0.77	0.0303	-	3.0	-	38	-	10.16	-	7.62
305M0078	33954	-	-	-	-	0.78	0.0307	-	3.0	-	38	-	10.16	-	7.62
30503100	34051	30503100AM	34161	-	68	-	0.031	1/8	-	1-1/2	-	0.4	-	0.3	-
305M0079	33955	-	-	-	-	0.79	0.0311	-	3	-	38	-	10.16	-	7.62

*Do not drill beyond specified flute length. Peck cycles may be utilized to achieve best tool performance.



Series 305 Continued

Uncoated		Altima® Micro		Diameter				Shank		OAL		Flute Length		Drill Length	
Tool No.	EDP	Tool No.	EDP	D1				D2		L1		L2 (Max.)*		L3 Ref.	
				Inch	Letter/ Wire	mm	Decimal	Inch	mm	Inch	mm	Inch	mm	Inch	mm
30503120	34052	30503120AM	34162	1/32	-	-	0.0312	1/8	-	1-1/2	-	0.400	-	0.30	-
305M0080	34053	305M0080AM	34216	-	-	0.80	0.0315	-	3.0	-	38	-	10.16	-	7.62
305M0081	33956	-	-	-	-	0.81	0.0319	-	3.0	-	38	-	10.16	-	7.62
30503200	34054	30503200AM	34163	-	67	-	0.0320	1/8	-	1-1/2	-	0.400	-	0.30	-
305M0082	33957	-	-	-	-	0.82	0.0323	-	3.0	-	38	-	10.16	-	7.62
305M0083	33958	-	-	-	-	0.83	0.0327	-	3.0	-	38	-	10.16	-	7.62
30503300	34055	30503300AM	34164	-	66	-	0.0330	1/8	-	1-1/2	-	0.400	-	0.30	-
305M0084	33959	-	-	-	-	0.84	0.0331	-	3.0	-	38	-	10.16	-	7.62
305M0085	34056	305M0085AM	34217	-	-	0.85	0.0335	-	3.0	-	38	-	10.16	-	7.62
305M0086	33960	-	-	-	-	0.86	0.0339	-	3.0	-	38	-	10.16	-	7.62
305M0087	33961	-	-	-	-	0.87	0.0343	-	3.0	-	38	-	10.16	-	7.62
305M0088	33962	-	-	-	-	0.88	0.0346	-	3.0	-	38	-	10.16	-	7.62
30503500	34057	30503500AM	34165	-	65	-	0.0350	1/8	-	1-1/2	-	0.400	-	0.30	-
305M0089	33963	-	-	-	-	0.89	0.0350	-	3.0	-	38	-	10.16	-	7.62
305M0090	34058	305M0090AM	34218	-	-	0.90	0.0354	-	3.0	-	38	-	10.16	-	7.62
305M0091	33964	-	-	-	-	0.91	0.0358	-	3.0	-	38	-	10.16	-	7.62
30503600	34059	30503600AM	34166	-	64	-	0.0360	1/8	-	1-1/2	-	0.400	-	0.30	-
305M0092	33965	-	-	-	-	0.92	0.0362	-	3.0	-	38	-	10.16	-	7.62
305M0093	33966	-	-	-	-	0.93	0.0366	-	3.0	-	38	-	10.16	-	7.62
30503700	34060	30503700AM	34167	-	63	-	0.0370	1/8	-	1-1/2	-	0.400	-	0.30	-
305M0094	33967	-	-	-	-	0.94	0.0370	-	3.0	-	38	-	10.16	-	7.62
305M0095	34061	305M0095AM	34219	-	-	0.95	0.0374	-	3.0	-	38	-	10.16	-	7.62
305M0096	33968	-	-	-	-	0.96	0.0378	-	3.0	-	38	-	10.16	-	7.62
30503800	34062	30503800AM	34168	-	62	-	0.0380	1/8	-	1-1/2	-	0.400	-	0.30	-
305M0097	33969	-	-	-	-	0.97	0.0382	-	3.0	-	38	-	10.16	-	7.62
305M0098	33970	-	-	-	-	0.98	0.0386	-	3.0	-	38	-	10.16	-	7.62
305M0099	33971	-	-	-	-	0.99	0.0390	-	3.0	-	38	-	10.16	-	7.62
30503900	34063	30503900AM	34169	-	61	-	0.0390	1/8	-	1-1/2	-	0.400	-	0.30	-
305M0100	34064	305M0100AM	34220	-	-	1.00	0.0394	-	3.0	-	38	-	10.16	-	7.62
30504000	34065	30504000AM	34170	-	60	-	0.0400	1/8	-	1-1/2	-	0.400	-	0.30	-
30504100	34066	30504100AM	34171	-	59	-	0.0410	1/8	-	1-1/2	-	0.400	-	0.30	-
305M0105	34067	305M0105AM	34221	-	-	1.05	0.0413	-	3.0	-	38	-	10.16	-	7.62
30504200	34068	30504200AM	34172	-	58	-	0.0420	1/8	-	1-1/2	-	0.400	-	0.30	-
30504300	34069	30504300AM	34173	-	57	-	0.0430	1/8	-	1-1/2	-	0.400	-	0.30	-
305M0110	34070	305M0110AM	34222	-	-	1.10	0.0433	-	3.0	-	38	-	10.16	-	7.62
305M0115	34071	305M0115AM	34223	-	-	1.15	0.0452	-	3.0	-	38	-	10.16	-	7.62
30504650	34072	30504650AM	34174	-	56	-	0.0465	1/8	-	1-1/2	-	0.400	-	0.30	-
30504690	34073	30504690AM	34175	3/64	-	-	0.0469	1/8	-	1-1/2	-	0.400	-	0.30	-
305M0120	34074	305M0120AM	34224	-	-	1.20	0.0472	-	3.0	-	38	-	10.16	-	7.62
305M0125	34075	305M0125AM	34225	-	-	1.25	0.0492	-	3	-	38	-	10.16	-	7.62
305M0130	34076	305M0130AM	34226	-	-	1.3	0.0511	-	3	-	38	-	10.16	-	7.62

*Do not drill beyond specified flute length. Peck cycles may be utilized to achieve best tool performance.

Series 305

Twister®
Micro-Tuff®

2
Flute

MICRO Drills



Page 53

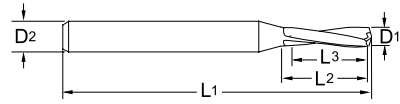

Series 305 Continued

Uncoated		Altima® Micro		Diameter				Shank		OAL		Flute Length		Drill Length	
Tool No.	EDP	Tool No.	EDP	D1				D2		L1		L2 (Max.)*		L3 Ref.	
				Inch	Letter/ Wire	mm	Decimal	Inch	mm	Inch	mm	Inch	mm	Inch	mm
30505200	34077	30505200AM	34176	-	55	-	0.0520	1/8	-	1-1/2	-	0.400	-	0.30	-
305M0135	34078	305M0135AM	34227	-	-	1.35	0.0531	-	3.0	-	38	-	10.16	-	7.62
30505500	34079	30505500AM	34177	-	54	-	0.0550	1/8	-	1-1/2	-	0.400	-	0.30	-
305M0140	34080	305M0140AM	34228	-	-	1.40	0.0551	-	3.0	-	38	-	10.16	-	7.62
305M0145	34081	305M0145AM	34229	-	-	1.45	0.0571	-	3.0	-	38	-	10.16	-	7.62
305M0150	34082	305M0150AM	34230	-	-	1.50	0.0590	-	3.0	-	38	-	10.16	-	7.62
30505950	34083	30505950AM	34178	-	53	-	0.0595	1/8	-	1-1/2	-	0.400	-	0.30	-
305M0155	34084	305M0155AM	34231	-	-	1.55	0.0610	-	3.0	-	38	-	10.16	-	7.62
30506250	34085	30506250AM	34179	1/16	-	-	0.0625	1/8	-	1-1/2	-	0.480	-	0.36	-
305M0160	34086	305M0160AM	34232	-	-	1.60	0.0630	-	3.0	-	38	-	12.19	-	9.14
30506350	34087	30506350AM	34180	-	52	-	0.0635	1/8	-	1-1/2	-	0.480	-	0.36	-
305M0165	34088	305M0165AM	34233	-	-	1.65	0.0649	-	3.0	-	38	-	12.19	-	9.14
305M0170	34089	305M0170AM	34234	-	-	1.70	0.0669	-	3.0	-	38	-	12.19	-	9.14
30506700	34090	30506700AM	34181	-	51	-	0.0670	1/8	-	1-1/2	-	0.480	-	0.36	-
305M0175	34091	305M0175AM	34235	-	-	1.75	0.0689	-	3.0	-	38	-	12.19	-	9.14
30507000	34092	30507000AM	34182	-	50	-	0.0700	1/8	-	1-1/2	-	0.480	-	0.36	-
305M0180	34093	305M0180AM	34236	-	-	1.80	0.0708	-	3.0	-	38	-	12.19	-	9.14
305M0185	34094	305M0185AM	34237	-	-	1.85	0.0728	-	3.0	-	38	-	12.19	-	9.14
30507300	34095	30507300AM	34183	-	49	-	0.0730	1/8	-	1-1/2	-	0.480	-	0.36	-
305M0190	34096	305M0190AM	34238	-	-	1.90	0.0748	-	3.0	-	38	-	12.19	-	9.14
30507600	34097	30507600AM	34184	-	48	-	0.0760	1/8	-	1-1/2	-	0.480	-	0.36	-
305M0195	34098	305M0195AM	34239	-	-	1.95	0.0767	-	3.0	-	38	-	12.19	-	9.14
30507810	34099	30507810AM	34185	5/64	-	-	0.0781	1/8	-	1-1/2	-	0.480	-	0.36	-
30507850	34100	30507850AM	34186	-	47	-	0.0785	1/8	-	1-1/2	-	0.480	-	0.36	-
305M0200	34101	305M0200AM	34240	-	-	2.00	0.0787	-	3.0	-	38	-	12.19	-	9.14
305M0205	34102	305M0205AM	34241	-	-	2.05	0.0807	-	3.0	-	38	-	12.19	-	9.14
30508100	34103	30508100AM	34187	-	46	-	0.0810	1/8	-	1-1/2	-	0.480	-	0.36	-
30508200	34104	30508200AM	34188	-	45	-	0.0820	1/8	-	1-1/2	-	0.480	-	0.36	-
305M0210	34105	305M0210AM	34242	-	-	2.10	0.0827	-	3.0	-	38	-	12.19	-	9.14
305M0215	34106	305M0215AM	34243	-	-	2.15	0.0846	-	3.0	-	38	-	12.19	-	9.14
30508600	34107	30508600AM	34189	-	44	-	0.0860	1/8	-	1-1/2	-	0.480	-	0.36	-
305M0220	34108	305M0220AM	34244	-	-	2.20	0.0866	-	3.0	-	38	-	12.19	-	9.14
305M0225	34109	305M0225AM	34245	-	-	2.25	0.0886	-	3.0	-	38	-	12.19	-	9.14
30508900	34110	30508900AM	34190	-	43	-	0.0890	1/8	-	1-1/2	-	0.480	-	0.36	-
305M0230	34111	305M0230AM	34246	-	-	2.30	0.0906	-	3.0	-	38	-	12.19	-	9.14
305M0235	34112	305M0235AM	34247	-	-	2.35	0.0925	-	3.0	-	38	-	12.19	-	9.14
30509350	34113	30509350AM	34191	-	42	-	0.0935	1/8	-	1-1/2	-	0.480	-	0.36	-
30509380	34114	30509380AM	34192	3/32	-	-	0.0938	1/8	-	1-1/2	-	0.480	-	0.36	-
305M0240	34115	305M0240AM	34248	-	-	2.40	0.0945	-	3.0	-	38	-	12.19	-	9.14
30509600	34116	30509600AM	34193	-	41	-	0.096	1/8	-	1-1/2	-	0.48	-	0.36	-
305M0245	34117	305M0245AM	34249	-	-	2.45	0.0965	-	3	-	38	-	12.19	-	9.14

*Do not drill beyond specified flute length. Peck cycles may be utilized to achieve best tool performance.



Series 305 Continued

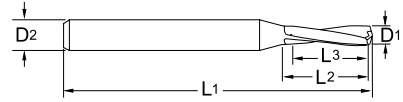

Uncoated		Altima® Micro		Diameter				Shank		OAL		Flute Length		Drill Length	
Tool No.	EDP	Tool No.	EDP	D1				D2		L1		L2 (Max.)*		L3 Ref.	
				Inch	Letter/ Wire	mm	Decimal	Inch	mm	Inch	mm	Inch	mm	Inch	mm
30509800	34118	30509800AM	34194	-	40	-	0.0980	1/8	-	1-1/2	-	0.480	-	0.36	-
305M0250	34119	305M0250AM	34250	-	-	2.50	0.0984	-	3.0	-	38	-	12.19	-	9.14
30509950	34120	30509950AM	34195	-	39	-	0.0995	1/8	-	1-1/2	-	0.480	-	0.36	-
305M0255	34121	305M0255AM	34251	-	-	2.55	0.1004	-	3.0	-	38	-	12.19	-	9.14
30510150	34122	30510150AM	34196	-	38	-	0.1015	1/8	-	1-1/2	-	0.480	-	0.36	-
305M0260	34123	305M0260AM	34252	-	-	2.60	0.1024	-	3.0	-	38	-	12.19	-	9.14
30510400	34124	30510400AM	34197	-	37	-	0.1040	1/8	-	1-1/2	-	0.480	-	0.36	-
305M0265	34125	305M0265AM	34253	-	-	2.65	0.1043	-	3.0	-	38	-	12.19	-	9.14
305M0270	34126	305M0270AM	34254	-	-	2.70	0.1063	-	3.0	-	38	-	12.19	-	9.14
30510650	34127	30510650AM	34198	-	36	-	0.1065	1/8	-	1-1/2	-	0.480	-	0.36	-
305M0275	34128	305M0275AM	34255	-	-	2.75	0.1083	-	3.0	-	38	-	12.19	-	9.14
30510940	34129	30510940AM	34199	7/64	-	-	0.1094	1/8	-	1-1/2	-	0.480	-	0.36	-
30511000	34130	30511000AM	34200	-	35	-	0.1100	1/8	-	1-1/2	-	0.480	-	0.36	-
305M0280	34131	305M0280AM	34256	-	-	2.80	0.1102	-	3.0	-	38	-	12.19	-	9.14
30511100	34132	30511100AM	34201	-	34	-	0.1110	1/8	-	1-1/2	-	0.480	-	0.36	-
305M0285	34133	305M0285AM	34257	-	-	2.85	0.1122	-	3.0	-	38	-	12.19	-	9.14
30511300	34134	30511300AM	34202	-	33	-	0.1130	1/8	-	1-1/2	-	0.480	-	0.36	-
305M0290	34135	305M0290AM	34258	-	-	2.90	0.1142	-	3.0	-	38	-	12.19	-	9.14
30511600	34136	30511600AM	34203	-	32	-	0.1160	1/8	-	1-1/2	-	0.480	-	0.36	-
305M0295	34137	305M0295AM	34259	-	-	2.95	0.1161	-	3.0	-	38	-	12.19	-	9.14
305M0300	34138	305M0300AM	34260	-	-	3.00	0.1181	-	3.0	-	38	-	12.19	-	9.14
30512000	34139	30512000AM	34204	-	31	-	0.1200	1/8	-	1-1/2	-	0.480	-	0.36	-
30512500	34143	30512500AM	34205	1/8	-	-	0.1250	1/8	-	1-1/2	-	0.480	-	0.36	-

*Do not drill beyond specified flute length. Peck cycles may be utilized to achieve best tool performance.





The "Perfect Storm" for High Performance Drilling

CXD Advanced Drilling features and benefits

New lower thrust point geometry

- Refined edge protection for better performance in titanium and stainless steel (coolant through), and carbon steels.

Enhanced double margin design

- Back margin location allows for quicker engagement in hole.
- Improved hole finishes.
- Improved location when drilling through cross holes.

ALtima® Plus AlTiN multi-layer coating

- Higher heat resistance means higher RPM capabilities.
- Optimized coating structure lengthens drill life and reduces chipping and wear.

Enhanced surface finish technology pre and post coating

- Pre-treatment enhances coating adhesion.
- Post-treatment enhances chip evacuation.

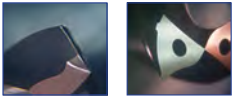

Twister XD®

Xtreme High Performance Drilling

Features

- Advanced "Active Cut" Geometric Design.
- Redefined Critical Cut Zone Characteristics.
- High Efficiency Flute Profile.
- "State-of-the-Art" Proprietary Coating.
- Stable Low-Thrust Point Form.
- Coolant-Fed or Solid.
- Diameter Range - .5mm to 20.0mm, 1/64" to 3/4".
- Micro Pilot (2X), Micro (5X), Micro (12X), Stub (3X), Regular (5X), Long (7X+) and Extra Long (12X-25X).
- Engineered and Produced in the USA.

Benefits

- Extended Tool Life.
- Elevated Metal Removal Rates (MRR).
- Lower Cost Per Hole.
- Improved Hole/Part Quality.
- Increased Tool Reliability.
- Factory Trained Network of Application & Technical Specialists.
- Factory Reconditioning Service.
- Ideal Platform for Modification or an Engineered "Special" Tool.
- Compatibility to a Wide Range of Standard Toolholder Systems.



See full line catalog or visit www.maford.com for complete offering.

Twister® GP

General Purpose Drills

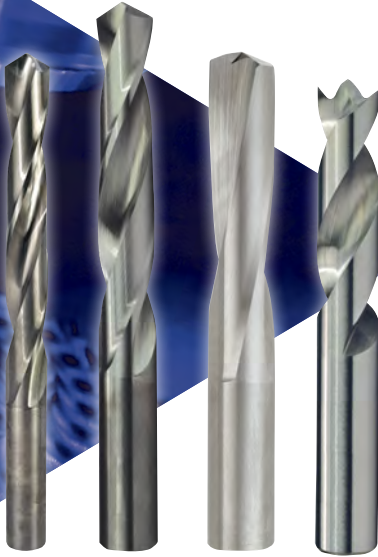

M.A.Ford® drills are designed for maximum flexibility and performance when drilling a wide variety of materials, ranging from soft, non-ferrous materials to hardened steels. Twister® GP drills are an excellent choice for all general purpose hole-making and provide these high performance benefits:

- High feed rates with excellent chip evacuation.
- Accurate hole size in a wide range of materials.
- Pre-drilling and follow-up operations can often be eliminated because of the quality and performance of M.A.Ford® drills.
- Minimal wander produces maximum precision, productivity and drill life.
- Web-thinned drill designs are available for reduced power requirements, lower temperatures and extended drill life.
- Available in a wide range of styles, sizes, lengths and coatings.
- Size ranges #102 (.0039") to 25/32" and 0.1mm to 20.0mm.
- See full line catalog or visit www.maford.com for complete offering.

	Page
Hi-Roc® Series 200	23
Twister® GP Series 204	26
Hi-Tuff® Series 205	27
Twister® GP Series 206	30
Twister® GP Series 207	31
Twister® GP Series 224	32

	Page
Twister® GP Series 226	33
Twister® GP Series 300	34
Twister® GP Series 302	37
Twister® GP Series 402	42
Twister® GP Series 405	43
Technical Information	44-66



Series 200

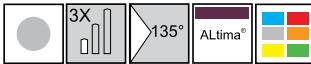

- Designed to drill hardened steel in the 42-65 Rockwell "C" range.
- Produces chips without generating excessive heat.
- Accurately sized holes are produced without annealing or softening the workpiece.
- Reamer type finishes are easily produced.
- Both a production drill and salvage or reclaim tool.
- Straight flute.

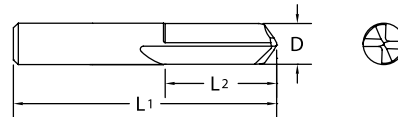

Uncoated		ALtima®		Diameter				OAL		Flute Length	
Tool No.	EDP	Tool No.	EDP	D			L1		L2		
				Inch	Letter/Wire	mm	Inch	mm	Inch	mm	
20003100	20001	-	-	-	68	-	.0310	1-1/2	-	3/16	-
20003120	20004	-	-	1/32	-	-	.0312	1-1/2	--	3/16	-
20003150	20007	-	-	-	-	0.80	.0315	-	38	-	5.0
20003200	20010	-	-	-	67	-	.0320	1-1/2	-	7/32	-
20003300	20013	-	-	-	66	-	.0330	1-1/2	-	7/32	-
20003350	20016	-	-	-	-	0.85	.0335	-	38	--	5.5
20003500	20019	-	-	-	65	-	.0350	1-1/2	-	7/32	-
20003540	20022	-	-	-	-	0.90	.0354	-	38	--	5.5
20003600	20025	-	-	-	64	-	.0360	1-1/2	-	7/32	-
20003700	20028	-	-	-	63	-	.0370	1-1/2	-	1/4	-
20003740	20031	-	-	-	-	0.95	.0374	-	38	-	6.0
20003800	20034	-	-	-	62	-	.0380	1-1/2	-	1/4	-
20003900	20037	-	-	-	61	-	.0390	1-1/2	-	1/4	-
20003940	20040	-	-	-	-	1.00	.0394	-	38	-	6.5
20004000	20043	-	-	-	60	-	.0400	1-1/2	-	1/4	-
20004100	20046	-	-	-	59	-	.0410	1-1/2	-	1/4	-
20004130	20049	-	-	-	-	1.05	.0413	-	38	-	6.5
20004200	20052	-	-	-	58	-	.0420	1-1/2	-	1/4	-
20004300	20055	-	-	-	57	-	.0430	1-1/2	-	1/4	-
20004330	20058	-	-	-	-	1.10	.0433	-	38	-	6.5
20004520	20061	-	-	-	-	1.15	.0452	-	38	-	6.5
20004650	20064	-	-	-	56	-	.0465	1-1/2	-	1/4	-
20004680	20067	-	-	3/64	-	-	.0468	1-1/2	-	1/4	-
20004720	20070	-	-	-	-	1.20	.0472	-	38	-	8.0
20004920	20073	-	-	-	-	1.25	.0492	-	38	-	8.0
20005110	20076	-	-	-	-	1.30	.0511	-	38	-	8.0

Inch	
D	Tolerance
.0310 - .1250	+ .0000/- .0005

Metric (mm)	
D	Tolerance
0.80 - 3.10	+ .000/- .013





Series 200 Continued

Series 200

Hi-Roc®

MICRO Drills

2 Flute

Uncoated		Altima®		Diameter				OAL		Flute Length	
Tool No.	EDP	Tool No.	EDP	D				L1		L2	
				Inch	Letter/Wire	mm	Decimal	Inch	mm	Inch	mm
20005200	20079	-	-	-	55	-	.0520	1-1/2	-	5/16	-
20005310	20082	-	-	-	-	1.35	.0531	-	38	-	8.0
20005500	20085	-	-	-	54	-	.0550	1-1/2	-	5/16	-
20005510	20088	-	-	-	-	1.40	.0551	-	38	-	8.0
20005710	20091	-	-	-	-	1.45	.0571	-	38	-	8.0
20005900	20094	-	-	-	-	1.50	.0590	-	38	-	8.0
20005950	20097	-	-	-	53	-	.0595	1-1/2	-	5/16	-
20006250	20100	-	-	1/16	-	-	.0625	1-1/2	-	5/16	-
20006300	20103	-	-	-	-	1.60	.0630	-	38	-	8.0
20006350	20106	-	-	-	52	-	.0635	1-1/2	-	5/16	-
20006690	20109	-	-	-	-	1.70	.0669	-	38	-	9.5
20006700	20112	-	-	-	51	-	.0670	1-1/2	-	3/8	-
20007000	20115	-	-	-	50	-	.0700	1-1/2	-	3/8	-
20007080	20118	-	-	-	-	1.80	.0708	-	38	-	9.5
20007300	20121	-	-	-	49	-	.0730	1-1/2	-	3/8	-
20007480	20124	-	-	-	-	1.90	.0748	-	38	-	9.5
20007600	20127	-	-	-	48	-	.0760	1-1/2	-	3/8	-
20007810	20130	-	-	5/64	-	-	.0781	1-1/2	-	3/8	-
20007850	20133	-	-	-	47	-	.0785	1-1/2	-	3/8	-
20007870	20136	-	-	-	-	2.00	.0787	-	38	-	9.5
20008100	20139	-	-	-	46	-	.0810	1-1/2	-	1/2	-
20008200	20142	-	-	-	45	-	.0820	1-1/2	-	1/2	-
20008270	20145	-	-	-	-	2.10	.0827	-	38	-	12.5
20008600	20148	-	-	-	44	-	.0860	1-1/2	-	1/2	-
20008660	20151	-	-	-	-	2.20	.0866	-	38	-	12.5
20008900	20154	-	-	-	43	-	.0890	1-1/2	-	1/2	-
20009060	20157	-	-	-	-	2.30	.0906	-	38	-	12.5
20009350	20160	-	-	-	42	-	.0935	1-1/2	-	1/2	-
20009370	20163	-	-	3/32	-	-	.0937	1-1/2	-	1/2	-
20009450	20166	-	-	-	-	2.40	.0945	-	38	-	12.5
20009600	20169	-	-	-	41	-	.0960	1-1/2	-	1/2	-
20009800	20172	-	-	-	40	-	.0980	1-1/2	-	1/2	-
20009840	20175	-	-	-	-	2.50	.0984	-	38	-	12.5
20009950	20178	-	-	-	39	-	.0995	1-1/2	-	1/2	-
20010150	20184	-	-	-	38	-	.1015	1-1/2	-	1/2	-
20010240	20187	-	-	-	-	2.60	.1024	-	38	-	16.0
20010400	20190	-	-	-	37	-	.1040	1-1/2	-	5/8	-
20010630	20193	-	-	-	-	2.70	.1063	-	38	-	16.0
20010650	20196	-	-	-	36	-	.1065	1-1/2	-	5/8	-
20010930	20199	-	-	7/64	-	-	.1093	1-1/2	-	5/8	-
20011000	20202	-	-	-	35	-	.1100	1-1/2	-	5/8	-





Series 200 Continued

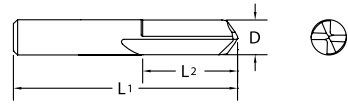

Uncoated		Altima®		Diameter				OAL		Flute Length	
Tool No.	EDP	Tool No.	EDP	D				L1		L2	
				Inch	Letter/ Wire	mm	Decimal	Inch	mm	Inch	mm
20011020	20205	-	-	-	-	2.80	.1102	-	38	-	16.0
20011100	20208	-	-	-	34	-	.1110	1-1/2	-	5/8	-
20011300	20211	-	-	-	33	-	.1130	1-1/2	-	5/8	-
20011420	20214	-	-	-	-	2.90	.1142	-	38	-	16.0
20011600	20217	-	-	-	32	-	.1160	1-1/2	-	5/8	-
20011810	20220	20011810A	96400	-	-	3.00	.1181	-	38	-	16.0
20012000	20223	-	-	-	31	-	.1200	1-1/2	-	5/8	-
20012200	20226	20012200A	96401	-	-	3.10	.1220	-	38	-	16.0
20012500	20229	-	-	1/8	-	-	.1250	1-1/2	-	5/8	-

See full line catalog or visit www.maford.com for complete offering.



Series 204

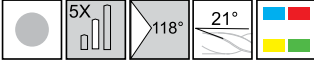

- Designed to allow high feed rates with good chip flow.
- Four facet drill point minimizes drill wander and assures accurately sized holes.
- See full line catalog or visit www.maford.com for complete offering.

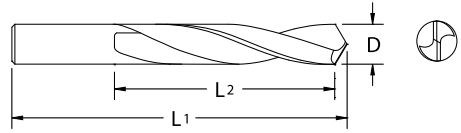

Series 204

Twister® GP

MICRO Drills

2 Flute

Tool No.	EDP	Diameter			OAL L1	Flute Length L2
		D				
		Inch	mm	Decimal		
20401350	24004	-	80	.0135	1-1/2	1/4
20401450	24010	-	79	.0145	1-1/2	1/4
20401560	24013	1/64	-	.0156	1-1/2	1/4
20401600	24019	-	78	.0160	1-1/2	1/4
20401800	24025	-	77	.0180	1-1/2	1/4
20402000	24031	-	76	.0200	1-1/2	1/4
20402100	24034	-	75	.0210	1-1/2	1/4
20402250	24040	-	74	.0225	1-1/2	1/4
20402400	24046	-	73	.0240	1-1/2	1/4
20402500	24049	-	72	.0250	1-1/2	5/16
20402600	24055	-	71	.0260	1-1/2	5/16
20402800	24061	-	70	.0280	1-1/2	5/16
20402920	24064	-	69	.0292	1-1/2	5/16
20403100	24070	-	68	.0310	1-1/2	3/8
20403120	24073	1/32	-	.0312	1-1/2	3/8
20403200	24079	-	67	.0320	1-1/2	3/8
20403300	24082	-	66	.0330	1-1/2	3/8
20403500	24088	-	65	.0350	1-1/2	3/8
20403600	24094	-	64	.0360	1-1/2	1/2
20403700	24097	-	63	.0370	1-1/2	1/2
20403800	24103	-	62	.0380	1-1/2	1/2
20403900	24106	-	61	.0390	1-1/2	1/2
20404000	24112	-	60	.0400	1-1/2	3/4
20404100	24115	-	59	.0410	1-1/2	3/4
20404200	24121	-	58	.0420	1-1/2	3/4
20404300	24124	-	57	.0430	1-1/2	3/4
20404650	24133	-	56	.0465	1-1/2	3/4
20404690	24136	3/64	-	.0469	1-1/2	3/4
20405200	24148	-	55	.0520	1-1/2	3/4
20405500	24154	-	54	.0550	1-1/2	3/4

Tool No.	EDP	Diameter			OAL L1	Flute Length L2
		D				
		Inch	mm	Decimal		
20405950	24166	-	53	.0595	1-1/2	3/4
20406250	24169	1/16	-	.0625	1-1/2	3/4
20406350	24175	-	52	.0635	1-1/2	3/4
20406700	24181	-	51	.0670	1-1/2	3/4
20407000	24184	-	50	.0700	1-3/4	7/8
20407300	24190	-	49	.0730	1-3/4	7/8
20407600	24196	-	48	.0760	1-3/4	7/8
20407810	24199	5/64	-	.0781	1-3/4	7/8
20407850	24202	-	47	.0785	1-3/4	7/8
20408100	24208	-	46	.0810	1-3/4	7/8
20408200	24211	-	45	.0820	1-3/4	7/8
20408600	24217	-	44	.0860	2	1
20408900	24223	-	43	.0890	2	1
20409350	24229	-	42	.0935	2	1
20409380	24232	3/32	-	.0938	2	1
20409600	24238	-	41	.0960	2	1
20409800	24241	-	40	.0980	2	1
20409950	24247	-	39	.0995	2-1/4	1-1/4
20410150	24250	-	38	.1015	2-1/4	1-1/4
20410400	24256	-	37	.1040	2-1/4	1-1/4
20410650	24262	-	36	.1065	2-1/4	1-1/4
20410940	24265	7/64	-	.1094	2-1/4	1-1/4
20411000	24268	-	35	.1100	2-1/4	1-1/4
20411100	24274	-	34	.1110	2-1/4	1-1/4
20411300	24277	-	33	.1130	2-1/4	1-1/4
20411600	24283	-	32	.1160	2-1/4	1-1/4
20412000	24289	-	31	.1200	2-1/4	1-1/4
20412500	24295	1/8	-	.1250	2-1/4	1-1/4

Inch	
D	Tolerance
.0135 - .1250	+0.0000/-0.0005





Series 205

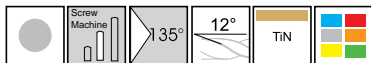

- Slow spiral.
- ALtima® coating upon request.

- Designed for drilling stainless steel, tool steels, titanium, nickel based alloys and other high strength ferrous metals.
- Screw machine lengths and a heavy web provide extra rigidity and strength.
- Web-thinned drill point reduces power requirements, lowers drilling temperatures and extends tool life.

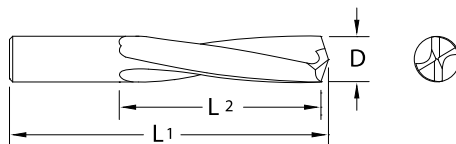

Uncoated		TiN		Diameter				OAL		Flute Length	
Tool No.	EDP	Tool No.	EDP	D				L1		L2	
				Inch	Wire	mm	Decimal	Inch	mm	Inch	mm
20501180	25001	-	-	-	-	0.30	.0118	-	38	-	5.0
20501350	25004	-	-	-	80	-	.0135	1-1/2	-	3/16	-
20501380	25007	-	-	-	-	0.35	.0138	-	38	-	5.0
20501450	25010	-	-	-	79	-	.0145	1-1/2	-	3/16	-
20501560	25013	-	-	1/64	-	-	.0156	1-1/2	-	3/16	-
20501570	25016	-	-	-	-	0.40	.0157	-	38	-	5.0
20501600	25019	-	-	-	78	-	.0160	1-1/2	-	3/16	-
20501770	25022	-	-	-	-	0.45	.0177	-	38	-	5.0
20501800	25025	-	-	-	77	-	.0180	1-1/2	-	3/16	-
20501970	25028	-	-	-	-	0.50	.0197	-	38	-	6.5
20502000	25031	-	-	-	76	-	.0200	1-1/2	-	1/4	-
20502100	25034	-	-	-	75	-	.0210	1-1/2	-	1/4	-
20502170	25037	-	-	-	-	0.55	.0217	-	38	-	6.5
20502250	25040	-	-	-	74	-	.0225	1-1/2	-	1/4	-
20502360	25043	-	-	-	-	0.60	.0236	-	38	-	6.5
20502400	25046	-	-	-	73	-	.0240	1-1/2	-	1/4	-
20502500	25049	-	-	-	72	-	.0250	1-1/2	-	5/16	-
20502560	25052	-	-	-	-	0.65	.0256	-	38	-	8.0
20502600	25055	-	-	-	71	-	.0260	1-1/2	-	5/16	-
20502760	25058	-	-	-	-	0.70	.0276	-	38	-	8.0
20502800	25061	-	-	-	70	-	.0280	1-1/2	-	5/16	-
20502920	25064	-	-	-	69	-	.0292	1-1/2	-	5/16	-
20502950	25067	-	-	-	-	0.75	.0295	-	38	-	8.0
20503100	25070	-	-	-	68	-	.0310	1-1/2	-	3/8	--
20503120	25073	20503120T	25074	1/32	-	-	.0312	1-1/2	-	3/8	-
20503150	25076	-	-	-	-	0.80	.0315	-	38	-	9.5
20503200	25079	-	-	-	67	-	.0320	1-1/2	-	3/8	-

Inch	
D	Tolerance
.0310 - .1250	+ .0000/- .0005

Metric (mm)	
D	Tolerance
0.30 - 3.10	+ .000/- .013





Series 205 Continued

Series 205

Hi-Tuff®

2 Flute

MICRO Drills

Uncoated		TiN		Diameter				OAL		Flute Length	
Tool No.	EDP	Tool No.	EDP	D				L1		L2	
				Inch	Wire	mm	Decimal	Inch	mm	Inch	mm
20503300	25082	-	-	-	66	-	.0330	1-1/2	-	3/8	-
20503350	25085	-	-	-	-	0.85	.0335	-	38	-	9.5
20503500	25088	-	-	-	65	-	.0350	1-1/2	-	7/16	-
20503540	25091	-	-	-	-	0.90	.0354	-	38	-	11.0
20503600	25094	-	-	-	64	-	.0360	1-1/2	-	7/16	-
20503700	25097	-	-	-	63	-	.0370	1-1/2	-	7/16	-
20503740	25100	-	-	-	-	0.95	.0374	-	38	-	11.0
20503800	25103	-	-	-	62	-	.0380	1-1/2	-	7/16	-
20503900	25106	-	-	-	61	-	.0390	1-1/2	-	7/16	-
20503940	25109	20503940T	25110	-	-	1.00	.0394	-	38	-	12.5
20504000	25112	-	-	-	60	-	.0400	1-1/2	-	1/2	-
20504100	25115	-	-	-	59	-	.0410	1-1/2	-	1/2	-
20504130	25118	-	-	-	-	1.05	.0413	-	38	-	12.5
20504200	25121	-	-	-	58	-	.0420	1-1/2	-	1/2	-
20504300	25124	-	-	-	57	-	.0430	1-1/2	-	1/2	-
20504330	25127	-	-	-	-	1.10	.0433	-	38	-	12.5
20504520	25130	-	-	-	-	1.15	.0452	-	38	-	12.5
20504650	25133	-	-	-	56	-	.0465	1-1/2	-	1/2	-
20504690	25136	20504690T	25137	3/64	-	-	.0469	1-1/2	-	1/2	-
20504720	25139	-	-	-	-	1.20	.0472	-	38	-	12.5
20504920	25142	-	-	-	-	1.25	.0492	-	41	-	16.0
20505110	25145	-	-	-	-	1.30	.0511	-	41	-	16.0
20505200	25148	-	-	-	55	-	.0520	1-5/8	-	5/8	-
20505310	25151	-	-	-	-	1.35	.0531	-	41	-	16.0
20505500	25154	-	-	-	54	-	.0550	1-5/8	-	5/8	-
20505510	25157	-	-	-	-	1.40	.0551	-	41	-	16.0
20505710	25160	-	-	-	-	1.45	.0571	-	41	-	16.0
20505900	25163	20505900T	25164	-	-	1.50	.0590	-	41	-	16.0
20505950	25166	-	-	-	53	-	.0595	1-5/8	-	5/8	-
20506250	25169	20506250T	25170	1/16	-	-	.0625	1-5/8	-	5/8	-
20506300	25172	-	-	-	-	1.60	.0630	-	41	-	16.0
20506350	25175	-	-	-	52	-	.0635	1-11/16	-	11/16	-
20506690	25178	-	-	-	-	1.70	.0669	-	43	-	17.5
20506700	25181	-	-	-	51	-	.0670	1-11/16	-	11/16	-
20507000	25184	20507000T	20507	-	50	-	.0700	1-11/16	-	11/16	-
20507080	25187	-	-	-	-	1.80	.0708	-	43	-	17.5
20507300	25190	-	-	-	49	-	.0730	1-11/16	-	11/16	-
20507480	25193	-	-	-	-	1.90	.0748	-	43	-	17.5
20507600	25196	-	-	-	48	-	.0760	1-11/16	-	11/16	-
20507810	25199	20507810T	25200	5/64	-	-	.0781	1-11/16	-	11/16	-
20507850	25202	-	-	-	47	-	.0785	1-3/4	-	3/4	-
20507870	25205	20507870T	25206	-	-	2.00	.0787	-	44	-	19.0





Series 205 Continued

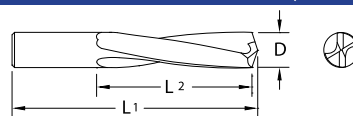

Uncoated		TiN		Diameter				OAL		Flute Length	
Tool No.	EDP	Tool No.	EDP	D				L1		L2	
				Inch	Wire	mm	Decimal	Inch	mm	Inch	mm
20508100	25208	-	-	-	46	-	.0810	1-3/4	-	3/4	-
20508200	25211	-	-	-	45	-	.0820	1-3/4	-	3/4	-
20508270	25214	-	-	-	-	2.10	.0827	-	44	-	19.0
20508600	25217	-	-	-	44	-	.0860	1-3/4	-	3/4	-
20508660	25220	-	-	-	-	2.20	.0866	-	44	-	19.0
20508900	25223	20508900T	25224	-	43	-	.0890	1-3/4	-	3/4	-
20509060	25226	-	-	-	-	2.30	.0906	-	44	-	19.0
20509350	25229	-	-	-	42	-	.0935	1-3/4	-	3/4	-
20509380	25232	20509380T	25233	3/32	-	-	.0938	1-3/4	-	3/4	-
20509450	25235	-	-	-	-	2.40	.0945	-	44	-	19.0
20509600	25238	-	-	-	41	-	.0960	1-13/16	-	13/16	-
20509800	25241	-	-	-	40	-	.0980	1-13/16	-	13/16	-
20509840	25244	20509840T	25245	-	-	2.50	.0984	-	46	-	20.5
20509950	25247	-	-	-	39	-	.0995	1-13/16	-	13/16	-
20510150	25250	-	-	-	38	-	.1015	1-13/16	-	13/16	-
20510240	25253	-	-	-	-	2.60	.1024	-	46	-	20.5
20510400	25256	-	-	-	37	-	.1040	1-13/16	-	13/16	-
20510630	25259	-	-	-	-	2.70	.1063	-	46	-	20.5
20510650	25262	-	-	-	36	-	.1065	1-13/16	-	13/16	-
20510940	25265	20510940T	25266	7/64	-	-	.1094	1-13/16	-	13/16	-
20511000	25268	-	-	-	35	-	.1100	1-7/8	-	7/8	-
20511020	25271	-	-	-	-	2.80	.1102	-	48	-	22.0
20511100	25274	-	-	-	34	-	.1110	1-7/8	-	7/8	-
20511300	25277	-	-	-	33	-	.1130	1-7/8	-	7/8	-
20511420	25280	-	-	-	-	2.90	.1142	-	48	-	22.0
20511600	25283	-	-	-	32	-	.1160	1-7/8	-	7/8	-
20511810	25286	20511810T	25287	-	-	3.00	.1181	-	48	-	22.0
20512000	25289	-	-	-	31	-	.1200	1-7/8	-	7/8	-
20512200	25292	-	-	-	-	3.10	.1220	-	48	-	22.0
20512500	25295	20512500T	25296	1/8	-	-	.1250	1-7/8	-	7/8	-

See full line catalog or visit www.maford.com for complete offering.



Series 206

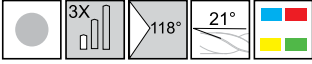

- Designed to allow high feed rates with good chip flow.
- Four facet drill point minimizes drill wander and assures accurately sized holes.
- Shorter length reduces deflection and vibration, increases drill accuracy and improves tool life.

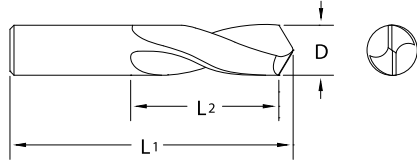

Series 206

Twister® GP

2 Flute

MICRO Drills

Tool No.	EDP	Diameter			OAL	Flute Length
		D				
		Inch	Wire	Decimal	L1	L2
20604000	26004	-	60	.0400	1-1/2	3/8
20604100	26007	-	59	.0410	1-1/2	3/8
20604200	26013	-	58	.0420	1-1/2	3/8
20604300	26016	-	57	.0430	1-1/2	3/8
20604650	26025	-	56	.0465	1-1/2	3/8
20604690	26028	3/64	-	.0469	1-1/2	3/8
20605200	26040	-	55	.0520	1-1/2	3/8
20605500	26046	-	54	.0550	1-1/2	3/8
20605950	26058	-	53	.0595	1-1/2	3/8
20606250	26061	1/16	-	.0625	1-1/2	3/8
20606350	26067	-	52	.0635	1-1/2	3/8
20606700	26073	-	51	.0670	1-1/2	3/8
20607000	26076	-	50	.0700	1-1/2	3/8
20607300	26082	-	49	.0730	1-1/2	3/8
20607600	26088	-	48	.0760	1-1/2	1/2
20607810	26091	5/64	-	.0781	1-1/2	1/2
20607850	26094	-	47	.0785	1-1/2	1/2
20608100	26100	-	46	.0810	1-1/2	1/2
20608200	26103	-	45	.0820	1-1/2	1/2
20608600	26109	-	44	.0860	2	1/2
20608900	26115	-	43	.0890	2	1/2
20609350	26121	-	42	.0935	2	1/2
20609380	26124	3/32	-	.0938	2	1/2
20609600	26130	-	41	.0960	2	1/2
20609800	26133	-	40	.0980	2	5/8
20609950	26139	-	39	.0995	2	5/8
20610150	26142	-	38	.1015	2	5/8
20610400	26148	-	37	.1040	2	5/8
20610650	26154	-	36	.1065	2	5/8
20610940	26157	7/64	-	.1094	2	5/8

Tool No.	EDP	Diameter			OAL	Flute Length
		D				
		Inch	Wire	Decimal	L1	L2
20611000	26160	-	35	.1100	2	5/8
20611100	26166	-	34	.1110	2	5/8
20611300	26169	-	33	.1130	2	5/8
20611600	26175	-	32	.1160	2	5/8
20612000	26181	-	31	.1200	2	5/8
20612500	26187	1/8	-	.1250	2	5/8

Inch	
D	Tolerance
.0400 - .1250	+ .0000/- .0005



See full line catalog or visit www.maford.com for complete offering.



Series 207



- Designed for drilling Carbon Fiber Reinforced Polymer (CFRP), graphite and aramid fiber (kevlar) reinforced composite materials.
- No delamination.
- Eliminate fuzz or “fray” at exit.
- Brad and spur point.

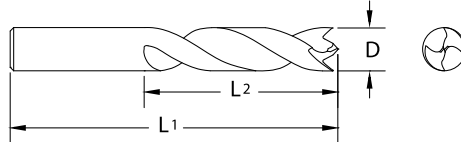

Tool No.	EDP	Diameter				OAL		Flute Length	
		D				L1		L2	
		Inch	Wire	mm	Decimal	Inch	mm	Inch	mm
20709350	27001	-	42	-	.0935	1-3/4	-	1/2	-
20709380	27004	3/32	-	-	.0938	1-3/4	-	1/2	-
20709450	27007	-	-	2.40	.0945	-	44	-	12.5
20709600	27010	-	41	-	.0960	1-13/16	-	1/2	-
20709800	27013	-	40	-	.0980	1-13/16	-	1/2	-
20709840	27016	-	-	2.50	.0984	-	46	-	12.5
20709950	27019	-	39	-	.0995	1-13/16	-	1/2	-
20710150	27022	-	38	-	.1015	1-13/16	-	1/2	-
20710240	27025	-	-	2.60	.1024	-	46	-	12.5
20710400	27028	-	37	-	.1040	1-13/16	-	1/2	-
20710630	27031	-	-	2.70	.1063	-	46	-	12.5
20710650	27034	-	36	-	.1065	1-13/16	-	1/2	-
20710940	27037	7/64	-	-	.1094	1-13/16	-	1/2	-
20711000	27040	-	35	-	.1100	1-7/8	-	5/8	-
20711020	27043	-	-	2.80	.1102	-	48	-	16.0
20711100	27046	-	34	-	.1110	1-7/8	-	5/8	-
20711300	27049	-	33	-	.1130	1-7/8	-	5/8	-
20711420	27052	-	-	2.90	.1142	-	48	-	16.0
20711600	27055	-	32	-	.1160	1-7/8	-	5/8	-
20711810	27058	-	-	3.00	.1181	-	48	-	16.0
20712000	27061	-	31	-	.1200	1-7/8	-	5/8	-
20712200	27064	-	-	3.10	.1220	-	48	-	16.0
20712500	27067	1/8	-	-	.1250	1-7/8	-	5/8	-

Inch	
D	Tolerance
.0935 - .1250	+ .0000/- .0005

Metric (mm)	
D	Tolerance
2.40 - 3.10	+ .000/- .013



See full line catalog or visit www.maford.com for complete offering.

Series 224

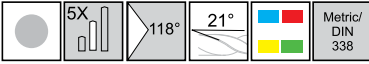

- Designed to allow high feed rates with good chip flow.
- Four facet drill point minimizes drill wander and assures accurately sized holes.

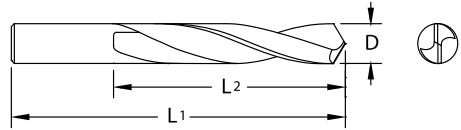

Series 224

Twister® GP

MICRO Drills

2 Flute

Tool No.	EDP	Diameter		OAL	Flute Length
		D			
		mm	Decimal		
22401180	24002	0.30	.0118	26	3
22401380	24008	0.35	.0138	26	4
22401570	24017	0.40	.0157	26	5
22401770	24023	0.45	.0177	26	5
22401970	24029	0.50	.0197	26	6
22402170	24038	0.55	.0217	26	7
22402360	24044	0.60	.0236	26	7
22402560	24053	0.65	.0256	26	8
22402760	24059	0.70	.0276	28	9
22402950	24068	0.75	.0295	28	9
22403150	24077	0.80	.0315	30	10
22403350	24086	0.85	.0335	30	10
22403540	24092	0.90	.0354	32	11
22403740	24101	0.95	.0374	32	11
22403940	24110	1.00	.0394	34	12
22404130	24119	1.05	.0413	34	12
22404330	24128	1.10	.0433	36	14
22404520	24131	1.15	.0452	36	14
22404720	24140	1.20	.0472	38	16
22404920	24143	1.25	.0492	38	16
22405110	24146	1.30	.0511	38	16
22405310	24152	1.35	.0531	40	18
22405510	24158	1.40	.0551	40	18
22405710	24161	1.45	.0571	40	18
22405900	24164	1.50	.0590	40	18
22406300	24173	1.60	.0630	43	20
22406690	24179	1.70	.0669	43	20
22407080	24188	1.80	.0708	46	22
22407480	24194	1.90	.0748	46	22
22407870	24206	2.00	.0787	49	24

Tool No.	EDP	Diameter		OAL	Flute Length
		D			
		mm	Decimal		
22408270	24215	2.10	.0827	49	24
22408660	24221	2.20	.0866	53	27
22409060	24227	2.30	.0906	53	27
22409450	24236	2.40	.0945	57	30
22409840	24245	2.50	.0984	57	30
22410240	24254	2.60	.1024	57	30
22410630	24260	2.70	.1063	61	33
22411020	24272	2.80	.1102	61	33
22411420	24281	2.90	.1142	61	33
22411810	24287	3.00	.1181	61	33

Metric (mm)	
D	Tolerance
0.30 - 3.00	+ .000/- .013



See full line catalog or visit www.maford.com for complete offering.



Series 226

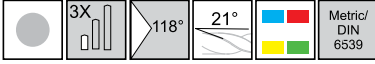

- Recommended for drilling cast iron, aluminum, bronze and magnesium alloys and other abrasive, but easily machined materials.
- Designed to allow high feed rates with good chip flow.
- Four facet drill point minimizes drill wander and assures accurately sized holes.
- Shorter length reduces deflection and vibration, increases drill accuracy and improves tool life.

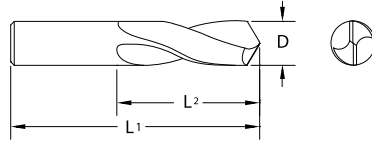

Tool No.	EDP	Diameter		OAL	Flute Length
		D			
		mm	Decimal	L1	L2
22603940	26002	1.00	.0394	26	6
22604130	26011	1.05	.0413	28	7
22604330	26020	1.10	.0433	28	7
22604520	26023	1.15	.0452	30	8
22604720	26032	1.20	.0472	30	8
22604920	26035	1.25	.0492	30	8
22605110	26038	1.30	.0511	30	8
22605310	26044	1.35	.0531	32	9
22605510	26050	1.40	.0551	32	9
22605710	26053	1.45	.0571	32	9
22605900	26056	1.50	.0590	32	9
22606300	26065	1.60	.0630	34	10
22606690	26071	1.70	.0669	34	10
22607080	26080	1.80	.0708	36	11
22607480	26086	1.90	.0748	36	11
22607870	26098	2.00	.0787	38	12
22608270	26107	2.10	.0827	38	12
22608660	26113	2.20	.0866	40	13
22609060	26119	2.30	.0906	40	13
22609450	26128	2.40	.0945	43	14
22609840	26137	2.50	.0984	43	14
22610240	26146	2.60	.1024	43	14
22610630	26152	2.70	.1063	46	16
22611020	26164	2.80	.1102	46	16
22611420	26173	2.90	.1142	46	16
22611810	26179	3.00	.1181	46	16

Metric (mm)	
D	Tolerance
1.00 - 3.00	+ .000/- .013

See full line catalog or visit www.maford.com for complete offering.



Series 300

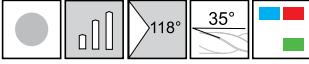

- Designed for drilling soft metals as well as glass reinforced circuit boards, phenolic-epoxies and other abrasive, but easily machined materials.
- Size range .0135-.2500" See full line catalog or visit www.maford.com for complete offering.
- Over 150 sizes available.

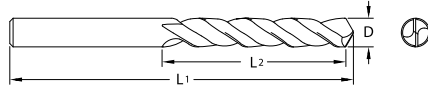

Tool No.	EDP	Diameter				OAL		Flute Length	
		D				L1		L2	
		Inch	Letter/Wire	mm	Decimal	Inch	mm	Inch	mm
30001350	30001	-	80	-	.0135	1-1/2	-	1/4	-
30001450	30005	-	79	-	.0145	1-1/2	-	1/4	-
30001560	30009	1/64	-	-	.0156	1-1/2	-	1/4	-
30001600	30013	-	78	-	.0160	1-1/2	-	1/4	-
30001800	30017	-	77	-	.0180	1-1/2	-	1/4	-
30001970	30021	-	-	0.50	.0197	-	38	-	9.5
30002000	30025	-	76	-	.0200	1-1/2	-	3/8	-
30002100	30029	-	75	-	.0210	1-1/2	-	3/8	-
30002170	30033	-	-	0.55	.0217	-	38	-	9.5
30002250	30037	-	74	-	.0225	1-1/2	-	3/8	-
30002360	30041	-	-	0.60	.0236	-	38	-	9.5
30002400	30045	-	73	-	.0240	1-1/2	-	3/8	-
30002500	30049	-	72	-	.0250	1-1/2	-	1/2	-
30002560	30053	-	-	0.65	.0256	-	38	-	12.5
30002600	30057	-	71	-	.0260	1-1/2	-	1/2	-
30002760	30061	-	-	0.70	.0276	-	38	-	12.5
30002800	30065	-	70	-	.0280	1-1/2	-	1/2	-
30002920	30069	-	69	-	.0292	1-1/2	-	1/2	-
30002950	30073	-	-	0.75	.0295	-	38	-	12.5
30003100	30077	-	68	-	.0310	1-1/2	-	1/2	-
30003120	30081	1/32	-	-	.0312	1-1/2	-	1/2	-
30003150	30085	-	-	0.80	.0315	-	38	-	12.5
30003200	30089	-	67	-	.0320	1-1/2	-	1/2	-
30003300	30093	-	66	-	.0330	1-1/2	-	1/2	-
30003350	30097	-	-	0.85	.0335	-	38	-	12.5
30003500	30101	-	65	-	.0350	1-1/2	-	5/8	-
30003540	30105	-	-	0.90	.0354	-	38	-	16.0
30003600	30109	-	64	-	.0360	1-1/2	-	5/8	-
30003700	30113	-	63	-	.0370	1-1/2	-	5/8	-
30003740	30117	-	-	0.95	.0374	-	38	-	16.0

Inch	
D	Tolerance
.0135 - .1250	+.0000/-0.0005

Metric (mm)	
D	Tolerance
0.50 - 3.15	+.000/-0.013





Series 300 Continued

Tool No.	EDP	Diameter				OAL		Flute Length	
		D				L1		L2	
		Inch	Letter/Wire	mm	Decimal	Inch	mm	Inch	mm
30003800	30121	-	62	-	.0380	1-1/2	-	5/8	-
30003900	30125	-	61	-	.0390	1-1/2	-	5/8	-
30003940	30129	-	-	1.00	.0394	-	38	-	16.0
30004000	30133	-	60	-	.0400	1-1/2	-	5/8	-
30004100	30137	-	59	-	.0410	1-1/2	-	5/8	-
30004130	30141	-	-	1.05	.0413	-	38	-	16.0
30004200	30145	-	58	-	.0420	1-1/2	-	5/8	-
30004300	30149	-	57	-	.0430	1-1/2	-	5/8	-
30004330	30153	-	-	1.10	.0433	-	38	-	16.0
30004520	30157	-	-	1.15	.0452	-	38	-	16.0
30004650	30161	-	56	-	.0465	1-1/2	-	5/8	-
30004690	30165	3/64	-	-	.0469	1-1/2	-	5/8	-
30004720	30169	-	-	1.20	.0472	-	38	-	16.0
30004920	30173	-	-	1.25	.0492	-	38	-	16.0
30005110	30177	-	-	1.30	.0511	-	38	-	16.0
30005200	30181	-	55	-	.0520	1-1/2	-	5/8	-
30005310	30185	-	-	1.35	.0531	-	38	-	16.0
30005500	30189	-	54	-	.0550	1-1/2	-	5/8	-
30005510	30193	-	-	1.40	.0551	-	38	-	16.0
30005710	30197	-	-	1.45	.0571	-	38	-	16.0
30005900	30201	-	-	1.50	.0590	-	38	-	16.0
30005950	30205	-	53	-	.0595	1-1/2	-	5/8	-
30006100	30209	-	-	1.55	.0610	-	38	-	16.0
30006250	30213	1/16	-	-	.0625	1-1/2	-	5/8	-
30006300	30217	-	-	1.60	.0630	-	38	-	16.0
30006350	30221	-	52	-	.0635	1-1/2	-	5/8	-
30006490	30225	-	-	1.65	.0649	-	38	-	16.0
30006690	30229	-	-	1.70	.0669	-	38	-	16.0
30006700	30233	-	51	-	.0670	1-1/2	-	5/8	-
30006890	30237	-	-	1.75	.0689	-	38	-	16.0
30007000	30241	-	50	-	.0700	1-1/2	-	5/8	-
30007080	30245	-	-	1.80	.0708	-	38	-	16.0
30007280	30249	-	-	1.85	.0728	-	38	-	16.0
30007300	30253	-	49	-	.0730	1-1/2	-	5/8	-
30007480	30257	-	-	1.90	.0748	-	38	-	16.0
30007600	30261	-	48	-	.0760	1-1/2	-	5/8	-
30007670	30265	-	-	1.95	.0767	-	38	-	16.0
30007810	30269	5/64	-	-	.0781	1-1/2	-	5/8	-
30007850	30273	-	47	-	.0785	1-1/2	-	5/8	-
30007870	30277	-	-	2.00	.0787	-	38	-	16.0
30008070	30281	-	-	2.05	.0807	-	38	-	16.0

Series 300

Twister® GP



MICRO Drills





Series 300 Continued

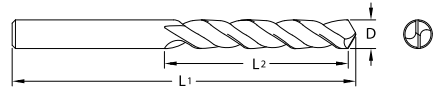

Series 300

Twister® GP

2 Flute

MICRO Drills

Tool No.	EDP	Diameter				OAL		Flute Length	
		D				L1		L2	
		Inch	Letter/Wire	mm	Decimal	Inch	mm	Inch	mm
30008100	30285	-	46	-	.0810	1-1/2	-	5/8	-
30008200	30289	-	45	-	.0820	1-1/2	-	5/8	-
30008270	30293	-	-	2.10	.0827	-	38	-	16.0
30008460	30297	-	-	2.15	.0846	-	38	-	16.0
30008600	30301	-	44	-	.0860	1-1/2	-	5/8	-
30008660	30305	-	-	2.20	.0866	-	38	-	16.0
30008860	30309	-	-	2.25	.0886	-	38	-	16.0
30008900	30313	-	43	-	.0890	1-1/2	-	5/8	-
30009060	30317	-	-	2.30	.0906	-	38	-	16.0
30009250	30321	-	-	2.35	.0925	-	38	-	16.0
30009350	30325	-	42	-	.0935	1-1/2	-	5/8	-
30009380	30329	3/32	-	-	.0938	1-1/2	-	5/8	-
30009450	30333	-	-	2.40	.0945	-	38	-	16.0
30009600	30337	-	41	-	.0960	1-1/2	-	5/8	-
30009650	30341	-	-	2.45	.0965	-	38	-	16.0
30009800	30345	-	40	-	.0980	1-1/2	-	5/8	-
30009840	30349	-	-	2.50	.0984	-	38	-	16.0
30009950	30353	-	39	-	.0995	1-1/2	-	5/8	-
30010040	30357	-	-	2.55	.1004	-	38	-	16.0
30010150	30361	-	38	-	.1015	1-1/2	-	5/8	-
30010240	30365	-	-	2.60	.1024	-	38	-	16.0
30010400	30369	-	37	-	.1040	1-1/2	-	5/8	-
30010430	30371	-	-	2.65	.1043	-	38	-	16.0
30010630	30373	-	-	2.70	.1063	-	38	-	16.0
30010650	30377	-	36	-	.1065	1-1/2	-	5/8	-
30010830	30381	-	-	2.75	.1083	-	38	-	16.0
30010940	30385	7/64	-	-	.1094	1-1/2	-	5/8	-
30011000	30389	-	35	-	.1100	1-1/2	-	5/8	-
30011020	30393	-	-	2.80	.1102	-	38	-	16.0
30011100	30397	-	34	-	.1110	1-1/2	-	5/8	-
30011220	30401	-	-	2.85	.1122	-	38	-	16.0
30011300	30405	-	33	-	.1130	1-1/2	-	5/8	-
30011420	30409	-	-	2.90	.1142	-	38	-	16.0
30011600	30413	-	32	-	.1160	1-1/2	-	5/8	-
30011610	30415	-	-	2.95	.1161	-	38	-	16.0
30011810	30417	-	-	3.00	.1181	-	38	-	16.0
30012000	30421	-	31	-	.1200	1-1/2	-	5/8	-
30012010	30423	-	-	3.05	.1201	-	38	-	16.0
30012200	30425	-	-	3.10	.1220	-	38	-	16.0
30012400	30427	-	-	3.15	.1240	-	38	-	16.0
30012500	30429	1/8	-	-	.1250	1-1/2	-	5/8	-

See full line catalog or visit www.maford.com for complete offering.



Series 302

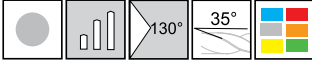

- Micro drills are manufactured in up to 3 different flute lengths, depending on diameter.
- Drills available with color coded depth setting rings upon request.

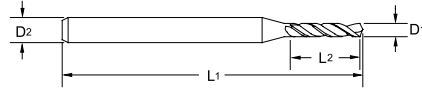

Tool No.	EDP	Diameter				Shank		OAL		Flute Length	
		D1				D2		L1		L2	
		Inch	Letter/Wire	mm	Decimal	Inch	mm	Inch	mm	Inch	mm
30200390	32001	-	102	0.10	.0039	1/8	3.175	1-1/2	38	.065	1.70
30200430	32005	-	101	-	.0043	1/8	-	1-1/2	-	.065	-
30200470	32009	-	100	-	.0047	1/8	-	1-1/2	-	.065	-
30200510	32013	-	99	-	.0051	1/8	-	1-1/2	-	.065	-
30200550	32017	-	98	-	.0055	1/8	-	1-1/2	-	.065	-
30200590	32021	-	97	0.15	.0059	1/8	3.175	1-1/2	38	.100	2.50
30200600	32025	-	-	-	.0060	1/8	-	1-1/2	-	.100	-
30200630	32029	-	96	-	.0063	1/8	-	1-1/2	-	.100	-
30200670	32033	-	95	-	.0067	1/8	-	1-1/2	-	.100	-
30200700	32037	-	-	-	.0070	1/8	-	1-1/2	-	.100	-
30200710	32041	-	94	-	.0071	1/8	-	1-1/2	-	.100	-
30200750	32045	-	93	-	.0075	1/8	-	1-1/2	-	.100	-
30200780	32049	-	-	0.20	.0078		3.175	-	38	-	3.20
30200790	32053	-	92	-	.0079	1/8	-	1-1/2	-	.125	-
30200800	32057	-	-	-	.0080	1/8	-	1-1/2	-	.125	-
30200830	32061	-	91	-	.0083	1/8	-	1-1/2	-	.125	-
30200870	32065	-	90	-	.0087	1/8	-	1-1/2	-	.125	-
30200900	32069	-	-	-	.0090	1/8	-	1-1/2	-	.125	-
30200910	32073	-	89	-	.0091	1/8	-	1-1/2	-	.125	-
30200950	32077	-	88	-	.0095	1/8	-	1-1/2	-	.125	-
30200980	32081	-	-	0.25	.0098		3.175	-	38	-	3.80
30201000	32085	-	87	-	.0100	1/8	--	1-1/2	-	.150	-
30201050	32089	-	86	-	.0105	1/8	-	1-1/2	-	.150	-
30201100	32093	-	85	-	.0110	1/8	-	1-1/2	-	.150	-
30201150	32097	-	84	-	.0115	1/8	-	1-1/2	-	.150	-

Inch	
D1	Tolerance
≤ 0.010	+0.000/-0.003
> 0.010	+0.000/-0.005
L1	Tolerance
≤ 0.010	+/-0.005
> 0.010	+/-0.005
D2	Tolerance
≤ .125	+0.000/-0.002

Metric (mm)	
D1	Tolerance
≤ 0.25	+0.000/-0.008
> 0.25	+0.000/-0.013
L1	Tolerance
≤ 0.25	+/-0.130
> 0.25	+/-0.130
D2	Tolerance
≤ 3.18	+0.000/-0.005





Series 302 Continued

Tool No.	EDP	Diameter				Shank		OAL		Flute Length	
		D1				D2		L1		L2	
		Inch	Letter/Wire	mm	Decimal	Inch	mm	Inch	mm	Inch	mm
30201180	32101	-	-	0.3	.0118		3.175	-	38	-	4.8
30201200	32105	-	83	-	.012	1/8	-	1-1/2	-	0.19	-
30201250	32109	-	82	-	.0125	1/8	-	1-1/2	-	0.19	-
30201300	32113	-	81	-	.013	1/8	-	1-1/2	-	0.19	-
30201350	32117	-	80	-	.0135	1/8	-	1-1/2	-	0.19	-
30201351	32119	-	80	-	.0135	1/8	-	1-1/2	-	0.25	-
30201380	32121	-	-	0.35	.0138	-	3.175	-	38	-	4.8
30201381	32123	-	-	0.35	.0138	-	3.175	-	38	-	6.35
30201450	32125	-	79	-	.0145	1/8	-	1-1/2	-	.190	-
30201451	32127	-	79	-	.0145	1/8	-	1-1/2	-	.250	-
30201560	32129	1/64	-	-	.0156	1/8	-	1-1/2	-	.190	-
30201561	32131	1/64	-	-	.0156	1/8	-	1-1/2	-	.250	-
30201570	32133	-	-	0.40	.0157	-	3.175	-	38	-	4.80
30201571	32135	-	-	0.40	.0157	-	3.175	-	38	-	6.35
30201600	32137	-	78	-	.0160	1/8	-	1-1/2	-	.190	-
30201601	32139	-	78	-	.0160	1/8	-	1-1/2	-	.250	-
30201770	32141	-	-	0.45	.0177	-	3.175	-	38	-	4.80
30201771	32143	-	-	0.45	.0177	-	3.175	-	38	-	6.35
30201772	32144	-	-	0.45	.0177	-	3.175	-	38	-	8.13
30201800	32145	-	77	-	.0180	1/8	-	1-1/2	-	.190	-
30201801	32147	-	77	-	.0180	1/8	-	1-1/2	-	.250	-
30201802	32148	-	77	-	.0180	1/8	-	1-1/2	-	.320	-
30201970	32149	-	-	0.50	.0197	-	3.175	-	38	-	4.80
30201971	32151	-	-	0.50	.0197	-	3.175	-	38	-	6.35
30201972	32152	-	-	0.50	.0197	-	3.175	-	38	-	8.13
30202000	32153	-	76	-	.0200	1/8	-	1-1/2	-	.190	-
30202001	32155	-	76	-	.0200	1/8	-	1-1/2	-	.250	-
30202002	32156	-	76	-	.0200	1/8	-	1-1/2	-	.320	-
30202100	32157	-	75	-	.0210	1/8	-	1-1/2	-	.190	-
30202101	32159	-	75	-	.0210	1/8	-	1-1/2	-	.250	-
30202102	32160	-	75	-	.0210	1/8	-	1-1/2	-	.320	-
30202170	32161	-	-	0.55	.0217	-	3.175	-	38	-	4.80
30202171	32163	-	-	0.55	.0217	-	3.175	-	38	-	6.35
30202172	32164	-	-	0.55	.0217	-	3.175	-	38	-	8.13
30202250	32165	-	74	-	.0225	1/8	-	1-1/2	-	.190	-
30202251	32167	-	74	-	.0225	1/8	-	1-1/2	-	.250	-
30202252	32168	-	74	-	.0225	1/8	-	1-1/2	-	.320	-
30202360	32169	-	-	0.60	.0236	-	3.175	-	38	-	4.80
30202361	32171	-	-	0.60	.0236	-	3.175	-	38	-	6.35
30202362	32172	-	-	0.60	.0236	-	3.175	-	38	-	8.13
30202400	32173	-	73	-	.0240	1/8	-	1-1/2	-	.190	-
30202401	32175	-	73	-	.0240	1/8	-	1-1/2	-	.250	-

Series 302

Twister® GP

2 Flute

MICRO Drills





Series 302 Continued

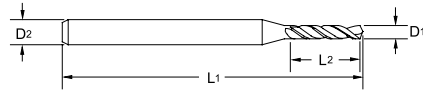

Tool No.	EDP	Diameter				Shank		OAL		Flute Length	
		D1				D2		L1		L2	
		Inch	Letter/Wire	mm	Decimal	Inch	mm	Inch	mm	Inch	mm
30202402	32176	-	73	-	.0240	1/8	-	1-1/2	-	.320	-
30202500	32177	-	72	-	.0250	1/8	-	1-1/2	-	.190	-
30202501	32179	-	72	-	.0250	1/8	-	1-1/2	-	.250	-
30202502	32180	-	72	-	.0250	1/8	-	1-1/2	-	.320	-
30202560	32181	-	-	0.65	.0256	-	3.175	-	38	-	4.80
30202561	32183	-	-	0.65	.0256	-	3.175	-	38	-	6.35
30202562	32184	-	-	0.65	.0256	-	3.175	-	38	-	8.13
30202600	32185	-	71	-	.0260	1/8	-	1-1/2	-	.190	-
30202601	32187	-	71	-	.0260	1/8	-	1-1/2	-	.250	-
30202602	32188	-	71	-	.0260	1/8	-	1-1/2	-	.320	-
30202760	32189	-	-	0.70	.0276	-	3.175	-	38	-	6.35
30202761	32191	-	-	0.70	.0276	-	3.175	-	38	-	8.13
30202762	32192	-	-	0.70	.0276	-	3.175	-	38	-	10.16
30202800	32193	-	70	-	.0280	1/8	-	1-1/2	-	.250	-
30202801	32195	-	70	-	.0280	1/8	-	1-1/2	-	.320	-
30202802	32196	-	70	-	.0280	1/8	-	1-1/2	-	.400	-
30202920	32197	-	69	-	.0292	1/8	-	1-1/2	-	.250	-
30202921	32199	-	69	-	.0292	1/8	-	1-1/2	-	.320	-
30202922	32200	-	69	-	.0292	1/8	-	1-1/2	-	.400	-
30202950	32201	-	-	0.75	.0295	-	3.175	-	38	-	6.35
30202951	32203	-	-	0.75	.0295	-	3.175	-	38	-	8.13
30202952	32204	-	-	0.75	.0295	-	3.175	-	38	-	10.16
30203100	32205	-	68	-	.0310	1/8	-	1-1/2	-	.250	-
30203101	32207	-	68	-	.0310	1/8	-	1-1/2	-	.400	-
30203120	32209	1/32	-	-	.0312	1/8	-	1-1/2	-	.250	-
30203121	32211	1/32	-	-	.0312	1/8	-	1-1/2	-	.400	-
30203150	32213	-	-	0.80	.0315	-	3.175	-	38	-	6.35
30203151	32215	-	-	0.80	.0315	-	3.175	-	38	-	10.16
30203200	32217	-	67	-	.0320	1/8	-	1-1/2	-	.250	-
30203201	32219	-	67	-	.0320	1/8	-	1-1/2	-	.400	-
30203300	32221	-	66	-	.0330	1/8	-	1-1/2	-	.250	-
30203301	32223	-	66	-	.0330	1/8	-	1-1/2	-	.400	-
30203350	32225	-	-	0.85	.0335	-	3.175	-	38	-	6.35
30203351	32227	-	-	0.85	.0335	-	3.175	-	38	-	10.16
30203500	32229	-	65	-	.0350	1/8	-	1-1/2	-	.400	-
30203540	32233	-	-	0.90	.0354	-	3.175	-	38	-	10.16
30203600	32237	-	64	-	.0360	1/8	-	1-1/2	-	.400	-
30203700	32241	-	63	-	.0370	1/8	-	1-1/2	-	.400	-
30203740	32245	-	-	0.95	.0374	-	3.175	-	38	-	10.16
30203800	32249	-	62	-	.0380	1/8	-	1-1/2	-	.400	-
30203900	32253	-	61	-	.0390	1/8	-	1-1/2	-	.400	-
30203940	32257	-	-	1.00	.0394	-	3.175	-	38	-	10.16

Series 302

Twister® GP



MICRO Drills



Page 62



Series 302 Continued

Tool No.	EDP	Diameter				Shank		OAL		Flute Length	
		D1				D2		L1		L2	
		Inch	Letter/Wire	mm	Decimal	Inch	mm	Inch	mm	Inch	mm
30204000	32261	-	60	-	.0400	1/8	-	1-1/2	-	.400	-
30204100	32265	-	59	-	.0410	1/8	-	1-1/2	-	.400	-
30204130	32269	-	-	1.05	.0413	-	3.175	-	38	-	10.16
30204200	32273	-	58	-	.0420	1/8	-	1-1/2	-	.400	-
30204300	32277	-	57	-	.0430	1/8	-	1-1/2	-	.400	-
30204330	32281	-	-	1.10	.0433	-	3.175	-	38	-	10.16
30204520	32285	-	-	1.15	.0452	-	3.175	-	38	-	10.16
30204650	32289	-	56	-	.0465	1/8	-	1-1/2	-	.400	-
30204690	32293	3/64	-	-	.0469	1/8	-	1-1/2	-	.400	-
30204720	32297	-	-	1.20	.0472	-	3.175	-	38	-	10.16
30204920	32301	-	-	1.25	.0492	-	3.175	-	38	-	10.16
30205110	32305	-	-	1.30	.0511	-	3.175	-	38	-	10.16
30205200	32309	-	55	-	.0520	1/8	-	1-1/2	-	.400	-
30205310	32313	-	-	1.35	.0531	-	3.175	-	38	-	10.16
30205500	32317	-	54	-	.0550	1/8	-	1-1/2	-	.400	-
30205510	32321	-	-	1.40	.0551	-	3.175	-	38	-	10.16
30205710	32325	-	-	1.45	.0571	-	3.175	-	38	-	10.16
30205900	32329	-	-	1.50	.0590	-	3.175	-	38	-	10.16
30205950	32333	-	53	-	.0595	1/8	-	1-1/2	-	.400	-
30206100	32341	-	-	1.55	.0610	-	3.175	-	38	-	10.16
30206250	32345	1/16	-	-	.0625	1/8	-	1-1/2	-	.480	-
30206300	32349	-	-	1.60	.0630	-	3.175	-	38	-	12.19
30206350	32353	-	52	-	.0635	1/8	-	1-1/2	-	.480	-
30206490	32357	-	-	1.65	.0649	-	3.175	-	38	-	12.19
30206690	32361	-	-	1.70	.0669	-	3.175	-	38	-	12.19
30206700	32365	-	51	-	.0670	1/8	-	1-1/2	-	.480	-
30206890	32369	-	-	1.75	.0689	-	3.175	-	38	-	12.19
30207000	32373	-	50	-	.0700	1/8	-	1-1/2	-	.480	-
30207080	32377	-	-	1.80	.0708	-	3.175	-	38	-	12.19
30207280	32381	-	-	1.85	.0728	-	3.175	-	38	-	12.19
30207300	32385	-	49	-	.0730	1/8	-	1-1/2	-	.480	-
30207480	32389	-	-	1.90	.0748	-	3.175	-	38	-	12.19
30207600	32393	-	48	-	.0760	1/8	-	1-1/2	-	.480	-
30207670	32397	-	-	1.95	.0767	-	3.175	-	38	-	12.19
30207810	32401	5/64	-	-	.0781	1/8	-	1-1/2	-	.480	-
30207850	32405	-	47	-	.0785	1/8	-	1-1/2	-	.480	-
30207870	32409	-	-	2.00	.0787	-	3.175	-	38	-	12.19
30208070	32413	-	-	2.05	.0807	-	3.175	-	38	-	12.19
30208100	32417	-	46	-	.0810	1/8	-	1-1/2	-	.480	-
30208200	32421	-	45	-	.0820	1/8	-	1-1/2	-	.480	-
30208270	32425	-	-	2.10	.0827	-	3.175	-	38	-	12.19
30208460	32429	-	-	2.15	.0846	-	3.175	-	38	-	12.19

Series 302

Twister® GP

2 Flute

MICRO Drills



Page 62



Series 302 Continued

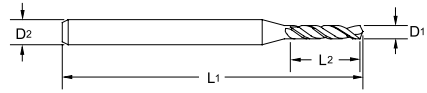

Tool No.	EDP	Diameter				Shank		OAL		Flute Length	
		D1				D2		L1		L2	
		Inch	Letter/Wire	mm	Decimal	Inch	mm	Inch	mm	Inch	mm
30208600	32433	-	44	-	.0860	1/8	-	1-1/2	-	.480	-
30208660	32437	-	-	2.20	.0866	-	3.175	-	38	-	12.19
30208860	32441	-	-	2.25	.0886	-	3.175	-	38	-	12.19
30208900	32445	-	43	-	.0890	1/8	-	1-1/2	-	.480	-
30209060	32449	-	-	2.30	.0906	-	3.175	-	38	-	12.19
30209250	32453	-	-	2.35	.0925	-	3.175	-	38	-	12.19
30209350	32457	-	42	-	.0935	1/8	-	1-1/2	-	.480	-
30209380	32461	3/32	-	-	.0938	1/8	-	1-1/2	-	.480	-
30209450	32465	-	-	2.40	.0945	-	3.175	-	38	-	12.19
30209600	32469	-	41	-	.0960	1/8	-	1-1/2	-	.480	-
30209650	32473	-	-	2.45	.0965	-	3.175	-	38	-	12.19
30209800	32477	-	40	-	.0980	1/8	-	1-1/2	-	.480	-
30209840	32481	-	-	2.50	.0984	-	3.175	-	38	-	12.19
30209950	32485	-	39	-	.0995	1/8	-	1-1/2	-	.480	-
30210040	32489	-	-	2.55	.1004	-	3.175	-	38	-	12.19
30210150	32493	-	38	-	.1015	1/8	-	1-1/2	-	.480	-
30210240	32497	-	-	2.60	.1024	-	3.175	-	38	-	12.19
30210400	32501	-	37	-	.1040	1/8	-	1-1/2	-	.480	-
30210430	32503	-	-	2.65	.1043	-	3.175	-	38	-	12.19
30210630	32509	-	-	2.70	.1063	-	3.175	-	38	-	12.19
30210650	32513	-	36	-	.1065	1/8	-	1-1/2	-	.480	-
30210830	32517	-	-	2.75	.1083	-	3.175	-	38	-	12.19
30210940	32521	7/64	-	-	.1094	1/8	-	1-1/2	-	.480	-
30211000	32525	-	35	-	.1100	1/8	-	1-1/2	-	.480	-
30211020	32529	-	-	2.80	.1102	-	3.175	-	38	-	12.19
30211100	32533	-	34	-	.1110	1/8	-	1-1/2	-	.480	-
30211220	32537	-	-	2.85	.1122	-	3.175	-	38	-	12.19
30211300	32541	-	33	-	.1130	1/8	-	1-1/2	-	.480	-
30211420	32545	-	-	2.90	.1142	-	3.175	-	38	-	12.19
30211600	32549	-	32	-	.1160	1/8	-	1-1/2	-	.480	-
30211610	32551	-	-	2.95	.1161	-	3.175	-	38	-	12.19
30211810	32553	-	-	3.00	.1181	-	3.175	-	38	-	12.19
30212000	32557	-	31	-	.1200	1/8	-	1-1/2	-	.480	-
30212010	32559	-	-	3.05	.1201	-	3.175	-	38	-	12.19
30212200	32561	-	-	3.10	.1220	-	3.175	-	38	-	12.19
30212400	32565	-	-	3.15	.1240	-	3.175	-	38	-	12.19
30212500	32569	1/8	-	-	.1250	1/8	-	1-1/2	-	.480	-

Series 302

Twister® GP



MICRO Drills



Series 402



- Designed to maintain accurate center holes on long production runs, or when precise centering is required.
- 60° included angle.
- Solid carbide construction helps reduce tool changes when centering abrasive or difficult to machine materials.

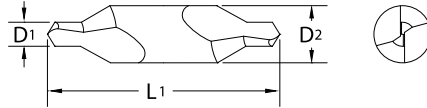
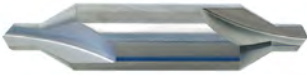

Series 402

Twister® GP

MICRO Drills

2 Flute

Tool No.	EDP	Diameter			Shank		OAL	
		D1			D2		L1	
		Size	Inch	mm	Inch	mm	Inch	mm
40201970	40201	-	-	0.5	-	3.15	-	31.5*
40202500	40205	00	.025	-	1/8	-	1-1/2	-
40203100	40209	0	1/32	-	1/8	-	1-1/2	-
40203150	40213	-	-	0.8	-	3.15	-	31.5*
40203940	40217	-	-	1.0	-	3.15	-	31.5
40204680	40221	1	3/64	-	1/8	-	1-1/2	-
40204920	40225	-	-	1.25	-	3.15	-	31.5
40206300	40229	-	-	1.6	-	4.0	-	35.5
40207810	40233	2	5/64	-	3/16	-	1-7/8	-
40207870	40237	-	-	2.0	-	5.0	-	40
40209840	40241	-	-	2.5	-	6.3	-	45
40210930	40245	3	7/64	-	1/4	-	2	-
40212400	40249	-	-	3.15	-	8.0	-	50
40212500	40253	4	1/8	-	5/16	-	2-1/8	-

*Overall length not to DIN specifications.

Inch		Metric (mm)	
D1	Tolerance	D1	Tolerance
.0250 - 1/8	+ .003/- .000	0.50 - 3.15	+ .076/- .000



Page 64

See full line catalog or visit www.maford.com for complete offering.



Series 405



- Designed to maintain accurate center holes on long production runs or when precise centering is required.
- 60° included angle.
- Solid carbide construction helps reduce tool changes when centering abrasive or difficult to machine materials.

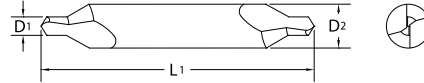

Tool No.	EDP	D1		Shank	OAL
		Size	Inch	D2	L1
40502500	40501	00	.0250	1/8	5
40503100	40505	0	1/32	1/8	5
40504680	40509	1	3/64	1/8	5
40507810	40513	2	5/64	3/16	5
40510930	40517	3	7/64	1/4	5
40512500	40521	4	1/8	5/16	5

Inch	
D1	Tolerance
.0250 - 1/8	+.003/- .000



See full line catalog or visit www.maford.com for complete offering.



High Performance Drill Selection Chart

See 2020 Catalog or visit www.maford.com for full offering of high performance drills.



Our industry leading high performance drill with the same high quality that helped set the standard.



Multipurpose high quality drill for most drilling applications adding stability, hole quality, tool life, and finish (excludes some work hardening materials).



An economical choice perfect for job shop and batch production work requiring a high performance drill option.

Series	Drill Lgth	Size Range Inch	Size Range mm	Margin	D1 Tol.	D2 Tol.	Helix	Point Angle	Coolant Fed	DIN	Coating	Application Recommendations							
												TEMA* Sizes	Steel	Hardened Steel	Stainless Steel	PH Stainless Steel	Cast Iron	Titanium	High Temp Alloys
CXDSS	3X	#31-3/4	3.0-20.0	Double	m7	h6	30°	140°	N	6537K	ALtima® Plus	X	1st	2nd	2nd	2nd	1st	2nd	2nd
CXDSR	5X	#31-5/8	3.0-16.0	Double	m7	h6	30°	140°	N	6537L	ALtima® Plus	X	1st	2nd	2nd	2nd	1st	2nd	2nd
CXDSC	3X	#31-5/8	3.0-16.0	Double	m7	h6	30°	140°	Y	6537K	ALtima® Plus	X	1st	2nd	1st	2nd	1st	1st	2nd
CXDRC	5X	#31-3/4	3.0-20.0	Double	m7	h6	30°	140°	Y	6537L	ALtima® Plus	X	1st	2nd	1st	2nd	1st	1st	2nd
CXDCL	8X	#31-1/2	3.0-12.0	Double	m7	h6	30°	140°	Y		ALtima® Plus	X	1st	2nd	1st	2nd	1st	1st	2nd
CXDCE	15X	#31-15/32	3.0-12.0	Double	h7	h6	30°	140°	Y		ALtima® Plus		1st	2nd	1st	2nd	1st	1st	2nd
2XDSS	3X	#31-3/4	2.5-20.0	Single	h7	h6	30°	142°	N		ALtima®	X	2nd	1st	1st	1st	2nd	1st	1st
2XDSC	5X	1/64-5/8	0.5-16.0	Single	h7	h6	30°	142°	N		ALtima®	X	2nd	1st	1st	1st	2nd	1st	1st
2XDSC	3X	#31-5/8	3.0-16.0	Single	h7	h6	30°	142°	Y	6537K	ALtima®	X	2nd	1st	1st	1st	2nd	2nd	1st
2XDRC	5X	#31-3/4	3.0-20.0	Single	h7	h6	30°	142°	Y		ALtima®	X	2nd	1st	1st	1st	2nd	2nd	1st
2XDCL	7X+	#31-1/2	3.0-12.0	Single	h7	h6	30°	142°	Y		ALtima®	X	2nd	1st	1st	1st	2nd	2nd	1st
2XDCE	12X-25X**	1/4 - 1/2	5.0-12.0	Double	h7	h6	30°	142°	Y		ALtima®		2nd	1st	1st	1st	2nd	2nd	1st
HPDSR	5X	#31-5/8	3.0-16.0	Single	h7	h6	30°	140°	N	6537L	HP ALTiN		3rd	3rd	3rd	3rd	3rd	3rd	3rd
HPDCR	5X	#31-5/8	3.0-16.0	Single	h7	h6	30°	140°	Y	6537L	HP ALTiN		3rd	3rd	3rd	3rd	3rd	3rd	3rd

Note: For drilling applications involving cross holes and/or optimal hole finishes, use the CXD style drill.

*TEMA - Tubular Exchange Manufacturer's Association

**Length varies depending on size.

Inch		Inch	
D1	Tolerance (m7)	D1	Tolerance (h7)
.0000 - .1181	+ .00008/+ .00047	.0000 - .1181	+0/- .00039
.1182 - .2362	+ .00016/+ .00063	.1182 - .2362	+0/- .00047

Inch		Inch	
D1	Tolerance (m7)	D1	Tolerance (h7)
.0000 - .1181	+ .00008/+ .00047	.0000 - .1181	+0/- .00039
.1182 - .2362	+ .00016/+ .00063	.1182 - .2362	+0/- .00047

Inch		Inch	
D2	Tolerance (h6)	D2	Tolerance (h6)
.0000 - .1181	+0/- .00024	.0000 - .1181	+0/- .00024
.1182 - .2362	+0/- .00031	.1182 - .2362	+0/- .00031

Metric (mm)		Metric (mm)	
D1	Tolerance (m7)	D1	Tolerance (h7)
0 - 3.0	+ .002/+ .012	0 - 3.0	+0/- .010
3.01 - 6.0	+ .004/+ .016	3.01 - 6.0	+0/- .012

Metric (mm)		Metric (mm)	
D1	Tolerance (m7)	D1	Tolerance (h7)
0 - 3.0	+ .002/+ .012	0 - 3.0	+0/- .010
3.01 - 6.0	+ .004/+ .016	3.01 - 6.0	+0/- .012

Metric (mm)		Metric (mm)	
D2	Tolerance (h6)	D2	Tolerance (h6)
0 - 3.0	+0/- .006	0 - 3.0	+0/- .006
3.01 - 6.0	+0/- .008	3.01 - 6.0	+0/- .008

M.A. Ford® Coating	Microhardness (HV)	Maximum Service Temp.	Friction Coefficient
ALtima®	3100	1100° C / 2012° F	0.42
ALtima® Plus	3200	1100° C / 2012° F	0.25

Technical data provided should be considered advisory only as variations may be necessary depending on the particular application.



Twister® Drill Icon Glossary

	Solid	Workpiece Material Group	
	Coolant Fed		
	Drill Length		
	Drill Point Angle		
	Helix Angle		
	Coatings		
>3mm DIN 6537L icon"/>	DIN Specs		

Cutting Calculations and Definitions		Metric	U.S.
ae	= Width of cut, radial depth of cut	(mm)	(inch)
ap	= Depth of cut, axial depth of cut	(mm)	(inch)
Dc	= Cutter diameter	(mm)	(inch)
f	= Feed per revolution	(mm/rev)	(IPR)
fz	= Feed per tooth	(mm/tooth)	(IPT)
zn	= Number of teeth	Number	
n	= RPM	(rev/min)	(rev/min)
Q	= Metal removal rate	(cm ³ /min)	(in ³ /min)
vc	= Cutting speed	(m/min)	(SFM)
vf	= Feed speed	(mm/min)	(IPM)
Dw	= Working diameter	(mm)	(inch)

Formulas

Inch
 $RPM (n) = SFM (vc) \times 3.82 / \text{Tool Diam.}$
 $IPM (vf) = RPM (n) \times IPR (f)$

Conversion Inch to Metric

$SFM (vc) \text{ to } m/min (vc) = SFM (vc) \times .3048$
 $IPM (vf) \text{ to } mm/min (vf) = IPM (vf) \times 25.4$

Metric

$RPM (n) = m/min (vc) \times 318.057 / \text{Tool Diam.}$
 $mm/min (vf) = RPM (n) \times mm/Revolution (f)$

Conversion Metric to Inch

$m/min (vc) \text{ to } SFM (vc) = (m/min) / .3048$
 $mm/min (vf) \text{ to } IPM (vf) = (mm/min) / 25.4$

Safety Note

Always wear the appropriate personal protective equipment such as safety glasses and protective clothing when using solid carbide or HSS cutting tools. Machines should be fully guarded.

Drill Troubleshooting

Possible Solutions	Problem																																	
	Tool Deterioration								Chip Formation		Tool Life	Workpiece				Process																		
	Flank wear	Margin wear	Breakage	Flaking	Greater wear	Chisel edge wear	Corner chipping	Flute chipping	Cutting edge chipping	Cutting edge wear	Point center chipping	Rake face	Scoring on tool body	Long stringy	Varied chip form	Blue/brown chips	Tool Life	Undersized hole	Oversized hole	Poor alignment	Poor surface finish	Heavy burr breakout	Retract marks	Hole location	Hole straightness	Deflection	Point Deflection	Galling	Vibration	Abnormal noise	Chip packing	No drill penetration		
Reduce feed or reduce at exit	x	x			x	x	x	x		x	x	x					x	x	x	x	x											x		
Reduce feed at entrance			x															x		x					x	x						x		
Consistent feed rate			x											x	x														x	x				
Increase feed	x					x				x								x	x															
Reduce speed	x	x			x	x			x								x	x										x	x	x				
Increase speed																					x													
Coolant mix		x	x	x					x				x				x	x		x	x											x		
Coolant increase flow	x	x			x	x		x							x	x	x		x	x												x		
Coolant filter	x	x	x					x									x	x		x	x											x		
Workpiece clamp rigid	x	x			x	x		x				x					x		x	x	x	x	x	x	x							x		
Collet accuracy		x						x											x						x	x				x				
Tool holder fit .0008		x						x											x						x	x				x				
Alignment		x						x											x														x	
Peck drill			x																															
Concentricity	x	x	x			x	x					x								x	x		x	x	x	x	x	x		x				
Do not extract tool during peck							x																											

Technical data provided should be considered advisory only as variations may be necessary depending on the particular application.



Recommended Cutting Data MPDCS / MXDSR / MXDCR / MXDCL Series - Inch

Workpiece Material Group	ISO	Hardness	Tool Series	TYPE	DEPTH	vc-SFM	Drill Diameter (mm)					
							0.5	1.0	1.5	2.0	2.5	2.95
							f - IPR					
Free Machining & Low Carbon Steels 1006, 1008, 1015, 1018, 1020, 1022, 1025, 1117, 1140, 1141, 11L08, 11L14, 1213, 12L13, 12L14, 1215, 1330	P	up to 28 Rc	MXDSR		5	150	.0005	.0010	.0015	.0020	.0025	.0030
			MPDCS		2	300	—	.0010	.0015	.0020	.0025	.0030
			MXDCR		5	—	.0007	.0010	.0013	.0017	.0020	
			MXDCL		12	260	.0007	.0010	.0013	.0017	.0020	
Medium Carbon & High Carbon Steels, Alloy Steels & Easy to Machine Tool Steels 1030, 1035, 1040, 1045, 1050, 1052, 1055, 1060, 1085, 1095, 1541, 1551, 9255, 2515, 3135, 3415, 4130, 4137, 4140, 4150, 4320, 4340, 4520, 5015, 5115, 5120, 5132, 5140, 5155, 6150, 8620, 9262, 9840, 52100, O1, O2, O6, S2, W1 to W310	P	28 to 38 Rc	MXDSR		5	130	.0005	.0010	.0015	.0020	.0025	.0030
			MPDCS		2	300	—	.0010	.0015	.0020	.0025	.0030
			MXDCR		5	—	.0007	.0010	.0013	.0017	.0020	
			MXDCL		12	260	.0007	.0010	.0013	.0017	.0020	
Tool Steels & Die Steels O7, M1, M2, M3, M4, M7, T1, T2, T4, T5, T8, T15, A2, A3, A6, A7, H10, H11, H12, H13, H19, H21, L3, L6, L7, P2, P20, S1, S5, S7, 52100, A128, D2, D3, D4, D5, D7	P	28 to 44 Rc	MXDSR		5	120	.0005	.0010	.0015	.0020	.0025	.0030
			MPDCS		2	250	—	.0010	.0015	.0020	.0025	.0030
			MXDCR		5	—	.0007	.0010	.0013	.0017	.0020	
			MXDCL		12	230	.0007	.0010	.0013	.0017	.0020	
Hardened Steels A2 / 52100	H	45 to 55 Rc	MXDSR		5	50	.0002	.0004	.0007	.0009	.0011	.0014
			MPDCS		2	—	.0004	.0007	.0009	.0011	.0014	
			MXDCR		5	80	—	.0002	.0004	.0006	.0008	.0010
			MXDCL		12	—	.0002	.0004	.0006	.0008	.0010	
Stainless Steel - Easy to Machine 430F, 301, 303, 410, 416 Annealed, 420F, 430	M	up to 28 Rc	MXDSR		5	140	.0005	.0010	.0015	.0020	.0025	.0030
			MPDCS		2	300	—	.0010	.0015	.0020	.0025	.0030
			MXDCR		5	—	.0007	.0010	.0013	.0017	.0020	
			MXDCL		12	260	.0007	.0010	.0013	.0017	.0020	
Stainless Steel - Moderately Difficult 301, 302, 303 High Tensile, 304, 304L, 305, 420, 15-5PH, 17-4PH, 17-7PH	M	up to 28 Rc	MXDSR		5	125	.0005	.0010	.0015	.0020	.0025	.0030
			MPDCS		2	230	—	.0008	.0012	.0016	.0020	.0023
			MXDCR		5	—	.0007	.0010	.0013	.0017	.0020	
			MXDCL		12	—	.0007	.0010	.0013	.0017	.0020	
Stainless Steel - Difficult to Machine 302B, 304B, 309, 310, 316, 316B, 316L, 316Ti, 317, 317L, 321, PH13-8Mo, Nitronics	M	over 28 Rc	MXDSR		5	60	.0002	.0004	.0007	.0009	.0011	.0014
			MPDCS		2	80	—	.0004	.0007	.0009	.0011	.0014
			MXDCR		5	—	.0002	.0004	.0006	.0008	.0010	
			MXDCL		12	—	.0002	.0004	.0006	.0008	.0010	

Technical data provided should be considered advisory only as variations may be necessary depending on the particular application.



Recommended Cutting Data MPDCS / MXDSR / MXDCR / MXDCL Series - Inch continued

Workpiece Material Group	ISO	Hardness	Tool Series	TYPE	DEPTH	vc-SFM	Drill Diameter (mm)					
							0.5	1.0	1.5	2.0	2.5	2.95
							f - IPR					
Cast Iron - Gray CG, ASTM A48, CLASS 20, 25, 30, 35, SAE J431C, GRADES G1800, G3000, G3500, GG 10, 15, 20, 25, 30, 35, 40	K	up to 240 HB	MXDSR		5	150	.0005	.0010	.0015	.0020	.0025	.0030
			MPDCS		2							
			MXDCR		5	325	—	.0010	.0015	.0020	.0025	.0030
			MXDCL		12							
Cast Iron - Ductile & Malleable CGI: 60-40-18, 65-45-12, D4018, D4512, D5506, 32510, 35108, M3210, M4504, M5503, 250, 300, 350, 400, 450	K	over 240 HB	MXDSR		5	150	.0005	.0010	.0015	.0020	.0025	.0030
			MPDCS		2							
			MXDCR		5	250	—	.0010	.0015	.0020	.0025	.0030
			MXDCL		12							
Titanium 6Al-4V	S	up to 40 Rc	MXDSR		5	70	.0005	.0010	.0015	.0020	.0025	.0030
			MPDCS		2							
			MXDCR		5	230	—	.0004	.0006	.0008	.0010	.0012
			MXDCL		12							
High Temp Alloys Inconel / Hastelloy / Waspeloy / Nickel Based Alloys - Monel	S	up to 40 Rc	MXDSR		5	60	.0002	.0004	.0007	.0009	.0011	.0014
			MPDCS		2							
			MXDCR		5	155	—	.0004	.0006	.0008	.0010	.0012
			MXDCL		12							

Recommended Peck Depths For MXDSR Solid Drilling by Diameter*

Diameter	Peck Depth
0.50 mm	.2 x Diameter
1.00 mm	.3 x Diameter
1.50 mm	.6 x Diameter
2.00 mm	.8 x Diameter
2.50 mm	1.0 x Diameter
2.95 mm	3.0 x Diameter

*Peck depths can vary by material type.

Recommended Machine Requirements

- High Pressure Pump System (1,000 psi / 68.9 bar)
- Coolant filtration of 10 microns or better
- Total runout of .0004" (.01 mm) Max. at drill tip

For best MXDCL performance, the following steps are recommended:

- When Drilling with the MXDCL, drill a pilot hole 1.5 - 2 x diameter deep using a MPDCS drill.
- Insert MXDCL into pilot hole at a low speed (300-500 RPM) stopping short of the pilot hole bottom.
- Start coolant flow and increase speed to recommended RPM.
- Feed to full depth. (Pecking may be required for standard coolant pressure. Follow the MXDSR peck depth chart. To prevent drill whip and corner damage, do not retract all the way out of hole while pecking.)
- After reaching desired depth, reduce speed (300-500 RPM) before retracting from the hole at a feed of 2-4 times the drilling feed.

Note: Under optimal conditions (high pressure coolant), one shot drilling may be accomplished with the MXDCL.

Technical data provided should be considered advisory only as variations may be necessary depending on the particular application.



Recommended Cutting Data MPDCS / MXDSR / MXDCR / MXDCL Series - Metric

Workpiece Material Group	ISO	Hardness	Tool Series	TYPE	DEPTH	vc- m/min.	Drill Diameter (mm)					
							0.5	1.0	1.5	2.0	2.5	2.95
							f - mm/Rev					
Free Machining & Low Carbon Steels 1006, 1008, 1015, 1018, 1020, 1022, 1025, 1117, 1140, 1141, 11L08, 11L14, 1213, 12L13, 12L14, 1215, 1330	P	up to 28 Rc	MXDSR		5	45	.013	.025	.038	.051	.064	.076
			MPDCS		2	90	—	.025	.038	.051	.064	.076
			MXDCR		5	—	.025	.038	.051	.064	.076	
			MXDCL		12	80	.017	.026	.034	.043	.050	
Medium Carbon & High Carbon Steels, Alloy Steels & Easy to Machine Tool Steels 1030, 1035, 1040, 1045, 1050, 1052, 1055, 1060, 1085, 1095, 1541, 1551, 9255, 2515, 3135, 3415, 4130, 4137, 4140, 4150, 4320, 4340, 4520, 5015, 5115, 5120, 5132, 5140, 5155, 6150, 8620, 9262, 9840, 52100, 01, 02, 06, S2, W1 to W310	P	28 to 38 Rc	MXDSR		5	40	.013	.025	.038	.051	.064	.076
			MPDCS		2	90	—	.025	.038	.051	.064	.076
			MXDCR		5	—	.025	.038	.051	.064	.076	
			MXDCL		12	80	.017	.026	.034	.043	.050	
Tool Steels & Die Steels 07, M1, M2, M3, M4, M7, T1, T2, T4, T5, T8, T15, A2, A3, A6, A7, H10, H11, H12, H13, H19, H21, L3, L6, L7, P2, P20, S1, S5, S7, 52100, A128, D2, D3, D4, D5, D7	P	28 to 44 Rc	MXDSR		5	35	.013	.025	.038	.051	.064	.076
			MPDCS		2	75	—	.025	.038	.051	.064	.076
			MXDCR		5	—	.025	.038	.051	.064	.076	
			MXDCL		12	70	.017	.026	.034	.043	.050	
Hardened Steels A2 / 52100	H	45 to 55 Rc	MXDSR		5	15	.005	.010	.018	.023	.028	.036
			MPDCS		2	—	.010	.018	.023	.028	.036	
			MXDCR		5	25	—	.010	.018	.023	.028	.036
			MXDCL		12	—	.005	.010	.015	.020	.025	
Stainless Steel - Easy to Machine 430F, 301, 303, 410, 416 Annealed, 420F, 430	M	up to 28 Rc	MXDSR		5	40	.013	.025	.038	.051	.064	.076
			MPDCS		2	90	—	.025	.038	.051	.064	.076
			MXDCR		5	—	.025	.038	.051	.064	.076	
			MXDCL		12	80	.017	.026	.034	.043	.050	
Stainless Steel - Moderately Difficult 301, 302, 303 High Tensile, 304, 304L, 305, 420, 15-5PH, 17-4PH, 17-7PH	M	up to 28 Rc	MXDSR		5	38	.013	.025	.038	.051	.064	.076
			MPDCS		2	—	.020	.030	.040	.050	.059	
			MXDCR		5	70	—	.020	.030	.040	.050	.059
			MXDCL		12	—	.017	.026	.034	.043	.050	
Stainless Steel - Difficult to Machine 302B, 304B, 309, 310, 316, 316B, 316L, 316Ti, 317, 317L, 321, PH13-8Mo, Nitronics	M	over 28 Rc	MXDSR		5	18	.005	.010	.018	.023	.028	.036
			MPDCS		2	—	.010	.018	.023	.028	.036	
			MXDCR		5	25	—	.010	.018	.023	.028	.036
			MXDCL		12	—	.005	.010	.015	.020	.025	

Technical data provided should be considered advisory only as variations may be necessary depending on the particular application.



Recommended Cutting Data MPDCS / MXDSR / MXDCR / MXDCL Series - Metric continued

Workpiece Material Group	I S O	Hardness	Tool Series	T Y P E	D E P T H	vc- m/min	Drill Diameter (mm)					
							0.5	1.0	1.5	2.0	2.5	2.95
							f - mm/Rev					
Cast Iron - Gray CG, ASTM A48, CLASS 20, 25, 30, 35, SAE J431C, GRADES G1800, G3000, G3500, GG 10, 15, 20, 25, 30, 35, 40	K	up to 240 HB	MXDSR		5	45	.013	.025	.038	.051	.064	.076
			MPDCS		2							
			MXDCR		5	100	—	.025	.038	.051	.064	.076
			MXDCL		12							
Cast Iron - Ductile & Malleable CGI: 60-40-18, 65-45-12, D4018, D4512, D5506, 32510, 35108, M3210, M4504, M5503, 250, 300, 350, 400, 450	K	over 240 HB	MXDSR		5	45	.013	.025	.038	.051	.064	.076
			MPDCS		2							
			MXDCR		5	75	—	.025	.038	.051	.064	.076
			MXDCL		12							
Titanium 6Al-4V	S	up to 40 Rc	MXDSR		5	20	.013	.025	.038	.051	.064	.076
			MPDCS		2							
			MXDCR		5	70	—	.010	.015	.020	.025	.030
			MXDCL		12							
High Temp Alloys Inconel / Hastelloy / Waspeloy / Nickel Based Alloys - Monel	S	up to 40 Rc	MXDSR		5	18	.005	.010	.018	.023	.028	.036
			MPDCS		2							
			MXDCR		5	47	—	.010	.015	.020	.025	.030
			MXDCL		12							

Recommended Peck Depths For MXDSR Solid Drilling by Diameter*

Diameter	Peck Depth
0.50 mm	.2 x Diameter
1.00 mm	.3 x Diameter
1.50 mm	.6 x Diameter
2.00 mm	.8 x Diameter
2.50 mm	1.0 x Diameter
2.95 mm	3.0 x Diameter

*Peck depths can vary by material type.

Recommended Machine Requirements

- High Pressure Pump System (1,000 psi / 68.9 bar)
- Coolant filtration of 10 microns or better
- Total runout of .0004" (.01mm) Max. at drill tip

For best MXDCL performance, the following steps are recommended:

- When Drilling with the MXDCL, drill a pilot hole 1.5 - 2 x diameter deep using a MPDCS drill.
- Insert MXDCL into pilot hole at a low speed (300-500 RPM) stopping short of the pilot hole bottom.
- Start coolant flow and increase speed to recommended RPM.
- Feed to full depth. (Pecking may be required for standard coolant pressure. Follow the MXDSR peck depth chart. To prevent drill whip and corner damage, do not retract all the way out of hole while pecking.)
- After reaching desired depth, reduce speed (300-500 RPM) before retracting from the hole at a feed of 2-4 times the drilling feed.

Note: Under optimal conditions (high pressure coolant), one shot drilling may be accomplished with the MXDCL

Technical data provided should be considered advisory only as variations may be necessary depending on the particular application.



Recommended Cutting Data 2MDCL - Inch

Workpiece Material Group	I S O	Hardness	T Y P E	D E P T H	Drill Diameter			Drill Diameter		
					0.0787	0.0984	0.1142	0.0787	0.0984	0.1142
					vc - SFM			f - IPR		
Free Machining & Low Carbon Steels 1006, 1008, 1015, 1018, 1020, 1022, 1025, 1117, 1140, 1141, 11L08, 11L14, 1213, 12L13, 12L14, 1215, 1330	P	up to 28 Rc		10X	300	300	250	.0018	.0020	.0022
Medium Carbon & High Carbon Steels, Alloy Steels & Easy to Machine Tool Steels 1030, 1035, 1040, 1045, 1050, 1052, 1055, 1060, 1085, 1095, 1541, 1551, 9255, 2515, 3135, 3415, 4130, 4137, 4140, 4150, 4320, 4340, 4520, 5015, 5115, 5120, 5132, 5140, 5155, 6150, 8620, 9262, 9840, 52100, O1, O2, O6, S2, W1 to W310	P	28 to 38 Rc		10X	300	300	250	.0018	.0020	.0022
Tool Steels & Die Steels O7, M1, M2, M3, M4, M7, T1, T2, T4, T5, T8, T15, A2, A3, A6, A7, H10, H11, H12, H13, H19, H21, L3, L6, L7, P2, P20, S1, S5, S7, 52100, A128, D2, D3, D4, D5, D7	P	28 to 44 Rc		10X	250	250	200	.0018	.0020	.0022
Stainless Steel - Easy to Machine 430F, 301, 303, 410, 416 Annealed, 420F, 430	M	up to 28 Rc		10X	300	300	250	.0018	.0020	.0022
Stainless Steel - Moderately Difficult 301, 302, 303 High Tensile, 304, 304L, 305, 420, 15-5PH, 17-4PH, 17-7PH	M	up to 28 Rc		10X	230	230	200	.0018	.0020	.0022
Stainless Steel - Difficult to Machine 302B, 304B, 309, 310, 316, 316B, 316L, 316Ti, 317, 317L, 321, PH13-8Mo, Nitronics	M	over 28 Rc		10X	60	60	50	.0009	.0011	.0015
High Temp Alloys Nimonic, Inconel, Monel, Hastelloy	S	up to 42 Rc		10X	50	50	40	.0009	.0011	.0014
Titanium Alloys 6Al-4V, 5Al-2.5 Sn, 6Al-2 Sn-4Zr-6Mo, 3Al-8V-6Cr4Mo-4Zr, 10V-2Fe-3Al, 13V-11Cr-3Al	S	up to 42 Rc		10X	175	175	150	.0009	.0011	.0014
Cast Iron - Gray CG, ASTM A48, CLASS 20, 25, 30, 35, SAE J431C, GRADES G1800, G3000, G3500, GG 10, 15, 20, 25, 30, 35, 40	K	up to 240 HB		10X	325	325	300	.0018	.0020	.0022
Cast Iron - Ductile & Malleable CGI 60-40-18, 65-45-12, D4018, D4512, D5506, 32510, 35108, M3210, M4504, M5503, 250, 300, 350, 400, 450	K	over 240 HB		10X	250	250	200	.0018	.0020	.0022

M.A. Ford[®] recommends full retraction of the body of the drill from the hole during the peck cycle. It is recommended to leave the drill point within the hole.

For hole depths deeper than 4x the diameter, M.A. Ford[®] recommends using a "soft start" program that drills to .5x diameter deep at 2/3 of the speed and feed.

Machine Requirements

High Pressure Pump System (1,000 psi/68.9 bar)
Coolant filtration of 10 microns or better
Machine runout of .0004" (.01mm) Max.

Estimated Peck Depths

For hole depths up to 6X diameter No Pecks
For hole depths up to 10X diameter 0-2 Pecks
For hole depths up to 15X diameter 2-4 Pecks

Technical data provided should be considered advisory only as variations may be necessary depending on the particular application.



Recommended Cutting Data 2MDCL - Metric

Workpiece Material Group	I S O	Hardness	T Y P E	D E P T H	Drill Diameter (mm)			Drill Diameter (mm)		
					2.0	2.5	2.9	2.0	2.5	2.9
					vc - m/min			f - mm/Rev		
Free Machining & Low Carbon Steels 1006, 1008, 1015, 1018, 1020, 1022, 1025, 1117, 1140, 1141, 11L08, 11L14, 1213, 12L13, 12L14, 1215, 1330	P	up to 28 Rc		10X	90	90	75	.046	.051	.056
Medium Carbon & High Carbon Steels, Alloy Steels & Easy to Machine Tool Steels 1030, 1035, 1040, 1045, 1050, 1052, 1055, 1060, 1085, 1095, 1541, 1551, 9255, 2515, 3135, 3415, 4130, 4137, 4140, 4150, 4320, 4340, 4520, 5015, 5115, 5120, 5132, 5140, 5155, 6150, 8620, 9262, 9840, 52100, O1, O2, O6, S2, W1 to W310	P	28 to 38 Rc		10X	90	90	75	.046	.051	.056
Tool Steels & Die Steels O7, M1, M2, M3, M4, M7, T1, T2, T4, T5, T8, T15, A2, A3, A6, A7, H10, H11, H12, H13, H19, H21, L3, L6, L7, P2, P20, S1, S5, S7, 52100, A128, D2, D3, D4, D5, D7	P	28 to 44 Rc		10X	60	60	53	.046	.051	.056
Stainless Steel - Easy to Machine 430F, 301, 303, 410, 416 Annealed, 420F, 430	M	up to 28 Rc		10X	90	90	75	.046	.051	.056
Stainless Steel - Moderately Difficult 301, 302, 303 High Tensile, 304, 304L, 305, 420, 15-5PH, 17-4PH, 17-7PH	M	up to 28 Rc		10X	75	75	60	.033	.038	.043
Stainless Steel - Difficult to Machine 302B, 304B, 309, 310, 316, 316B, 316L, 316Ti, 317, 317L, 321, PH13-8Mo, Nitronics	M	over 28 Rc		10X	18	18	15	.025	.027	.038
High Temp Alloys Nimonic, Inconel, Monel, Hastelloy	S	up to 42 Rc		10X	15	15	12	.025	.027	.036
Titanium Alloys 6Al-4V, 5Al-2.5 Sn, 6Al-2 Sn-4Zr-6Mo, 3Al-8V-6Cr-4Mo-4Zr, 10V-2Fe-3Al, 13V-11Cr-3Al	S	up to 42 Rc		10X	55	55	45	.025	.027	.036
Cast Iron - Gray CG, ASTM A48, CLASS 20, 25, 30, 35, SAE J431C, GRADES G1800, G3000, G3500, GG 10, 15, 20, 25, 30, 35, 40	K	up to 240 HB		10X	100	100	90	.046	.051	.065
Cast Iron - Ductile & Malleable CGI 60-40-18, 65-45-12, D4018, D4512, D5506, 32510, 35108, M3210, M4504, M5503, 250, 300, 350, 400, 450	K	over 240 HB		10X	75	75	60	.046	.051	.056

M.A. Ford® recommends full retraction of the body of the drill from the hole during the peck cycle. It is recommended to leave the drill point within the hole.

For hole depths deeper than 4x the diameter, M.A. Ford® recommends using a "soft start" program that drills to .5x diameter deep at 2/3 of the speed and feed.

Machine Requirements

High Pressure Pump System (1,000 psi/68.9 bar)
Coolant filtration of 10 microns or better
Machine runout of .0004" (.01mm) Max.

Estimated Peck Depths

For hole depths up to 6X diameter No Pecks
For hole depths up to 10X diameter 0-2 Pecks
For hole depths up to 15X diameter 2-4 Pecks

Technical data provided should be considered advisory only as variations may be necessary depending on the particular application.



Recommended Cutting Data 229 - Inch

Workpiece Material Group	I S O	T Y P E	D E P T H	vc - SFM	Drill Diameter	
					3/64	
					f - IPR	
Non-Ferrous - Al < 14% Si	N		5	700	.003	
Non-Ferrous - Al > 14% Si	N		5	500	.002	
Non-Ferrous - Brass	N		5	400	.002	
Non-Ferrous - Cu/Cu Alloys/Magnesium	N		5	300	.002	

Recommended Cutting Data 229 - Metric

Workpiece Material Group	I S O	T Y P E	D E P T H	vc - m/min	Drill Diameter (mm)	
					1.5	3
					f - mm/Rev	
Non-Ferrous - Al < 14% Si	N		5	215	.080	.200
Non-Ferrous - Al > 14% Si	N		5	155	.050	.080
Non-Ferrous - Brass	N		5	120	.050	.080
Non-Ferrous - Cu/Cu Alloys/Magnesium	N		5	90	.050	.080

Technical data provided should be considered advisory only as variations may be necessary depending on the particular application.



Recommended Cutting Data 305 Micro-Tuff® - Inch

Workpiece Material Group	ISO	Hardness	Tool Series	TYPE	VC - SFM	Drill Diameter				
						1/64	1/32	1/16	3/32	1/8
						f - IPR				
Free Machining & Low Carbon Steels: 1006, 1008, 1015, 1018, 1020, 1022, 1025, 1117, 1140, 1141, 11L08, 11L14, 1213, 12L13, 12L14, 1215, 1330	P	up to 28 Rc	305	●	300	.0004	.0008	.0015	.0023	.0030
			305AM		360					
Medium Carbon & High Carbon Steels, Alloy Steels & Easy to Machine Tool Steels: 1030, 1035, 1040, 1045, 1050, 1052, 1055, 1060, 1085, 1095, 1541, 1551, 9255, 2515, 3135, 3415, 4130, 4137, 4140, 4150, 4320, 4340, 4520, 5015, 5115, 5120, 5132, 5140, 5155, 6150, 8620, 9262, 9840, 52100, O1, O2, O6, S2, W1 to W310	P	28 to 38 Rc	305	●	225	.0004	.0008	.0015	.0023	.0030
			305AM		270					
Tool Steels & Die Steels: O7, M1, M2, M3, M4, M7, T1, T2, T4, T5, T8, T15, A2, A3, A6, A7, H10, H11, H12, H13, H19, H21, L3, L6, L7, P2, P20, S1, S5, S7, 52100, A128, D2, D3, D4, D5, D7	P	28 to 44 Rc	305	●	200	.0004	.0008	.0015	.0023	.0030
			305AM		240					
Hardened Steels A2 / 52100	H	35-55 Rc	305	●	50	.0002	.0004	.0007	.0011	.0014
			305AM		60					
Free Machining Stainless	M	up to 28 Rc	305	●	175	.0004	.0008	.0015	.0023	.0030
			305AM		210					
Stainless Steel - Austenitic 304 / 316	M	up to 28 Rc	305	●	200	.0004	.0008	.0015	.0023	.0030
			305AM		240					
Stainless Steel - Ferritic / Martensitic	M	up to 28 Rc	305	●	100	.0004	.0008	.0015	.0023	.0030
			305AM		120					
Stainless Steel - Moderately Difficult: 301, 302, 303 High Tensile, 304, 304L, 305, 420, 15-5PH, 17-4PH, 17-7PH	M	over 28 Rc	305	●	75	.0004	.0008	.0015	.0023	.0030
			305AM		90					
Aluminum (<10% Si)	N		305	●	450	.0005	.0010	.0020	.0030	.0040
			305AM		-					
Aluminum (>10% Si)	N		305	●	325	.0005	.0010	.0020	.0030	.0040
			305AM		-					
Plastics	N		305	●	550	.0005	.0010	.0020	.0030	.0040
			305AM		-					
Composites / Fiber Reinforced Materials / Circuit Boards	N		305	●	650	.0005	.0010	.0020	.0030	.0040
			305AM		-					
Cast Iron - Gray CG: ASTM A48, CLASS 20, 25, 30, 35, SAE J431C, GRADES G1800, G3000, G3500, GG 10, 15, 20, 25, 30, 35, 40	K	up to 240 HB	305	●	400	.0004	.0008	.0015	.0023	.0030
			305AM		480					
Cast Iron - Ductile & Malleable CGI: 60-40-18, 65-45-12, D4018, D4512, D5506, 32510, 35108, M3210, M4504, M5503, 250, 300, 350, 400, 450	K	over 240 HB	305	●	350	.0004	.0008	.0015	.0023	.0030
			305AM		420					
Titanium 6Al-4V	S	up to 40 Rc	305	●	60	.0004	.0008	.0015	.0023	.0030
			305AM		70					
High Temp Alloys Inconel / Hastelloy / Waspeloy / Nickel Based Alloys-Monel	S	up to 40 Rc	305	●	50	.0002	.0004	.0007	.0011	.0014
			305AM		60					

Recommended Peck Depths by Diameter*

Diameter	Peck Depth
1/64	.2 x Diameter
1/32	.3 x Diameter
1/16	.6 x Diameter
5/64	.8 x Diameter
3/32	1.0 x Diameter
1/8	1.2 x Diameter

*Peck depths can vary by material type.

Technical data provided should be considered advisory only as variations may be necessary depending on the particular application.



Recommended Cutting Data 305 Micro-Tuff® - Metric

Technical Information

MICRO Drills

Workpiece Material Group	I S O	Hardness	Tool Series	T Y P E	vc - m/ min	Drill Diameter (mm)				
						0.5	1	2	2.5	3
						f - mm/Rev				
Free Machining & Low Carbon Steels: 1006, 1008, 1015, 1018, 1020, 1022, 1025, 1117, 1140, 1141, 11L08, 11L14, 1213, 12L13, 12L14, 1215, 1330	P	up to 28 Rc	305	●	90	.10	.020	.040	.060	.075
			305AM		110					
Medium Carbon & High Carbon Steels, Alloy Steels & Easy to Machine Tool Steels: 1030, 1035, 1040, 1045, 1050, 1052, 1055, 1060, 1085, 1095, 1541, 1551, 9255, 2515, 3135, 3415, 4130, 4137, 4140, 4150, 4320, 4340, 4520, 5015, 5115, 5120, 5132, 5140, 5155, 6150, 8620, 9262, 9840, 52100, O1, O2, O6, S2, W1 to W310	P	28 to 38 Rc	305	●	70	.10	.020	.040	.060	.075
			305AM		84					
Tool Steels & Die Steels: O7, M1, M2, M3, M4, M7, T1, T2, T4, T5, T8, T15, A2, A3, A6, A7, H10, H11, H12, H13, H19, H21, L3, L6, L7, P2, P20, S1, S5, S7, 52100, A128, D2, D3, D4, D5, D7	P	28 to 44 Rc	305	●	60	.10	.020	.040	.060	.075
			305AM		72					
Hardened Steels A2 / 52100	H	35-55 Rc	305	●	15	.005	.010	.020	.025	.035
			305AM		18					
Free Machining Stainless	M	up to 28 Rc	305	●	55	.10	.020	.040	.060	.075
Stainless Steel - Austenitic 304 / 316	M	up to 28 Rc	305		66					
			305AM		72					
Stainless Steel - Ferritic / Martensitic	M	up to 28 Rc	305	30	.10	.020	.040	.060	.075	
Stainless Steel - Moderately Difficult: 301, 302, 303 High Tensile, 304, 304L, 305, 420, 15-5PH, 17-4PH, 17-7PH	M	over 28 Rc	305AM	36						
			305AM	25						
Aluminum (<10% Si)	N		305	●	140	.015	.025	.050	.075	.100
			305AM		-					
Aluminum (>10% Si)	N		305	●	100	.015	.025	.050	.075	.100
			305AM		-					
Plastics	N		305	●	170	.015	.025	.050	.075	.100
			305AM		-					
Composites / Fiber Reinforced Materials / Circuit Boards	N		305	●	200	.015	.025	.050	.075	.100
			305AM		-					
Cast Iron - Gray CG: ASTM A48, CLASS 20, 25, 30, 35, SAE J431C, GRADES G1800, G3000, G3500, GG 10, 15, 20, 25, 30, 35, 40	K	up to 240 HB	305	●	120	.10	.020	.040	.060	.075
			305AM		144					
Cast Iron - Ductile & Malleable CGI: 60-40-18, 65-45-12, D4018, D4512, D5506, 32510, 35108, M3210, M4504, M5503, 250, 300, 350, 400, 450	K	over 240 HB	305	●	110	.10	.020	.040	.060	.075
			305AM		132					
Titanium 6Al-4V	S	up to 40 Rc	305	●	20	.10	.020	.040	.060	.075
			305AM		24					
High Temp Alloys Inconel / Hastelloy / Waspeloy / Nickel Based Alloys-Monel	S	up to 40 Rc	305	●	15	.005	.010	.020	.030	.035
			305AM		18					

Recommended Peck Depths by Diameter*

Diameter	Peck Depth
0.5 mm	.2 x Diameter
1.0 mm	.4 x Diameter
1.5 mm	.6 x Diameter
2.0 mm	.8 x Diameter
2.5 mm	1.0 x Diameter
3.0 mm	1.2 x Diameter

*Peck depths can vary by material type.

Technical data provided should be considered advisory only as variations may be necessary depending on the particular application.



Recommended Cutting Data 200 - Inch

Workpiece Material Group	ISO	Hardness	Tool Series	TYPE	DEPTH	vc - SFM	Drill Diameter		
							1/32	1/16	1/8
							f - IPR		
Free Machining & Low Carbon Steels 1006, 1008, 1015, 1018, 1020, 1022, 1025, 1117, 1140, 1141, 11L08, 11L14, 1213, 12L13, 12L14, 1215, 1330	P	up to 28 Rc	200		3	330	.0010	.0020	.0030
			200A		3	495	.0010	.0020	.0030
Medium Carbon & High Carbon Steels, Alloy Steels & Easy to Machine Tool Steels 1030, 1035, 1040, 1045, 1050, 1052, 1055, 1060, 1085, 1095, 1541, 1551, 9255, 2515, 3135, 3415, 4130, 4137, 4140, 4150, 4320, 4340, 4520, 5015, 5115, 5120, 5132, 5140, 5155, 6150, 8620, 9262, 9840, 52100, O1, O2, O6, S2, W1 to W310	P	28 to 38 Rc	200	●	3	265	.0010	.0020	.0030
			200A		3	395	.0010	.0020	.0030
Tool Steels & Die Steels O7, M1, M2, M3, M4, M7, T1, T2, T4, T5, T8, T15, A2, A3, A6, A7, H10, H11, H12, H13, H19, H21, L3, L6, L7, P2, P20, S1, S5, S7, 52100, A 128, D2, D3, D4, D5, D7	P	28 to 44 Rc	200		3	230	.0010	.0020	.0030
			200A		3	345	.0010	.0020	.0030
Hardened Steel	H	45 to 65 Rc	200	●	3	50	.0003	.0010	.0010
			200A		3	75	.0003	.0010	.0010
Stainless Steel - Moderately Difficult 301, 302, 303 High Tensile, 304, 304L, 305, 420, 15-5PH, 17-4PH, 17-7PH	M	up to 28 Rc	200		3	150	.0010	.0020	.0030
			200A		3	225	.0010	.0020	.0030
Stainless Steel - Difficult to Machine 302B, 304B, 309, 310, 316, 316B, 316L, 316Ti, 317, 317L, 321, PH13-8Mo, Nitronics	M	up to 28 Rc	200	●	3	100	.0003	.0005	.0020
			200A		3	150	.0003	.0005	.0020
High Temp Alloys Nimonic, Inconel, Monel, Hastelloy	S	up to 42 Rc	200		3	70	.0003	.0005	.0020
			200A		3	105	.0003	.0005	.0020
Titanium Alloys 6Al-4V, 5Al-2.5 Sn, 6Al-2 Sn-4Zr-6Mo, 3Al-8V-6Cr4Mo-4Zr, 10V-2Fe-3Al, 13V-11Cr-3Al	S	up to 42 Rc	200	●	3	180	.0003	.0005	.0020
			200A		3	270	.0003	.0005	.0020
Cast Iron - Gray CG, ASTM A48, CLASS 20, 25, 30, 35, SAE J431C, GRADES G1800, G3000, G3500, GG 10, 15, 20, 25, 30, 35, 40	K	up to 240 HB	200		3	365	.0010	.0020	.0030
			200A		3	550	.0010	.0020	.0030
Cast Iron - Ductile & Malleable CGI 60-40-18, 65-45-12, D4018, D4512, D5506, 32510, 35108, M3210, M4504, M5503, 250, 300, 350, 400, 450	K	over 240 HB	200	●	3	265	.0010	.0020	.0030
			200A		3	400	.0010	.0020	.0030
Plastics	N		200	●	3	300	.0010	.0020	.0030
			200A		3		.0010	.0020	.0030
Kevlar/Graphite	N		200	●	3	300	.0010	.0020	.0030
			200A		3		.0010	.0020	.0030

Technical Information

MICRO Drills

Technical data provided should be considered advisory only as variations may be necessary depending on the particular application.



Recommended Cutting Data 200 - Metric

Technical Information

MICRO Drills

Workpiece Material Group	I S O	Hardness	Tool Series	T Y P E	D E P T H	vc - m/min	Drill Diameter (mm)		
							1	1.5	3
							f - mm/Rev		
Free Machining & Low Carbon Steels 1006, 1008, 1015, 1018, 1020, 1022, 1025, 1117, 1140, 1141, 11L08, 11L14, 1213, 12L13, 12L14, 1215, 1330	P	up to 28 Rc	200		3	100	.0250	.0510	.0760
			200A		3	150	.0250	.0510	.0760
Medium Carbon & High Carbon Steels, Alloy Steels & Easy to Machine Tool Steels 1030, 1035, 1040, 1045, 1050, 1052, 1055, 1060, 1085, 1095, 1541, 1551, 9255, 2515, 3135, 3415, 4130, 4137, 4140, 4150, 4320, 4340, 4520, 5015, 5115, 5120, 5132, 5140, 5155, 6150, 8620, 9262, 9840, 52100, O1, O2, O6, S2, W1 to W310	P	28 to 38 Rc	200		3	80	.0250	.0510	.0760
			200A		3	120	.0250	.0510	.0760
Tool Steels & Die Steels O7, M1, M2, M3, M4, M7, T1, T2, T4, T5, T8, T15, A2, A3, A6, A7, H10, H11, H12, H13, H19, H21, L3, L6, L7, P2, P20, S1, S5, S7, 52100, A 128, D2, D3, D4, D5, D7	P	28 to 44 Rc	200		3	45	.0250	.0510	.0760
			200A		3	67	.0250	.0510	.0760
Hardened Steel	H	45 to 65 Rc	200	●	3	15	.0063	.0254	.0254
			200A		3	23	.0063	.0254	.0254
Stainless Steel - Moderately Difficult 301, 302, 303 High Tensile, 304, 304L, 305, 420, 15-5PH, 17-4PH, 17-7PH	M	up to 28 Rc	200		3	45	.0250	.0510	.0760
			200A		3	67	.0250	.0510	.0760
Stainless Steel - Difficult to Machine 302B, 304B, 309, 310, 316, 316B, 316L, 316Ti, 317, 317L, 321, PH13-8Mo, Nitronics	M	up to 28 Rc	200	●	3	30	.0060	.0130	.0510
			200A		3	45	.0060	.0130	.0510
High Temp Alloys Nimonic, Inconel, Monel, Hastelloy	S	up to 42 Rc	200		3	20	.0060	.0130	.0510
			200A		3	30	.0060	.0130	.0510
Titanium Alloys 6Al-4V, 5Al-2.5 Sn, 6Al-2 Sn-4Zr-6Mo, 3Al-8V-6Cr4Mo-4Zr, 10V-2Fe-3Al, 13V-11Cr-3Al	S	up to 42 Rc	200	●	3	55	.0060	.0130	.0510
			200A		3	82	.0060	.0130	.0510
Cast Iron - Gray CG, ASTM A48, CLASS 20, 25, 30, 35, SAE J431C, GRADES G1800, G3000, G3500, GG 10, 15, 20, 25, 30, 35, 40	K	up to 240 HB	200	●	3	110	.0250	.0510	.0760
			200A		3	165	.0250	.0510	.0760
Cast Iron - Ductile & Malleable CGI 60-40-18, 65-45-12, D4018, D4512, D5506, 32510, 35108, M3210, M4504, M5503, 250, 300, 350, 400, 450	K	over 240 HB	200	●	3	80	.0250	.0510	.0760
			200A		3	120	.0250	.0510	.0760
Plastics	N		200	●	3	90	.0250	.0510	.0760
			200A		3		.0250	.0510	.0760
Kevlar/Graphite	N		200	●	3	90	.0250	.0510	.0760
			200A		3		.0250	.0510	.0760

Technical data provided should be considered advisory only as variations may be necessary depending on the particular application.



Recommended Cutting Data 204 / 206 - Inch

Workpiece Material Group	I S O	Hardness	Tool Series	T Y P E	D E P T H	vc - SFM	Drill Diameter		
							1/32	1/16	1/8
							f - IPR		
Free Machining & Low Carbon Steels 1006, 1008, 1015, 1018, 1020, 1022, 1025, 1117, 1140, 1141, 11L08, 11L14, 1213, 12L13, 12L14, 1215, 1330	P	up to 28 Rc	206	●	3	175	.0010	.0020	.0030
			204		5				
Medium Carbon & High Carbon Steels, Alloy Steels & Easy to Machine Tool Steels 1030, 1035, 1040, 1045, 1050, 1052, 1055, 1060, 1085, 1095, 1541, 1551, 9255, 2515, 3135, 3415, 4130, 4137, 4140, 4150, 4320, 4340, 4520, 5015, 5115, 5120, 5132, 5140, 5155, 6150, 8620, 9262, 9840, 52100, O1, O2, O6, S2, W1 to W310	P	28 to 38 Rc	206	●	3	165	.0010	.0020	.0030
			204		5				
Tool Steels & Die Steels O7, M1, M2, M3, M4, M7, T1, T2, T4, T5, T8, T15, A2, A3, A6, A7, H10, H11, H12, H13, H19, H21, L3, L6, L7, P2, P20, S1, S5, S7, 52100, A 128, D2, D3, D4, D5, D7	P	28 to 44 Rc	206	●	3	150	.0010	.0020	.0030
			204		5				
Stainless Steel - Easy to Machine 430F, 301, 303, 410, 416 Annealed, 420F, 430, 430F	M	up to 28 Rc	206	●	3	195	.0010	.0020	.0030
			204		5				
Stainless Steel - Moderately Difficult 301, 302, 303 High Tensile, 304, 304L, 305, 420, 15-5PH, 17-4PH, 17-7PH	M	up to 28 Rc	206	●	3	125	.0010	.0020	.0030
			204		5				
Plastics	N		206	●	3	400	.00025	.0005	.0020
			204		5				
Kevlar/Graphite	N		206	●	3	400	.00025	.0005	.0020
			204		5				
Cast Iron - Gray CG, ASTM A48, CLASS 20, 25, 30, 35, SAE J431C, GRADES G1800, G3000, G3500, GG 10, 15, 20, 25, 30, 35, 40	K	up to 240 HB	206	●	3	275	.0010	.0020	.0030
			204		5				
Cast Iron - Ductile & Malleable CGI 60-40-18, 65-45-12, D4018, D4512, D5506, 32510, 35108, M3210, M4504, M5503, 250, 300, 350, 400, 450	K	over 240 HB	206	●	3	175	.0010	.0020	.0030
			204		5				

Technical Information
MICRO Drills

Technical data provided should be considered advisory only as variations may be necessary depending on the particular application.



Recommended Cutting Data 224 / 226 - Metric

Workpiece Material Group	ISO	Hardness	Tool Series	TYPE	DEPTH	vc - m/min	Drill Diameter (mm)		
							1	1.5	3
							f - mm/Rev		
Free Machining & Low Carbon Steels 1006, 1008, 1015, 1018, 1020, 1022, 1025, 1117, 1140, 1141, 11L08, 11L14, 1213, 12L13, 12L14, 1215, 1330	P	up to 28 Rc	226	●	3	55	.025	.050	.076
			224		5				
Medium Carbon & High Carbon Steels, Alloy Steels & Easy to Machine Tool Steels 1030, 1035, 1040, 1045, 1050, 1052, 1055, 1060, 1085, 1095, 1541, 1551, 9255, 2515, 3135, 3415, 4130, 4137, 4140, 4150, 4320, 4340, 4520, 5015, 5115, 5120, 5132, 5140, 5155, 6150, 8620, 9262, 9840, 52100, O1, O2, O6, S2, W1 to W310	P	28 to 38 Rc	226	●	3	50	.025	.050	.076
			224		5				
Tool Steels & Die Steels O7, M1, M2, M3, M4, M7, T1, T2, T4, T5, T8, T15, A2, A3, A6, A7, H10, H11, H12, H13, H19, H21, L3, L6, L7, P2, P20, S1, S5, S7, 52100, A 128, D2, D3, D4, D5, D7	P	28 to 44 Rc	226	●	3	45	.025	.050	.076
			224		5				
Stainless Steel - Easy to Machine 430F, 301, 303, 410, 416 Annealed, 420F, 430, 430F	M	up to 28 Rc	226	●	3	60	.025	.050	.076
			224		5				
Stainless Steel - Moderately Difficult 301, 302, 303 High Tensile, 304, 304L, 305, 420, 15-5PH, 17-4PH, 17-7PH	M	up to 28 Rc	226	●	3	40	.025	.050	.076
			224		5				
Plastics	N		226	●	3	120	.006	.013	.050
			224		5				
Kevlar/Graphite	N		226	●	3	120	.006	.013	.050
			224		5				
Cast Iron - Gray CG, ASTM A48, CLASS 20, 25, 30, 35, SAE J431C, GRADES G1800, G3000, G3500, GG 10, 15, 20, 25, 30, 35, 40	K	up to 240 HB	226	●	3	85	.025	.050	.076
			224		5				
Cast Iron - Ductile & Malleable CGI 60-40-18, 65-45-12, D4018, D4512, D5506, 32510, 35108, M3210, M4504, M5503, 250, 300, 350, 400, 450	K	over 240 HB	226	●	3	55	.025	.050	.076
			224		5				

Technical data provided should be considered advisory only as variations may be necessary depending on the particular application.



Recommended Cutting Data 205 / 207 - Inch

Workpiece Material Group	I S O	Hardness	Tool Series	T Y P E	D E P T H	vc - SFM	Drill Diameter		
							1/32	1/16	1/8
							f - IPR		
Free Machining & Low Carbon Steels 1006, 1008, 1015, 1018, 1020, 1022, 1025, 1117, 1140, 1141, 11L08, 11L14, 1213, 12L13, 12L14, 1215, 1330	P	up to 28 Rc	205		Screw Machine	175	.0010	.0020	.0030
			205T				.0010	.0020	.0030
Medium Carbon & High Carbon Steels, Alloy Steels & Easy to Machine Tool Steels 1030, 1035, 1040, 1045, 1050, 1052, 1055, 1060, 1085, 1095, 1541, 1551, 9255, 2515, 3135, 3415, 4130, 4137, 4140, 4150, 4320, 4340, 4520, 5015, 5115, 5120, 5132, 5140, 5155, 6150, 8620, 9262, 9840, 52100, O1, O2, O6, S2, 1 to W310	P	28 to 38 Rc	205		Screw Machine	165	.0010	.0020	.0030
			205T				.0010	.0020	.0030
Tool Steels & Die Steels O7, M1, M2, M3, M4, M7, T1, T2, T4, T5, T8, T15, A2, A3, A6, A7, H10, H11, H12, H13, H19, H21, L3, L6, L7, P2, P20, S1, S5, S7, 52100, A 128, D2, D3, D4, D5, D7	P	28 to 44 Rc	205		Screw Machine	150	.0010	.0020	.0030
			205T				.0010	.0020	.0030
Stainless Steel - Moderately Difficult 301, 302, 303 High Tensile, 304, 304L, 305, 420, 15-5PH, 17-4PH, 17-7PH	M	up to 28 Rc	205		Screw Machine	140	.0010	.0020	.0030
			205T				.0010	.0020	.0030
Stainless Steel - Difficult to Machine 302B, 304B, 309, 310, 316, 316B, 316L, 316Ti, 317, 317L, 321, PH13-8Mo, Nitronics	M	up to 28 Rc	205		Screw Machine	60	.0003	.0005	.0020
			205T				.0003	.0005	.0020
High Temp Alloys Nimonic, Inconel, Monel, Hastelloy	S	up to 42 Rc	205		Screw Machine	60	.0003	.0005	.0020
			205T				.0003	.0005	.0020
Titanium Alloys 6Al-4V, 5Al-2.5 Sn, 6Al-2 Sn-4Zr-6Mo, 3Al-8V-6Cr4Mo-4Zr, 10V-2Fe-3Al, 13V-11Cr-3Al	S	up to 42 Rc	205		Screw Machine	80	.0003	.0005	.0020
			205T				.0003	.0005	.0020
Cast Iron - Gray CG, ASTM A48, CLASS 20, 25, 30, 35, SAE J431C, GRADES G1800, G3000, G3500, GG 10, 15, 20, 25, 30, 35, 40	K	up to 240 HB	205		Screw Machine	175	.0010	.0020	.0030
			205T				.0010	.0020	.0030
Cast Iron - Ductile & Malleable CGI, 60-40-18, 65-45-12, D4018, D4512, D5506, 32510, 35108, M3210, M4504, M5503, 250, 300, 350, 400, 450	K	over 240 HB	205		Screw Machine	175	.0010	.0020	.0030
			205T				.0010	.0020	.0030
Plastics	N		205		Screw Machine	300	.0003	.0005	.0020
			205T				.0003	.0005	.0020
			207				3	300	.0003
Kevlar/Graphite	N		207		3	375	.0003	.0005	.0020
Hardened Steel	H	45 to 65 Rc	205		Screw Machine	50	.0003	.0010	.0010
			205T				.0003	.0010	.0010

Technical Information
MICRO Drills

Technical data provided should be considered advisory only as variations may be necessary depending on the particular application.



Recommended Cutting Data 205 / 207 - Metric

Workpiece Material Group	I S O	Hardness	Tool Series	T Y P E	D E P T H	vc - m/min	Drill Diameter (mm)		
							1	2	3
							f - mm/Rev		
Free Machining & Low Carbon Steels 1006, 1008, 1015, 1018, 1020, 1022, 1025, 1117, 1140, 1141, 11L08, 11L14, 1213, 12L13, 12L14, 1215, 1330	P	up to 28 Rc	205	●	Screw Machine	55	.025	.050	.078
			205T				.025	.050	.078
Medium Carbon & High Carbon Steels, Alloy Steels & Easy to Machine Tool Steels 1030, 1035, 1040, 1045, 1050, 1052, 1055, 1060, 1085, 1095, 1541, 1551, 9255, 2515, 3135, 3415, 4130, 4137, 4140, 4150, 4320, 4340, 4520, 5015, 5115, 5120, 5132, 5140, 5155, 6150, 8620, 9262, 9840, 52100, O1, O2, O6, S2, W1 to W310	P	28 to 38 Rc	205	●	Screw Machine	45	.025	.050	.078
			205T				.025	.050	.078
Tool Steels & Die Steels O7, M1, M2, M3, M4, M7, T1, T2, T4, T5, T8, T15, A2, A3, A6, A7, H10, H11, H12, H13, H19, H21, L3, L6, L7, P2, P20, S1, S5, S7, 52100, A 128, D2, D3, D4, D5, D7	P	28 to 44 Rc	205	●	Screw Machine	35	.025	.050	.078
			205T				.025	.050	.078
Stainless Steel - Moderately Difficult 301, 302, 303 High Tensile, 304, 304L, 305, 420, 15-5PH, 17-4PH, 17-7PH	M	up to 28 Rc	205	●	Screw Machine	45	.025	.050	.078
			205T				.025	.050	.078
Stainless Steel - Difficult to Machine 302B, 304B, 309, 310, 316, 316B, 316L, 316Ti, 317, 317L, 321, PH13-8Mo, Nitronics	M	up to 28 Rc	205	●	Screw Machine	20	.006	.013	.050
			205T				.006	.013	.050
High Temp Alloys Nimonic, Inconel, Monel, Hastelloy	S	up to 42 Rc	205	●	Screw Machine	20	.006	.013	.050
			205T				.006	.013	.050
Titanium Alloys 6Al-4V, 5Al-2.5 Sn, 6Al-2 Sn-4Zr-6Mo, 3Al-8V-6Cr4Mo-4Zr, 10V-2Fe-3Al, 13V-11Cr-3Al	S	up to 42 Rc	205	●	Screw Machine	25	.006	.013	.050
			205T				.006	.013	.050
Cast Iron - Gray CG, ASTM A48, CLASS 20, 25, 30, 35, SAE J431C, GRADES G1800, G3000, G3500, GG 10, 15, 20, 25, 30, 35, 40	K	up to 240 HB	205	●	Screw Machine	55	.025	.050	.078
			205T				.025	.050	.078
Cast Iron - Ductile & Malleable CGI 60-40-18, 65-45-12, D4018, D4512, D5506, 32510, 35108, M3210, M4504, M5503, 250, 300, 350, 400, 450	K	over 240 HB	205	●	Screw Machine	55	.025	.050	.078
			205T				.025	.050	.078
Plastics	N		205	●	Screw Machine	90	.006	.013	.050
			205T						
			207						
Kevlar/Graphite	N		207		Screw Machine	115	.006	.013	.050
Hardened Steel	H	45 to 65 Rc	205	●	Screw Machine	15	.0063	.0254	.0254
			205T				.0063	.0254	.0254

Technical data provided should be considered advisory only as variations may be necessary depending on the particular application.



Recommended Cutting Data 300 - Inch

Workpiece Material Group	I S O	Hardness	T Y P E	vc - SFM	Drill Diameter			
					1/64	1/32	1/16	1/8
					f - IPR			
Free Machining & Low Carbon Steels 1006, 1008, 1015, 1018, 1020, 1022, 1025, 1117, 1140, 1141, 11L08, 11L14, 1213, 12L13, 12L14, 1215, 1330	P	up to 28 Rc	●	175	.0007	.0010	.0020	.0030
Medium Carbon & High Carbon Steels, Alloy Steels & Easy to Machine Tool Steels 1030, 1035, 1040, 1045, 1050, 1052, 1055, 1060, 1085, 1095, 1541, 1551, 9255, 2515, 3135, 3415, 4130, 4137, 4140, 4150, 4320, 4340, 4520, 5015, 5115, 5120, 5132, 5140, 5155, 6150, 8620, 9262, 9840, 52100, O1, O2, O6, S2, W1 to W310	P	28 to 38 Rc		150	.0007	.0010	.0020	.0030
Aluminum (<10% Si) 6061-T6 / 7075-T6	N	●	●	400	.0007	.0010	.0020	.0030
Aluminum (>10% Si) Copper / Brass	N			250	.0007	.0010	.0020	.0030
Plastics	N			300	.0007	.0010	.0020	.0030
Cast Iron - Gray CG, ASTM A48, CLASS 20, 25, 30, 35, SAE J431C, GRADES G1800, G3000, G3500, GG 10, 15, 20, 25, 30, 35, 40	K	up to 240 HB	●	275	.0007	.0010	.0020	.0030
Cast Iron - Ductile & Malleable CGI 60-40-18, 65-45-12, D4018, D4512, D5506, 32510, 35108, M3210, M4504, M5503, 250, 300, 350, 400, 450	K	over 240 HB		175	.0007	.0010	.0020	.0030

Recommended Cutting Data 300 - Metric

Workpiece Material Group	I S O	Hardness	T Y P E	vc - m/min	Drill Diameter (mm)			
					0.5	1	2	3
					f - mm/Rev			
Free Machining & Low Carbon Steels 1006, 1008, 1015, 1018, 1020, 1022, 1025, 1117, 1140, 1141, 11L08, 11L14, 1213, 12L13, 12L14, 1215, 1330	P	up to 28 Rc	●	55	.017	.025	.050	.076
Medium Carbon & High Carbon Steels, Alloy Steels & Easy to Machine Tool Steels 1030, 1035, 1040, 1045, 1050, 1052, 1055, 1060, 1085, 1095, 1541, 1551, 9255, 2515, 3135, 3415, 4130, 4137, 4140, 4150, 4320, 4340, 4520, 5015, 5115, 5120, 5132, 5140, 5155, 6150, 8620, 9262, 9840, 52100, O1, O2, O6, S2, W1 to W310	P	28 to 38 Rc		45	.017	.025	.050	.076
Aluminum (<10% Si) 6061-T6 / 7075-T6	N	●	●	120	.017	.025	.050	.076
Aluminum (>10% Si) Copper / Brass	N			75	.017	.025	.050	.076
Plastics	N			90	.017	.025	.050	.076
Cast Iron - Gray CG, ASTM A48, CLASS 20, 25, 30, 35, SAE J431C, GRADES G1800, G3000, G3500, GG 10, 15, 20, 25, 30, 35, 40	K	up to 240 HB	●	85	.017	.025	.050	.076
Cast Iron - Ductile & Malleable CGI 60-40-18, 65-45-12, D4018, 4512, D5506, 32510, 35108, M3210, M4504, M5503, 250, 300, 350, 400, 450	K	over 240 HB		55	.017	.025	.050	.076

Technical data provided should be considered advisory only as variations may be necessary depending on the particular application.



Recommended Cutting Data 302 - Inch

Workpiece Material Group	I S O	Hardness	T Y P E	vc - SFM	Drill Diameter				
					1/64	1/32	1/16	3/32	1/8
					f - IPR				
Free Machining & Low Carbon Steels 1006, 1008, 1015, 1018, 1020, 1022, 1025, 1117, 1140, 1141, 11L08, 11L14, 1213, 12L13, 12L14, 1215, 1330	P	up to 28 Rc		300	.0003	.0006	.0012	.0018	.0023
Medium Carbon & High Carbon Steels, Alloy Steels & Easy to Machine Tool Steels 1030, 1035, 1040, 1045, 1050, 1052, 1055, 1060, 1085, 1095, 1541, 1551, 9255, 2515, 3135, 3415, 4130, 4137,4140, 4150, 4320, 4340, 4520, 5015, 5115, 5120, 5132, 5140, 5155, 6150, 8620, 9262, 9840, 52100, O1, O2, O6, S2, W1 to W310	P	28 to 38 Rc	●	225	.0003	.0006	.0012	.0018	.0023
Tool Steels & Die Steels O7, M1, M2, M3, M4, M7, T1, T2, T4, T5, T8, T15, A2, A3, A6, A7, H10, H11, H12, H13, H19, H21, L3, L6, L7, P2, P20, S1, S5, S7, 52100, A 128, D2, D3, D4, D5, D7	P	28 to 44 Rc		200	.0003	.0006	.0012	.0018	.0023
Hardened Steels A2 / 52100	H	35-45 Rc	●	50	.0001	.0003	.0005	.0008	.001
Free Machining Stainless	M	up to 28 Rc		175	.0003	.0006	.0012	.0018	.0023
Stainless Steel - Austenitic 304 / 316	M	up to 28 Rc	●	200	.0003	.0006	.0012	.0018	.0023
Stainless Steel - Ferritic / Martensitic	M	up to 28 Rc		100	.0003	.0006	.0012	.0018	.0023
Stainless Steel - Moderately Difficult 301, 302, 303 High Tensile, 304, 304L, 305, 420, 15-5PH, 17-4PH, 17-7PH	M	over 28 Rc		75	.0003	.0006	.0012	.0018	.0023
Aluminum (<10% Si)	N			450	.0006	.0012	.002	.003	.004
Aluminum (>10% Si)	N		●	325	.0006	.0012	.002	.003	.004
Plastics	N			550	.0006	.0012	.002	.003	.004
Composites / Fiber Reinforced Materials / Circuit Boards	N			650	.001-.0015	.002	.003	.004	.005
Cast Iron - Gray CG, ASTM A48, CLASS 20, 25, 30, 35, SAE J431C, GRADES G1800, G3000, G3500, GG 10, 15, 20, 25, 30, 35, 40	K	up to 240 HB		●	400	.0003	.0006	.0012	.0018
Cast Iron - Ductile & Malleable CGI 60-40-18, 65-45-12, D4018, D4512, D5506, 32510, 35108, M3210, M4504, M5503, 250, 300, 350, 400, 450	K	over 240 HB	350		.0003	.0006	.0012	.0018	.0023
Titanium 6Al-4V	S	up to 42 Rc	●	60	.0003	.0006	.0012	.0018	.0023
High Temp Alloys Inconel / Hastelloy / Waspeloy / Nickel Based Alloys-Monel	S	up to 42 Rc		50	.0001	.0003	.0005	.0008	.001

Chiploads above .006 are not recommended since location problems become more evident.

In typical circuit board materials, Micro Drills operate efficiently in the 600-700 SFM (180-215 m/min) ranges. Higher speed rates tend to produce excessive drill wear and early failure. In general, smaller diameter drills are limited to slower speeds, because of machine limitations.

Feed rates can be set extremely high in most applications, because of the quality and design features of the M.A. Ford® Micro Drill. However, certain precautions should be taken for proper performance and safety. When determining optimum feed rates, consider the following factors:

- Spindle motors must be rated at least one hp (1 horsepower).
- To prevent delamination, entry materials must be used.
- Pressure foot clamping must be appropriate.

When drilling harder materials, the Micro Drill life may be variable. Drilling set ups must be precise. The drill TIR must be less than .0001" (.0025mm). The feed axis motion must be smooth without any play. Machining practices are very important.

Note: Micro drills should be kept in their original packaging, or equivalent when not in use. Mechanical micrometers are not recommended for checking size.

Technical data provided should be considered advisory only as variations may be necessary depending on the particular application.



Recommended Cutting Data 302 - Metric

Workpiece Material Group	ISO	Hardness	TYPE	vc - m/min	Drill Diameter (mm)				
					0.5	1	2	2.5	3
					f - mm/Rev				
Free Machining & Low Carbon Steels 1006, 1008, 1015, 1018, 1020, 1022, 1025, 1117, 1140, 1141, 11L08, 11L14, 1213, 12L13, 12L14, 1215, 1330	P	up to 28 Rc		90	.0075	.0150	.0300	.0450	.0560
Medium Carbon & High Carbon Steels, Alloy Steels & Easy to Machine Tool Steels 1030, 1035, 1040, 1045, 1050, 1052, 1055, 1060, 1085, 1095, 1541, 1551, 9255, 2515, 3135, 3415, 4130, 4137, 4140, 4150, 4320, 4340, 4520, 5015, 5115, 5120, 5132, 5140, 5155, 6150, 8620, 9262, 9840, 52100, O1, O2, O6, S2, W1 to W310	P	28 to 38 Rc	●	70	.0075	.0150	.0300	.0450	.0560
Tool Steels & Die Steels O7, M1, M2, M3, M4, M7, T1, T2, T4, T5, T8, T15, A2, A3, A6, A7, H10, H11, H12, H13, H19, H21, L3, L6, L7, P2, P20, S1, S5, S7, 52100, A 128, D2, D3, D4, D5, D7	P	28 to 44 Rc		60	.0075	.0150	.0300	.0450	.0560
Hardened Steels A2 / 52100	H	35-45 Rc	●	15	.0035	.0075	.0150	.0190	.0260
Free Machining Stainless	M	up to 28 Rc		55	.0075	.0150	.0300	.0450	.0560
Stainless Steel - Austenitic 304 / 316	M	up to 28 Rc		60	.0075	.0150	.0300	.0450	.0560
Stainless Steel - Ferritic / Martensitic	M	up to 28 Rc	●	30	.0075	.0150	.0300	.0450	.0560
Stainless Steel - Moderately Difficult 301, 302, 303 High Tensile, 304, 304L, 305, 420, 15-5PH, 17-4PH, 17-7PH	M	over 28 Rc		25	.0075	.0150	.0300	.0450	.0560
Aluminum (<10% Si)	N			140	.015	.0300	.0600	.0800	.1000
Aluminum (>10% Si)	N		●	100	.015	.0300	.0600	.0800	.1000
Plastics	N			170	.015	.0300	.0600	.0800	.1000
Composites / Fiber Reinforced Materials / Circuit Boards	N			200	.025- .038	.0510	.0760	.1020	.1270
Cast Iron - Gray CG, ASTM A48, CLASS 20, 25, 30, 35, SAE J431C, GRADES G1800, G3000, G3500, GG 10, 15, 20, 25, 30, 35, 40	K	up to 240 HB	●	120	.0075	.0150	.0300	.0450	.0560
Cast Iron - Ductile & Malleable CGI 60-40-18, 65-45-12, D4018, D4512, D5506, 32510, 35108, M3210, M4504, M5503, 250, 300, 350, 400, 450	K	over 240 HB		110	.0075	.0150	.0300	.0450	.0560
Titanium 6Al-4V	S	up to 42 Rc		20	.0075	.0150	.0300	.0450	.0560
High Temp Alloys Inconel / Hastelloy / Waspeloy / Nickel Based Alloys-Monel	S	up to 42 Rc	●	15	.0025	.0075	.0120	.0200	.0250

Chiploads above .140 are not recommended since location problems become more evident.

In typical circuit board materials, Micro Drills operate efficiently in the 600-700 SFM (180-215 m/min) ranges. Higher speed rates tend to produce excessive drill wear and early failure. In general, smaller diameter drills are limited to slower speeds, because of machine limitations.

Feed rates can be set extremely high in most applications, because of the quality and design features of the M.A. Ford® Micro Drill. However, certain precautions should be taken for proper performance and safety. When determining optimum feed rates, consider the following factors:

- Spindle motors must be rated at least one hp (1 horsepower).
- To prevent delamination, entry materials must be used.
- Pressure foot clamping must be appropriate.

When drilling harder materials, the Micro Drill life may be variable. Drilling set ups must be precise. The drill TIR must be less than .0001" (.0025mm). The feed axis motion must be smooth without any play. Machining practices are very important.

Note: Micro drills should be kept in their original packaging, or equivalent when not in use. Mechanical micrometers are not recommended for checking size.

Technical data provided should be considered advisory only as variations may be necessary depending on the particular application.



Recommended Cutting Data 402 / 405 - Inch

Workpiece Material Group	I S O	Hardness	Tool Series	T Y P E	vc - SFM	Drill Diameter		
						1/32	1/16	1/8
						f - IPR		
Free Machining & Low Carbon Steels 1006, 1008, 1015, 1018, 1020, 1022, 1025, 1117, 1140, 1141, 11L08, 11L14, 1213, 12L13, 12L14, 1215, 1330	P	up to 28 Rc	402	●	175	.0005	.0010	.0015
			405					
Medium Carbon & High Carbon Steels, Alloy Steels & Easy to Machine Tool Steels 1030, 1035, 1040, 1045, 1050, 1052, 1055, 1060, 1085, 1095, 1541, 1551, 9255, 2515, 3135, 3415, 4130, 4137, 4140, 4150, 4320, 4340, 4520, 5015, 5115, 5120, 5132, 5140, 5155, 6150, 8620, 9262, 9840, 52100, O1, O2, O6, S2, W1 to W310	P	28 to 38 Rc	402	●	165	.0005	.0010	.0015
			405					
Tool Steels & Die Steels O7, M1, M2, M3, M4, M7, T1, T2, T4, T5, T8, T15, A2, A3, A6, A7, H10, H11, H12, H13, H19, H21, L3, L6, L7, P2, P20, S1, S5, S7, 52100, A 128, D2, D3, D4, D5, D7	P	28 to 44 Rc	402	●	150	.0005	.0010	.0015
			405					
Hardened Steels A2 / 52100	H	35 to 45 Rc	402	●	50	.0005	.0010	.0015
			405					
Stainless Steel - Austenitic 304 / 316	M	up to 28 Rc	402	●	125	.0005	.0010	.0015
			405					
Stainless Steel - Moderately Difficult 301, 302, 303 High Tensile, 304, 304L, 305, 420, 15-5PH, 17-4PH, 17-7PH	M	over 28 Rc	402	●	60	.0005	.0010	.0015
			405					
Cast Iron - Gray CG, ASTM A48, CLASS 20, 25, 30, 35, SAE J431C, GRADES G1800, G3000, G3500, GG 10, 15, 20, 25, 30, 35, 40	K	up to 240 HB	402	●	275	.0005	.0010	.0015
			405					
Cast Iron - Ductile & Malleable CGI 60-40-18, 65-45-12, D4018, D4512, D5506, 32510, 35108, M3210, M4504, M5503, 250, 300, 350, 400, 450	K	over 240 HB	402	●	175	.0005	.0010	.0015
			405					
Titanium 6Al-4V	S	up to 42 Rc	402	●	80	.0005	.0010	.0015
			405					
High Temp Alloys Inconel / Hastelloy / Waspeloy / Nickel Based Alloys-Monel	S	up to 42 Rc	402	●	40	.0005	.0010	.0015
			405					

Technical data provided should be considered advisory only as variations may be necessary depending on the particular application.





Recommended Cutting Data 402 / 405 - Metric

Workpiece Material Group	I S O	Hardness	Tool Series	T Y P E	vc - m/min	Drill Diameter (mm)		
						1	2	3
						f - mm/Rev		
Free Machining & Low Carbon Steels 1006, 1008, 1015, 1018, 1020, 1022, 1025, 1117, 1140, 1141, 11L08, 11L14, 1213, 12L13, 12L14, 1215, 1330	P	up to 28 Rc	402		55	.013	.025	.038
			405					
Medium Carbon & High Carbon Steels, Alloy Steels & Easy to Machine Tool Steels 1030, 1035, 1040, 1045, 1050, 1052, 1055, 1060, 1085, 1095, 1541, 1551, 9255, 2515, 3135, 3415, 4130, 4137, 4140, 4150, 4320, 4340, 4520, 5015, 5115, 5120, 5132, 5140, 5155, 6150, 8620, 9262, 9840, 52100, O1, O2, O6, S2, W1 to W310	P	28 to 38 Rc	402	●	50	.013	.025	.038
			405					
Tool Steels & Die Steels O7, M1, M2, M3, M4, M7, T1, T2, T4, T5, T8, T15, A2, A3, A6, A7, H10, H11, H12, H13, H19, H21, L3, L6, L7, P2, P20, S1, S5, S7, 52100, A 12B, D2, D3, D4, D5, D7	P	28 to 44 Rc	402		45	.013	.025	.038
			405					
Hardened Steels A2 / 52100	H	35 to 45 Rc	402	●	15	.013	.025	.038
			405					
Stainless Steel - Austenitic 304 / 316	M	up to 28 Rc	402	●	40	.013	.025	.038
			405					
Stainless Steel - Moderately Difficult 301, 302, 303 High Tensile, 304, 304L, 305, 420, 15-5PH, 17-4PH, 17-7PH	M	over 28 Rc	402	●	20	.013	.025	.038
			405					
Cast Iron - Gray CG, ASTM A48, CLASS 20, 25, 30, 35, SAE J431C, GRADES G1800, G3000, G3500, GG 10, 15, 20, 25, 30, 35, 40	K	up to 240 HB	402	●	85	.013	.025	.038
			405					
Cast Iron - Ductile & Malleable CGI 60-40-18, 65-45-12, D4018, D4512, D5506, 32510, 35108, M3210, M4504, M5503, 250, 300, 350, 400, 450	K	over 240 HB	402	●	55	.013	.025	.038
			405					
Titanium 6Al-4V	S	up to 42 Rc	402	●	25	.013	.025	.038
			405					
High Temp Alloys Inconel / Hastelloy / Waspeloy / Nickel Based Alloys-Monel	S	up to 42 Rc	402	●	10	.013	.025	.038
			405					

Technical data provided should be considered advisory only as variations may be necessary depending on the particular application.



Drill Terminology

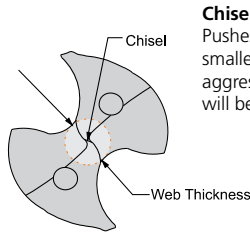
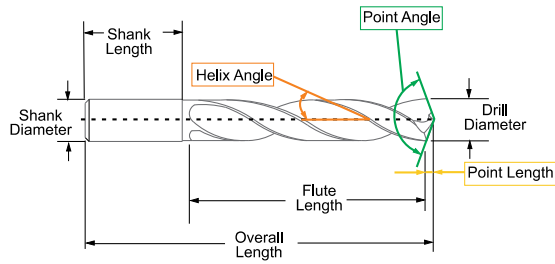

Chisel Edge – The non-cutting tip of the drill. Pushes, rather than cuts material. Having a smaller chisel means that a tool will cut more aggressively. A larger chisel means that a tool will be stronger.

Web – The core of the drill that is left from the fluting operation. A thicker web means added rigidity, while a smaller web means more chip evacuation. On two flute drills, typically varies from 16% - 30% of the tool diameter.

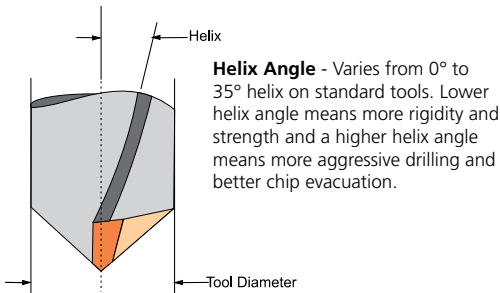

Helix Angle - Varies from 0° to 35° helix on standard tools. Lower helix angle means more rigidity and strength and a higher helix angle means more aggressive drilling and better chip evacuation.

Margin Width – Provides a surface to support the drill inside the hole during the drilling operation. M.A. Ford® offers both single margin and double margin geometries. Margin widths are a balancing act between friction build-up vs. tool support in the drilling operation.

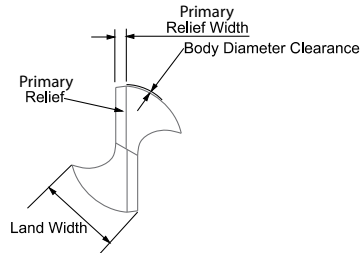

Cutting Lip - The cutting edges of a two flute drill extending from the chisel edge to the periphery.

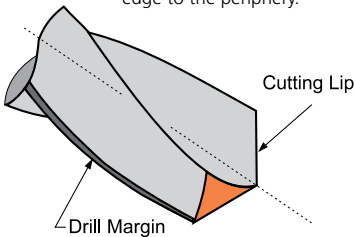

Land Width – The amount of material left on the drill per side, from the fluting operation. Larger land widths mean more rigidity, while smaller land widths allow for better chip evacuation.

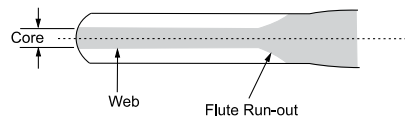

Having a problem with drill geometries? Circle the area where the problem exists. Include a detailed explanation of the issue and email to sales@maford.com, Attn: Technical Application Support.

Technical data provided should be considered advisory only as variations may be necessary depending on the particular application.

TuffCut® End Mills

High Performance End Mills

M.A.Ford® TuffCut® End Mills perform better and last significantly longer than competitive products, minimizing process downtime and maximizing productivity and cost efficiency. Included in our product line are high performance end mills developed for specific applications such as stainless steels and high temperature alloys, hardened steel, titanium, composite material, aluminum and softer alloys.

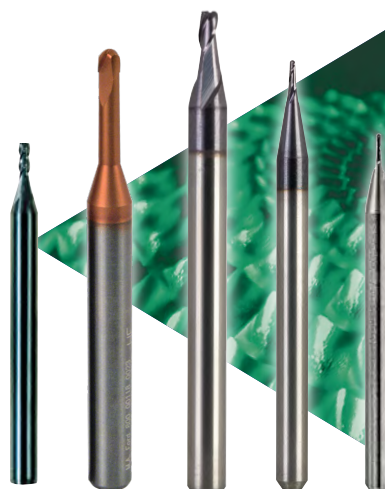

	Page
TuffCut® Series 3MVS	68
TuffCut® Series 3MVR	72
TuffCut DM® Series 156	74
TuffCut DM® Series 158	77
TuffCut® GP Series 111	79
TuffCut® GP Series 111 Coated	81
TuffCut® GP Series 163	82
TuffCut® GP Series 116	84

	Page
TuffCut® GP Series 116 Coated	85
TuffCut® GP Series 169	87
TuffCut® GP Series 169 Coated	88
TuffCut® GP Series 121	90
TuffCut® GP Series 121 Coated	92
TuffCut® GP Series 164	93
TuffCut® GP Series 140	96

	Page
TuffCut® GP Series 140 Coated	97
TuffCut® GP Series 165	98
TuffCut® GP Series 150	99
TuffCut® GP Series 150 Coated	101
TuffCut® GP Series 166	102
Technical Information	104-136

Series 3MVS



Designed for high performance micro milling in stainless steels and exotic alloys used in medical and aerospace manufacturing.

- Variable helix
- Stub length
- Square end and corner radius options
- Neck relief options
- ALtima® 52 coated
- Common shanks

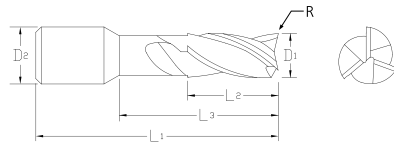

Series 3MVS

TuffCut®

MICRO End Mills

3 Flute

ALtima® 52		Diameter			Shank		OAL		Flute Length		Neck Length		Corner Radius	
		D1			D2		L1		L2		L3		R	
Tool No.	EDP	Fraction	mm	Decimal	Inch	mm	Inch	mm	Inch	mm	Inch	mm	Inch	mm
3MVS0156AH	39000	1/64	-	.0156	1/8	-	1-1/2	-	0.023	-	-	-	-	-
3MVS0156N5AH	39002	1/64	-	.0156	1/8	-	2-1/2	-	0.023	-	0.078	-	-	-
3MVS0156N8AH	39003	1/64	-	.0156	1/8	-	2-1/2	-	0.023	-	0.125	-	-	-
3MVS0156R.003AH	39066	1/64	-	.0156	1/8	-	1-1/2	-	0.023	-	-	-	.003	-
3MVS0156R.003N5AH	39068	1/64	-	.0156	1/8	-	2-1/2	-	0.023	-	0.078	-	.003	-
3MVS0156R.003N8AH	39069	1/64	-	.0156	1/8	-	2-1/2	-	0.023	-	0.125	-	.003	-
3MVS0050AH	39004	-	0.50	.0196	-	4	-	50	-	0.75	-	-	-	-
3MVS0050R.10AH	39070	-	0.50	.0196	-	4	-	50	-	0.75	-	-	-	.10
3MVS0050R.10N5AH	39072	-	0.50	.0196	-	4	-	50	-	0.75	-	2.5	-	.10
3MVS0050R.10N8AH	39073	-	0.50	.0196	-	4	-	50	-	0.75	-	4.0	-	.10
3MVS0312AH	39006	1/32	-	.0312	1/8	-	1-1/2	-	0.047	-	-	-	-	-
3MVS0312N10AH	39011	1/32	-	.0312	1/8	-	2-1/2	-	0.047	-	0.312	-	-	-
3MVS0312N12AH	39012	1/32	-	.0312	1/8	-	2-1/2	-	0.047	-	0.375	-	-	-
3MVS0312N15AH	39013	1/32	-	.0312	1/8	-	2-1/2	-	0.047	-	0.480	-	-	-
3MVS0312N3AH	39008	1/32	-	.0312	1/8	-	1-1/2	-	0.047	-	0.093	-	-	-
3MVS0312N5AH	39009	1/32	-	.0312	1/8	-	2-1/2	-	0.047	-	0.156	-	-	-
3MVS0312N8AH	39010	1/32	-	.0312	1/8	-	2-1/2	-	0.047	-	0.250	-	-	-
3MVS0312R.005AH	39074	1/32	-	.0312	1/8	-	1-1/2	-	0.047	-	-	-	.005	-
3MVS0312R.005N5AH	39076	1/32	-	.0312	1/8	-	2-1/2	-	0.047	-	0.156	-	.005	-
3MVS0312R.005N8AH	39077	1/32	-	.0312	1/8	-	2-1/2	-	0.047	-	0.250	-	.005	-
3MVS0312R.010AH	39078	1/32	-	.0312	1/8	-	1-1/2	-	0.047	-	-	-	.010	-
3MVS0312R.010N5AH	39080	1/32	-	.0312	1/8	-	2-1/2	-	0.047	-	0.156	-	.010	-
3MVS0312R.010N8AH	39081	1/32	-	.0312	1/8	-	2-1/2	-	0.047	-	0.250	-	.010	-
3MVS0100AH	39014	-	1.00	.0394	-	4	-	50	-	1.50	-	-	-	-
3MVS0100N5AH	39016	-	1.00	.0394	-	4	-	50	-	1.50	-	5	-	-
3MVS0100N8AH	39017	-	1.00	.0394	-	4	-	50	-	1.50	-	8	-	-
3MVS0100R.10AH	39082	-	1.00	.0394	-	4	-	50	-	1.50	-	-	-	.10
3MVS0100R.10N5AH	39084	-	1.00	.0394	-	4	-	50	-	1.50	-	5	-	.10

Inch	
D1	Tolerance
.0156 - .1250	+0/--.0008

Inch	
D2	Tolerance (h6)
.1250	+0/--.00031

Metric (mm)	
D1	Tolerance
0.5 - 3.0	+0/--.020

Metric (mm)	
D2	Tolerance (h6)
4.0	+0/--.008



Page 113



Series 3MVS Continued

Altima® 52		Diameter			Shank		OAL		Flute Length		Neck Length		Corner Radius	
Tool No.	EDP	D1			D2		L1		L2		L3		R	
		Fraction	mm	Decimal	Inch	mm	Inch	mm	Inch	mm	Inch	mm	Inch	mm
3MVS0100R.10N8AH	39085	-	1.00	.0394	-	4	-	50	-	1.50	-	8	-	.10
3MVS0468AH	39018	3/64	-	.0468	1/8	-	1-1/2	-	0.070	-	-	-	-	-
3MVS0468N10AH	39022	3/64	-	.0468	1/8	-	2-1/2	-	0.070	-	0.480	-	-	-
3MVS0468N5AH	39020	3/64	-	.0468	1/8	-	2-1/2	-	0.070	-	0.250	-	-	-
3MVS0468N8AH	39021	3/64	-	.0468	1/8	-	2-1/2	-	0.070	-	0.375	-	-	-
3MVS0468R.005AH	39086	3/64	-	.0468	1/8	-	1-1/2	-	0.070	-	-	-	.005	-
3MVS0468R.005N5AH	39088	3/64	-	.0468	1/8	-	2-1/2	-	0.070	-	0.250	-	.005	-
3MVS0468R.005N8AH	39089	3/64	-	.0468	1/8	-	2-1/2	-	0.070	-	0.375	-	.005	-
3MVS0468R.010AH	39090	3/64	-	.0468	1/8	-	1-1/2	-	0.070	-	-	-	.010	-
3MVS0468R.010N5AH	39092	3/64	-	.0468	1/8	-	2-1/2	-	0.070	-	0.250	-	.010	-
3MVS0468R.010N8AH	39093	3/64	-	.0468	1/8	-	2-1/2	-	0.070	-	0.375	-	.010	-
3MVS0150AH	39023	-	1.50	.0591	-	4	-	50	-	2.25	-	-	-	-
3MVS0150R.20AH	39094	-	1.50	.0591	-	4	-	50	-	2.25	-	-	-	.20
3MVS0150R.20N5AH	39096	-	1.50	.0591	-	4	-	50	-	2.25	-	7.5	-	.20
3MVS0150R.20N8AH	39097	-	1.50	.0591	-	4	-	50	-	2.25	-	12	-	.20
3MVS0150R.50AH	39162	-	1.50	.0591	-	4	-	50	-	2.25	-	-	-	.50
3MVS0150R.50N6AH	39163	-	1.50	.0591	-	4	-	50	-	2.25	-	10	-	.50
3MVS0150R.50N8AH	39164	-	1.50	.0591	-	4	-	50	-	2.25	-	12	-	.50
3MVS0625AH	39025	1/16	-	.0625	1/8	-	1-1/2	-	0.094	-	-	-	-	-
3MVS0625N10AH	39030	1/16	-	.0625	1/8	-	2-1/2	-	0.094	-	0.625	-	-	-
3MVS0625N12AH	39031	1/16	-	.0625	1/8	-	2-1/2	-	0.094	-	0.750	-	-	-
3MVS0625N15AH	39032	1/16	-	.0625	1/8	-	2-1/2	-	0.094	-	0.950	-	-	-
3MVS0625N3AH	39027	1/16	-	.0625	1/8	-	1-1/2	-	0.094	-	0.187	-	-	-
3MVS0625N5AH	39028	1/16	-	.0625	1/8	-	2-1/2	-	0.094	-	0.312	-	-	-
3MVS0625N8AH	39029	1/16	-	.0625	1/8	-	2-1/2	-	0.094	-	0.500	-	-	-
3MVS0625R.005AH	39098	1/16	-	.0625	1/8	-	1-1/2	-	0.094	-	-	-	.005	-
3MVS0625R.005N5AH	39100	1/16	-	.0625	1/8	-	2-1/2	-	0.094	-	0.312	-	.005	-
3MVS0625R.005N8AH	39101	1/16	-	.0625	1/8	-	2-1/2	-	0.094	-	0.500	-	.005	-
3MVS0625R.010AH	39102	1/16	-	.0625	1/8	-	1-1/2	-	0.094	-	-	-	.010	-
3MVS0625R.010N5AH	39104	1/16	-	.0625	1/8	-	2-1/2	-	0.094	-	0.312	-	.010	-
3MVS0625R.010N8AH	39105	1/16	-	.0625	1/8	-	2-1/2	-	0.094	-	0.500	-	.010	-
3MVS0625R.015AH	39106	1/16	-	.0625	1/8	-	1-1/2	-	0.094	-	-	-	.015	-
3MVS0625R.015N5AH	39108	1/16	-	.0625	1/8	-	2-1/2	-	0.094	-	0.312	-	.015	-
3MVS0625R.015N8AH	39109	1/16	-	.0625	1/8	-	2-1/2	-	0.094	-	0.500	-	.015	-
3MVS0781AH	39033	5/64	-	.0781	1/8	-	1-1/2	-	0.117	-	-	-	-	-
3MVS0781N10AH	39037	5/64	-	.0781	1/8	-	2-1/2	-	0.117	-	0.800	-	-	-
3MVS0781N5AH	39035	5/64	-	.0781	1/8	-	2-1/2	-	0.117	-	0.406	-	-	-
3MVS0781N8AH	39036	5/64	-	.0781	1/8	-	2-1/2	-	0.117	-	0.625	-	-	-
3MVS0781R.005AH	39110	5/64	-	.0781	1/8	-	1-1/2	-	0.117	-	-	-	.005	-
3MVS0781R.005N5AH	39112	5/64	-	.0781	1/8	-	2-1/2	-	0.117	-	0.406	-	.005	-
3MVS0781R.005N8AH	39113	5/64	-	.0781	1/8	-	2-1/2	-	0.117	-	0.625	-	.005	-
3MVS0781R.010AH	39114	5/64	-	.0781	1/8	-	1-1/2	-	0.117	-	-	-	.010	-
3MVS0781R.010N5AH	39116	5/64	-	.0781	1/8	-	2-1/2	-	0.117	-	0.406	-	.010	-
3MVS0781R.010N8AH	39117	5/64	-	.0781	1/8	-	2-1/2	-	0.117	-	0.625	-	.010	-
3MVS0781R.015AH	39118	5/64	-	.0781	1/8	-	1-1/2	-	0.117	-	-	-	.015	-
3MVS0781R.015N5AH	39120	5/64	-	.0781	1/8	-	2-1/2	-	0.117	-	0.406	-	.015	-

Series 3MVS

TuffCut®

MICRO End Mills





Series 3MVS Continued

Altima® 52		Diameter			Shank		OAL		Flute Length		Neck Length		Corner Radius	
Tool No.	EDP	D1			D2		L1		L2		L3		R	
		Fraction	mm	Decimal	Inch	mm	Inch	mm	Inch	mm	Inch	mm	Inch	mm
3MVS0781R.015N8AH	39121	5/64	-	.0781	1/8	-	2-1/2	-	0.117	-	0.625	-	.015	-
3MVS0200AH	39038	-	2.00	.0787	-	4	-	50	-	3.00	-	-	-	-
3MVS0200N5AH	39040	-	2.00	.0787	-	4	-	50	-	3.00	-	10	-	-
3MVS0200N8AH	39041	-	2.00	.0787	-	4	-	50	-	3.00	-	16	-	-
3MVS0200R.20AH	39122	-	2.00	.0787	-	4	-	50	-	3.00	-	-	-	.20
3MVS0200R.20N5AH	39124	-	2.00	.0787	-	4	-	50	-	3.00	-	10	-	.20
3MVS0200R.20N8AH	39125	-	2.00	.0787	-	4	-	50	-	3.00	-	16	-	.20
3MVS0938AH	39042	3/32	-	.0938	1/8	-	1-1/2	-	.141	-	-	-	-	-
3MVS0938N10AH	39047	3/32	-	.0938	1/8	-	2-1/2	-	.141	-	0.950	-	-	-
3MVS0938N12AH	39048	3/32	-	.0938	1/8	-	2-1/2	-	.141	-	1.125	-	-	-
3MVS0938N15AH	39049	3/32	-	.0938	1/8	-	2-1/2	-	.141	-	1.400	-	-	-
3MVS0938N3AH	39044	3/32	-	.0938	1/8	-	1-1/2	-	.141	-	0.279	-	-	-
3MVS0938N5AH	39045	3/32	-	.0938	1/8	-	2-1/2	-	.141	-	0.500	-	-	-
3MVS0938N8AH	39046	3/32	-	.0938	1/8	-	2-1/2	-	.141	-	0.750	-	-	-
3MVS0938R.005AH	39126	3/32	-	.0938	1/8	-	1-1/2	-	.141	-	-	-	.005	-
3MVS0938R.005N5AH	39128	3/32	-	.0938	1/8	-	2-1/2	-	.141	-	0.500	-	.005	-
3MVS0938R.005N8AH	39129	3/32	-	.0938	1/8	-	2-1/2	-	.141	-	0.750	-	.005	-
3MVS0938R.010AH	39130	3/32	-	.0938	1/8	-	1-1/2	-	.141	-	-	-	.010	-
3MVS0938R.010N5AH	39132	3/32	-	.0938	1/8	-	2-1/2	-	.141	-	0.500	-	.010	-
3MVS0938R.010N8AH	39133	3/32	-	.0938	1/8	-	2-1/2	-	.141	-	0.750	-	.010	-
3MVS0938R.015AH	39134	3/32	-	.0938	1/8	-	1-1/2	-	.141	-	-	-	.015	-
3MVS0938R.015N5AH	39136	3/32	-	.0938	1/8	-	2-1/2	-	.141	-	0.500	-	.015	-
3MVS0938R.015N8AH	39137	3/32	-	.0938	1/8	-	2-1/2	-	.141	-	0.750	-	.015	-
3MVS0938R.020AH	39138	3/32	-	.0938	1/8	-	1-1/2	-	.141	-	-	-	.020	-
3MVS0938R.020N5AH	39140	3/32	-	.0938	1/8	-	2-1/2	-	.141	-	0.500	-	.020	-
3MVS0938R.020N8AH	39141	3/32	-	.0938	1/8	-	2-1/2	-	.141	-	0.750	-	.020	-
3MVS0250AH	39050	-	2.50	.0984	-	4	-	50	-	3.75	-	-	-	-
3MVS1094AH	39052	7/64	-	.1094	1/8	-	1-1/2	-	0.164	-	-	-	-	-
3MVS1094N5AH	39054	7/64	-	.1094	1/8	-	2-1/2	-	0.164	-	0.570	-	-	-
3MVS1094N8AH	39055	7/64	-	.1094	1/8	-	2-1/2	-	0.164	-	0.900	-	-	-
3MVS0300AH	39056	-	3.00	.1181	-	4	-	50	-	4.50	-	-	-	-
3MVS0300N5AH	39058	-	3.00	.1181	-	4	-	50	-	4.50	-	15	-	-
3MVS0300N8AH	39059	-	3.00	.1181	-	4	-	50	-	4.50	-	24	-	-
3MVS0300R.20AH	39142	-	3.00	.1181	-	4	-	50	-	4.50	-	-	-	.20
3MVS0300R.20N5AH	39144	-	3.00	.1181	-	4	-	50	-	4.50	-	15	-	.20
3MVS0300R.20N8AH	39145	-	3.00	.1181	-	4	-	50	-	4.50	-	24	-	.20
3MVS1250AH	39060	1/8	-	.1250	1/8	-	1-1/2	-	0.188	-	-	-	-	-
3MVS1250N10AH	39065	1/8	-	.1250	1/8	-	2-1/2	-	0.188	-	1.250	-	-	-
3MVS1250N3AH	39062	1/8	-	.1250	1/8	-	1-1/2	-	0.188	-	0.375	-	-	-
3MVS1250N5AH	39063	1/8	-	.1250	1/8	-	2-1/2	-	0.188	-	0.625	-	-	-
3MVS1250N8AH	39064	1/8	-	.1250	1/8	-	2-1/2	-	0.188	-	1.000	-	-	-
3MVS1250R.005AH	39146	1/8	-	.1250	1/8	-	1-1/2	-	0.188	-	-	-	.005	-
3MVS1250R.005N5AH	39148	1/8	-	.1250	1/8	-	2-1/2	-	0.188	-	0.625	-	.005	-
3MVS1250R.005N8AH	39149	1/8	-	.1250	1/8	-	2-1/2	-	0.188	-	1.000	-	.005	-
3MVS1250R.010AH	39150	1/8	-	.1250	1/8	-	1-1/2	-	0.188	-	-	-	.010	-
3MVS1250R.010N5AH	39152	1/8	-	.1250	1/8	-	2-1/2	-	0.188	-	0.625	-	.010	-
3MVS1250R.010N8AH	39153	1/8	-	.1250	1/8	-	2-1/2	-	0.188	-	1.000	-	.010	-

Series 3MVS

TuffCut®

3 Flute

MICRO End Mills





Series 3MVS Continued

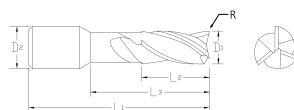

ALtima® 52		Diameter			Shank		OAL		Flute Length		Neck Length		Corner Radius	
		D1			D2		L1		L2		L3		R	
Tool No.	EDP	Fraction	mm	Decimal	Inch	mm	Inch	mm	Inch	mm	Inch	mm	Inch	mm
3MVS1250R.015AH	39154	1/8	-	.1250	1/8	-	1-1/2	-	0.188	-	-	-	.015	-
3MVS1250R.015N5AH	39156	1/8	-	.1250	1/8	-	2-1/2	-	0.188	-	0.625	-	.015	-
3MVS1250R.015N8AH	39157	1/8	-	.1250	1/8	-	2-1/2	-	0.188	-	1.000	-	.015	-
3MVS1250R.020AH	39158	1/8	-	.1250	1/8	-	1-1/2	-	0.188	-	-	-	.020	-
3MVS1250R.020N5AH	39160	1/8	-	.1250	1/8	-	2-1/2	-	0.188	-	0.625	-	.020	-
3MVS1250R.020N8AH	39161	1/8	-	.1250	1/8	-	2-1/2	-	0.188	-	1.000	-	.020	-



Page 113

Series 3MVS

TuffCut®

3
Flute

MICRO End Mills

Series 3MVR

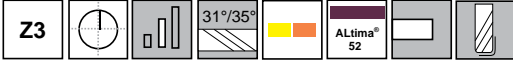

Designed for high performance micro milling in stainless steels and exotic alloys used in medical and aerospace manufacturing.

- Variable helix
- Standard length
- Square end and corner radius options
- ALtima® 52 coated
- Common shanks

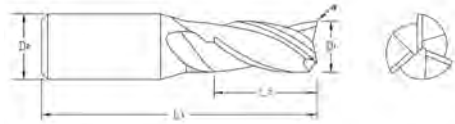

Series 3MVR

TuffCut®

MICRO End Mills

3 Flute

ALtima® 52		Diameter			Shank Diameter		OAL		Flute Length		Corner Radius	
		D1			D2		L1		L2		R	
Tool Number	EDP	Fraction	mm	Decimal	Inch	mm	Inch	mm	Inch	mm	Inch	mm
3MVR0156AH	39001	1/64	-	.0156	1/8	-	1-1/2	-	0.047	-	-	-
3MVR0156R.003AH	39067	1/64	-	.0156	1/8	-	1-1/2	-	0.047	-	.003	-
3MVRM0050AH	39005	-	0.50	.0196	-	4	-	50	-	1.50	-	-
3MVRM0050R.10AH	39071	-	0.50	.0196	-	4	-	50	-	1.50	-	.10
3MVR0312AH	39007	1/32	-	.0312	1/8	-	1-1/2	-	0.094	-	-	-
3MVR0312R.005AH	39075	1/32	-	.0312	1/8	-	1-1/2	-	0.094	-	.005	-
3MVR0312R.010AH	39079	1/32	-	.0312	1/8	-	1-1/2	-	0.094	-	.010	-
3MVRM0100AH	39015	-	1.00	.0394	-	4	-	50	-	3.00	-	-
3MVRM0100R.10AH	39083	-	1.00	.0394	-	4	-	50	-	3.00	-	.10
3MVR0468AH	39019	3/64	-	.0468	1/8	-	1-1/2	-	0.140	-	-	-
3MVR0468R.005AH	39087	3/64	-	.0468	1/8	-	1-1/2	-	0.140	-	.005	-
3MVR0468R.010AH	39091	3/64	-	.0468	1/8	-	1-1/2	-	0.140	-	.010	-
3MVRM0150AH	39024	-	1.50	.0591	-	4	-	50	-	4.50	-	-
3MVRM0150R.20AH	39095	-	1.50	.0591	-	4	-	50	-	4.50	-	.20
3MVR0625AH	39026	1/16	-	.0625	1/8	-	1-1/2	-	0.188	-	-	-
3MVR0625R.005AH	39099	1/16	-	.0625	1/8	-	1-1/2	-	0.188	-	.005	-
3MVR0625R.010AH	39103	1/16	-	.0625	1/8	-	1-1/2	-	0.188	-	.010	-
3MVR0625R.015AH	39107	1/16	-	.0625	1/8	-	1-1/2	-	0.188	-	.015	-
3MVR0781AH	39034	5/64	-	.0781	1/8	-	1-1/2	-	0.234	-	-	-
3MVR0781R.005AH	39111	5/64	-	.0781	1/8	-	1-1/2	-	0.234	-	.005	-
3MVR0781R.010AH	39115	5/64	-	.0781	1/8	-	1-1/2	-	0.234	-	.010	-
3MVR0781R.015AH	39119	5/64	-	.0781	1/8	-	1-1/2	-	0.234	-	.015	-
3MVRM0200AH	39039	-	2.00	.0787	-	4	-	50	-	6.00	-	-
3MVRM0200R.20AH	39123	-	2.00	.0787	-	4	-	50	-	6.00	-	.20
3MVR0938AH	39043	3/32	-	.0938	1/8	-	1-1/2	-	.281	-	-	-
3MVR0938R.005AH	39127	3/32	-	.0938	1/8	-	1-1/2	-	.281	-	.005	-
3MVR0938R.010AH	39131	3/32	-	.0938	1/8	-	1-1/2	-	.281	-	.010	-
3MVR0938R.015AH	39135	3/32	-	.0938	1/8	-	1-1/2	-	.281	-	.015	-
3MVR0938R.020AH	39139	3/32	-	.0938	1/8	-	1-1/2	-	.281	-	.020	-

Inch	
D1	Tolerance
.0156 - .1250	+0/--.0008

Inch	
D2	Tolerance (h6)
.1250	+0/--.00031

Metric (mm)	
D1	Tolerance
0.5 - 3.0	+0/--.020

Metric (mm)	
D2	Tolerance (h6)
4.0	+0/--.008



Page 113



Series 3MVR Continued

Altima® 52		Diameter			Shank Diameter		OAL		Flute Length		Corner Radius	
Tool Number	EDP	D1			D2		L1		L2		R	
		Fraction	mm	Decimal	Inch	mm	Inch	mm	Inch	mm	Inch	mm
3MVRM0250AH	39051	-	2.50	.0984	-	4	-	50	-	7.50	-	-
3MVR1094AH	39053	7/64	-	.1094	1/8	-	1-1/2	-	0.328	-	-	-
3MVRM0300AH	39057	-	3.00	.1181	-	4	-	50	-	9.00	-	-
3MVRM0300R.20AH	39143	-	3.00	.1181	-	4	-	50	-	9.00	-	.20
3MVR1250AH	39061	1/8	-	.1250	1/8	-	1-1/2	-	0.375	-	-	-
3MVR1250R.005AH	39147	1/8	-	.1250	1/8	-	1-1/2	-	0.375	-	.005	-
3MVR1250R.010AH	39151	1/8	-	.1250	1/8	-	1-1/2	-	0.375	-	.010	-
3MVR1250R.015AH	39155	1/8	-	.1250	1/8	-	1-1/2	-	0.375	-	.015	-
3MVR1250R.020AH	39159	1/8	-	.1250	1/8	-	1-1/2	-	0.375	-	.020	-



Page 113

Series 3MVR

TuffCut®

3
Flute

MICRO End Mills



Series 156

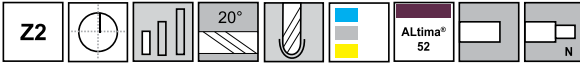

• Series 156 is designed for high-productivity milling of hard and difficult to cut materials Rc 45-60. Coated with ALtima® 52 for materials Rc 52 and above.

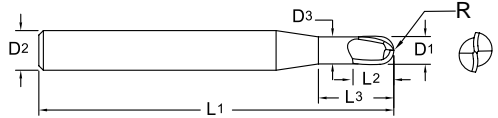

Series 156

TuffCut DM®

2 FL Ball

MICRO End Mills

ALtima® 52		Diameter			Shank		Neck Diameter		OAL		Flute Length		Neck Length	
Tool No.	EDP	D1			D2 (h5)		D3		L1		L2		L3	
		Inch	mm	Decimal	Inch	mm	Inch	mm	Inch	mm	Inch	mm	Inch	mm
15601560A	15600	1/64	-	.0156	1/4	-	-	-	2-1/2	-	1/64	-	-	-
156M0050N1A	15400	-	0.5	.0196	-	4.0	-	0.47	-	50	-	0.35	-	1
156M0050N2A	15401	-	0.5	.0196	-	4.0	-	0.47	-	50	-	0.35	-	2
156M0050N3A	15402	-	0.5	.0196	-	4.0	-	0.47	-	50	-	0.35	-	3
156M0050N4A	15403	-	0.5	.0196	-	4.0	-	0.47	-	50	-	0.35	-	4
156M0050N5A	15404	-	0.5	.0196	-	4.0	-	0.47	-	50	-	0.35	-	5
156M0050N6A	15406	-	0.5	.0196	-	4.0	-	0.47	-	50	-	0.35	-	6
15601960A	15602	-	0.5	.0196	-	6.0	-	-	-	63	-	0.50	-	-
156M0060N2A	15409	-	0.6	.0236	-	4.0	-	0.57	-	50	-	0.40	-	2
156M0060N4A	15411	-	0.6	.0236	-	4.0	-	0.57	-	50	-	0.40	-	4
156M0060N6A	15413	-	0.6	.0236	-	4.0	-	0.57	-	50	-	0.40	-	6
156M0060N8A	15415	-	0.6	.0236	-	4.0	-	0.57	-	50	-	0.40	-	8
156M0060N10A	15417	-	0.6	.0236	-	4.0	-	0.57	-	50	-	0.40	-	10
15603120A	15604	1/32	--	.0312	1/4	-	-	-	2-1/2	-	1/32	-	-	-
15603121A	15606	1/32	-	.0312	1/4	-	.0300	-	2-1/2	-	1/32	-	1/4	-
15603122A	15608	1/32	-	.0312	1/4	-	.0300	-	2-1/2	-	1/32	-	5/16	-
15603123A	15610	1/32	-	.0312	1/4	-	.0300	-	2-1/2	-	1/32	-	3/8	-
15603124A	15612	1/32	-	.0312	1/4	-	.0300	-	2-1/2	-	1/32	-	1/2	-
15603125A	15614	1/32	-	.0312	1/4	-	.0300	-	2-1/2	-	1/32	-	5/8	-
156M0080N2A	15419	-	0.8	.0315	-	4.0	-	0.77	-	50	-	0.50	-	2
156M0080N4A	15420	-	0.8	.0315	-	4.0	-	0.77	-	50	-	0.50	-	4
156M0080N6A	15422	-	0.8	.0315	-	4.0	-	0.77	-	50	-	0.50	-	6
156M0080N8A	15423	-	0.8	.0315	-	4.0	-	0.77	-	50	-	0.50	-	8
156M0080N10A	15424	-	0.8	.0315	-	4.0	-	0.77	-	50	-	0.50	-	10
156M0100N2A	15425	-	1.0	.0394	-	4.0	-	0.96	-	50	-	0.80	-	2

Inch	
D1	Tolerance
1/64 - 1/8	+0/-0.0005

Inch	
D2	Tolerance (h5)
.1182 - .2362	+0/-0.00020
.2363 - .3937	+0/-0.00024

Metric (mm)	
D1	Tolerance
0.50 - 3.00	+0/-0.015

Metric (mm)	
D2	Tolerance (h5)
3.01 - 6.00	+0/-0.005

Inch	
R	Tolerance
1/64 - 1/8	+0.0004/-0.0004

Metric (mm)	
R	Tolerance
0.5 - 3.0	+0.01/-0.01





Series 156 Continued

ALtima [®] 52		Diameter			Shank		Neck Diameter		OAL		Flute Length		Neck Length	
Tool No.	EDP	D1			D2 (h5)		D3		L1		L2		L3	
		Inch	mm	Decimal	Inch	mm	Inch	mm	Inch	mm	Inch	mm	Inch	mm
156M0100N3A	15426	-	1.0	.0394	-	4.0	-	0.96	-	50	-	0.80	-	3
156M0100N4A	15427	-	1.0	.0394	-	4.0	-	0.96	-	50	-	0.80	-	4
156M0100N6A	15429	-	1.0	.0394	-	4.0	-	0.96	-	50	-	0.80	-	6
156M0100N10A	15431	-	1.0	.0394	-	4.0	-	0.96	-	50	-	0.80	-	10
156M0100N12A	15432	-	1.0	.0394	-	4.0	-	0.96	-	63	-	0.80	-	12
156M0100N14A	15433	-	1.0	.0394	-	4.0	-	0.96	-	63	-	0.80	-	14
156M0100N16A	15434	-	1.0	.0394	-	4.0	-	0.96	-	63	-	0.80	-	16
156M0100N18A	15435	-	1.0	.0394	-	4.0	-	0.96	-	63	-	0.80	-	18
156M0100N20A	15436	-	1.0	.0394	-	4.0	-	0.96	-	63	-	0.80	-	20
15603940A	15616	-	1.0	.0394	-	6.0	-	-	-	63	-	1.00	-	-
15603941A	15618	-	1.0	.0394	-	6.0	-	0.96	-	63	-	1.00	-	6
15603942A	15620	-	1.0	.0394	-	6.0	-	0.96	-	63	-	1.00	-	8
15603943A	15622	-	1.0	.0394	-	6.0	-	0.96	-	63	-	1.00	-	10
15603944A	15624	-	1.0	.0394	-	6.0	-	0.96	-	63	-	1.00	-	12
15603945A	15626	-	1.0	.0394	-	6.0	-	0.96	-	63	-	1.00	-	16
156M0120N8A	15437	-	1.2	.0472	-	4.0	-	1.15	-	50	-	1.10	-	8
156M0120N12A	15438	-	1.2	.0472	-	4.0	-	1.15	-	63	-	1.10	-	12
156M0140N8A	15439	-	1.4	.0551	-	4.0	-	1.34	-	50	-	1.30	-	8
156M0140N12A	15440	-	1.4	.0551	-	4.0	-	1.34	-	63	-	1.30	-	12
156M0140N16A	15441	-	1.4	.0551	-	4.0	-	1.34	-	63	-	1.30	-	16
156M0150N4A	15442	-	1.5	.0591	-	4.0	-	1.44	-	50	-	1.35	-	4
156M0150N8A	15444	-	1.5	.0591	-	4.0	-	1.44	-	50	-	1.35	-	8
156M0150N16A	15446	-	1.5	.0591	-	4.0	-	1.44	-	63	-	1.35	-	16
156M0150N20A	15447	-	1.5	.0591	-	4.0	-	1.44	-	63	-	1.35	-	20
15605910A	15628	-	1.5	.0591	-	6.0	-	-	-	63	-	1.50	-	-
15606250A	15630	1/16	-	.0625	1/4	-	-	-	2-1/2	-	1/16	-	-	-
156M0160N8A	15448	-	1.6	.0630	-	4.0	-	1.54	-	50	-	1.40	-	8
156M0160N12A	15449	-	1.6	.0630	-	4.0	-	1.54	-	63	-	1.40	-	12
156M0160N16A	15450	-	1.6	.0630	-	4.0	-	1.54	-	63	-	1.40	-	16
156M0160N20A	15451	-	1.6	.0630	-	4.0	-	1.54	-	63	-	1.40	-	20
156M0180N8A	15452	-	1.8	.0709	-	4.0	-	1.73	-	50	-	1.60	-	8
156M0180N12A	15453	-	1.8	.0709	-	4.0	-	1.73	-	63	-	1.60	-	12
156M0180N16A	15454	-	1.8	.0709	-	4.0	-	1.73	-	63	-	1.60	-	16
156M0180N20A	15455	-	1.8	.0709	-	4.0	-	1.73	-	63	-	1.60	-	20
156M0200N3A	15456	-	2.0	.0787	-	4.0	-	1.92	-	50	-	1.70	-	3
156M0200N4A	15457	-	2.0	.0787	-	4.0	-	1.92	-	50	-	1.70	-	4
156M0200N6A	15458	-	2.0	.0787	-	4.0	-	1.92	-	50	-	1.70	-	6
156M0200N8A	15459	-	2.0	.0787	-	4.0	-	1.92	-	50	-	1.70	-	8
156M0200N10A	15460	-	2.0	.0787	-	4.0	-	1.92	-	50	-	1.70	-	10
156M0200N12A	15461	-	2.0	.0787	-	4.0	-	1.92	-	63	-	1.70	-	12
156M0200N16A	15463	-	2.0	.0787	-	4.0	-	1.92	-	63	-	1.70	-	16

Series 156

TuffCut DM[®]



MICRO End Mills



Page 116



Series 156 Continued

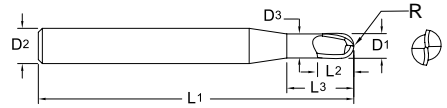

Altima [®] 52		Diameter			Shank		Neck Diameter		OAL		Flute Length		Neck Length	
Tool No.	EDP	D1			D2 (h5)		D3		L1		L2		L3	
		Inch	mm	Decimal	Inch	mm	Inch	mm	Inch	mm	Inch	mm	Inch	mm
156M0200N20A	15465	-	2.0	.0787	-	4.0	-	1.92	-	63	-	1.70	-	20
156M0200N25A	15467	-	2.0	.0787	-	4.0	-	1.92	-	80	-	1.70	-	25
156M0200N30A	15468	-	2.0	.0787	-	4.0	-	1.92	-	80	-	1.70	-	30
156M0200N35A	15469	-	2.0	.0787	-	4.0	-	1.92	-	80	-	1.70	-	35
156M0200N40A	15470	-	2.0	.0787	-	4.0	-	1.92	-	80	-	1.70	-	40
15607870A	15632	-	2.0	.0787	-	6.0	-	-	-	63	-	2.00	-	-
15607871A	15634	-	2.0	.0787	-	6.0	-	1.92	-	63	-	2.00	-	8
15607872A	15636	-	2.0	.0787	-	6.0	-	1.92	-	63	-	2.00	-	12
15607873A	15638	-	2.0	.0787	-	6.0	-	1.92	-	63	-	2.00	-	20
15609370A	15640	3/32	-	.0937	1/4	-	-	-	2-1/2	-	3/32	-	-	-
15609371A	15642	3/32	-	.0937	1/4	-	.0898	-	2-1/2	-	3/32	-	5/16	-
15609372A	15644	3/32	-	.0937	1/4	-	.0898	-	2-1/2	-	3/32	-	1/2	-
15609373A	15646	3/32	-	.0937	1/4	-	.0898	-	2-1/2	-	3/32	-	3/4	-
156M0300N8A	15471	-	3.0	.1181	-	6.0	-	2.90	-	75	-	2.50	-	8
156M0300N10A	15472	-	3.0	.1181	-	6.0	-	2.90	-	75	-	2.50	-	10
156M0300N16A	15474	-	3.0	.1181	-	6.0	-	2.90	-	75	-	2.50	-	16
156M0300N25A	15476	-	3.0	.1181	-	6.0	-	2.90	-	75	-	2.50	-	25
156M0300N30A	15477	-	3.0	.1181	-	6.0	-	2.90	-	75	-	2.50	-	30
156M0300N35A	15478	-	3.0	.1181	-	6.0	-	2.90	-	75	-	2.50	-	35
15611810A	15648	-	3.0	.1181	-	6.0	-	-	-	75	-	3.00	-	-
15611812A	15676	-	3.0	.1181	-	6.0	-	2.90	-	75	-	3.00	-	12
15611811A	15650	-	3.0	.1181	-	6.0	-	2.90	-	75	-	3.00	-	20
15612500A	15652	1/8	-	.1250	1/4	-	-	-	3	-	1/8	-	-	-
15612501A	15654	1/8	-	.1250	1/4	-	.1211	-	3	-	1/8	-	3/4	-

See full line catalog or visit www.maford.com for complete offering.





**NEW
Design**

Series 158

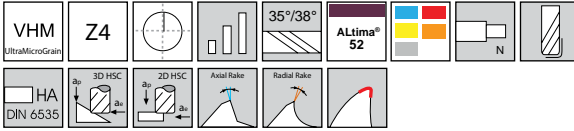

- For multi application roughing and finishing.
- Variable helix and unequal flute spacing for reduced vibration.
- Increased core diameter for improved stiffness.
- Special edge preparation for additional strength and reduced cutting edge stress.
- For application in alloy steels, tool steels, cast iron, titanium, heat resistant super alloys and hardened steels up to HRC60.

Diameter	Diameter Tolerance mm	R Tolerance mm	Shank Ø Tolerance
Ø2.0 - Ø3.0	+0 / - 0.02	-0.02 / +0.02	h6

Diameter	Diameter Tolerance inch	R Tolerance inch	Shank Ø Tolerance
Ø2.0 - Ø3.0	+0 / - 0.0008	-0.0008 / +0.0008	h6

Metric (mm)	
D2	Tolerance (h6)
0 - 3.0	+0/- .006
3.01 - 6.0	+0/- .008

Inch	
D2	Tolerance (h6)
.0000 - .1181	+0/- .00024
.1182 - .2362	+0/- .00031

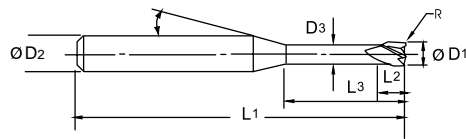

ALtima [®] 52		Diameter		Shank	Neck Diameter	OAL	Flute Length	Neck Length	Corner Radius
Tool No.	EDP	mm	Decimal						
158M02N06-0.1RA	99150	2	0.0787	6	1.9	63	3	6	R0.1
158M02N06-0.2RA	99155	2	0.0787	6	1.9	63	3	6	R0.2
158M02N08-0.1RA	99151	2	0.0787	6	1.9	63	3	8	R0.1
158M02N08-0.2RA	99156	2	0.0787	6	1.9	63	3	8	R0.2
158M02N08-0.5RA	99160	2	0.0787	6	1.9	63	3	8	R0.5
158M02N12-0.1RA	99152	2	0.0787	6	1.9	63	3	12	R0.1
158M02N12-0.2RA	99157	2	0.0787	6	1.9	63	3	12	R0.2
158M02N16-0.1RA	99153	2	0.0787	6	1.9	63	3	16	R0.1
158M02N16-0.2RA	99158	2	0.0787	6	1.9	63	3	16	R0.2
158M02N20-0.1RA	99154	2	0.0787	6	1.9	75	3	20	R0.1
158M02N20-0.2RA	99159	2	0.0787	6	1.9	75	3	20	R0.2
158M03N10-0.2RA	99161	3	0.1181	6	2.9	63	5	10	R0.2
158M03N10-0.5RA	99167	3	0.1181	6	2.9	63	5	10	R0.5
158M03N10-0.8RA	99173	3	0.1181	6	2.9	63	5	10	R0.8
158M03N12-0.2RA	99162	3	0.1181	6	2.9	63	5	12	R0.2
158M03N12-0.5RA	99168	3	0.1181	6	2.9	63	5	12	R0.5
158M03N16-0.2RA	99163	3	0.1181	6	2.9	63	5	16	R0.2
158M03N16-0.5RA	99169	3	0.1181	6	2.9	63	5	16	R0.5

Series 158

TuffCut DM[®]

4 Flute

MICRO End Mills





Series 158 Continued

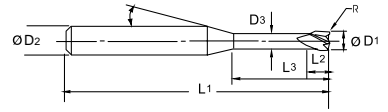

ALtima [®] 52		Diameter		Shank	Neck Diameter	OAL	Flute Length	Neck Length	Corner Radius
Tool No.	EDP	D1							
		mm	Decimal	D2 (h6)	D3	L1	L2	L3	R
158M03N20-0.2RA	99164	3	0.1181	6	2.9	75	5	20	R0.2
158M03N20-0.5RA	99170	3	0.1181	6	2.9	75	5	20	R0.5
158M03N25-0.2RA	99165	3	0.1181	6	2.9	75	5	25	R0.2
158M03N25-0.5RA	99171	3	0.1181	6	2.9	75	5	25	R0.5
158M03N30-0.2RA	99166	3	0.1181	6	2.9	75	5	30	R0.2
158M03N30-0.5RA	99172	3	0.1181	6	2.9	75	5	30	R0.5

See full line catalog or visit www.maford.com for complete offering.



Page 118

Series 158

TuffCut DM[®]

MICRO End Mills

4 Flute



Series 111

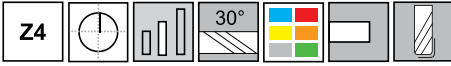

- Designed for aggressive milling of most materials.

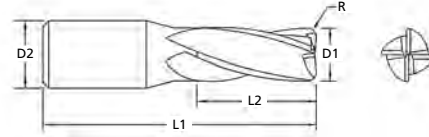

Tool No.	EDP	Diameter			Shank		OAL		Flute Length		Corner Radius	
		D1			D2		L1		L2		R	
		Inch	mm	Decimal	Inch	mm	Inch	mm	Inch	mm	Inch	mm
11100500	51001	-	-	.0050*	1/8	-	1-1/2	-	.015	-	-	-
11100780	51003	-	0.2	.0078*	-	3.0	-	38	-	0.6	-	-
11101000	51005	-	-	.0100*	1/8	-	1-1/2	-	.030	-	-	-
11101180	51007	-	0.3	.0118*	-	3.0	-	38	-	0.9	-	-
11101500	51009	-	-	.0150*	1/8	-	1-1/2	-	.045	-	-	-
11101560	11011	1/64	-	.0156	1/8	-	1-1/2	-	1/32	-	-	-
11101570	51013	-	0.4	.0157	-	3.0	-	38	-	1.2	-	-
11101960	51015	-	0.5	.0196	-	3.0	-	38	-	1.5	-	-
11102000	51017	-	-	.0200	1/8	-	1-1/2	-	.060	-	-	-
11102360	51019	-	0.6	.0236	-	3.0	-	38	-	1.8	-	-
11102500	51021	-	-	.0250	1/8	-	1-1/2	-	.075	-	-	-
11102750	51023	-	0.7	.0275	-	3.0	-	38	-	2.1	-	-
11103000	51025	-	-	.0300	1/8	-	1-1/2	-	.090	-	-	-
11103120	11027	1/32	-	.0312	1/8	-	1-1/2	-	5/64	-	-	-
11103150	51029	-	0.8	.0315	-	3.0	-	38	-	2.4	-	-
11103500	51031	-	-	.0350	1/8	-	1-1/2	-	.105	-	-	-
11103540	51033	-	0.9	.0354	-	3.0	-	38	-	2.7	-	-
11103940	11035	-	1.0	.0394	-	3.0	-	38	-	3.0	-	-
11104000	51039	-	-	.0400	1/8	-	1-1/2	-	.120	-	-	-
11104330	51041	-	1.1	.0433	-	3.0	-	38	-	3.3	-	-
11104500	51043	-	-	.0450	1/8	-	1-1/2	-	.135	-	-	-
11104680	11045	3/64	-	.0468	1/8	-	1-1/2	-	7/64	-	-	-
11104720	51047	-	1.2	.0472	-	3.0	-	38	-	3.6	-	-

*End mills 0.015" (0.3mm) and smaller are non-center cutting.

Inch	
D1	Tolerance
1/64	+ .000/- .001
1/32 - 1/8	+ .000/- .002
D1 Micro Sizes*	Tolerance
.005 - .100	+ .0005/- .0005

Metric (mm)	
D1	Tolerance (h10)
0.20 - 0.50	+ .000/- .025
0.60 - 3.00	+ .000/- .040

Inch	
R	Tolerance
1/8	+ .002/- .002

Metric (mm)	
R	Tolerance
3.0	+ .05/- .05



*Inch decimal size range .005 - .100 only.



Series 111 Continued

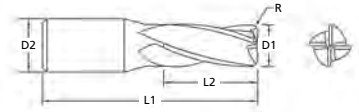

Tool No.	EDP	Diameter			Shank		OAL		Flute Length		Corner Radius	
		D1			D2		L1		L2		R	
		Inch	mm	Decimal	Inch	mm	Inch	mm	Inch	mm	Inch	mm
11105000	51049	-	-	.0500	1/8	-	1-1/2	-	.150	-	-	-
11105120	51051	-	1.3	.0512	-	3.0	-	38	-	3.9	-	-
11105500	51053	-	-	.0550	1/8	-	1-1/2	-	.165	-	-	-
11105510	51055	-	1.4	.0551	-	3.0	-	38	-	4.2	-	-
11105910	11057	-	1.5	.0591	-	3.0	-	38	-	6.0	-	-
11105911	51057	-	1.5	.0591	-	3.0	-	38	-	4.5	-	-
11106000	51061	-	-	.0600	1/8	-	1-1/2	-	.180	-	-	-
11106250	11063	1/16	-	.0625	1/8	-	1-1/2	-	3/16	-	-	-
11106300	51065	-	1.6	.0630	-	3.0	-	38	-	4.8	-	-
11106500	51067	-	-	.0650	1/8	-	1-1/2	-	.195	-	-	-
11106690	51069	-	1.7	.0669	-	3.0	-	38	-	5.1	-	-
11107000	51071	-	-	.0700	1/8	-	1-1/2	-	.210	-	-	-
11107090	51073	-	1.8	.0709	-	3.0	-	38	-	5.4	-	-
11107480	51075	-	1.9	.0748	-	3.0	-	38	-	5.7	-	-
11107500	51077	-	-	.0750	1/8	-	1-1/2	-	.225	-	-	-
11107810	11079	5/64	-	.0781	1/8	-	1-1/2	-	3/16	-	-	-
11107870	11081	-	2.0	.0787	-	3.0	-	38	-	9.0	-	-
11107871	51081	-	2.0	.0787	-	3.0	-	38	-	6.0	-	-
11108000	51085	-	-	.0800	1/8	-	1-1/2	-	.240	-	-	-
11108500	51087	-	-	.0850	1/8	-	1-1/2	-	.255	-	-	-
11109000	51089	-	-	.0900	1/8	-	1-1/2	-	.270	-	-	-
11109370	11091	3/32	-	.0937	1/8	-	1-1/2	-	9/32	-	-	-
11109500	51093	-	-	.0950	1/8	-	1-1/2	-	.285	-	-	-
11109840	11095	-	2.5	.0984	-	3.0	-	38	-	12.0	-	-
11110010	51099	-	-	.1000	1/8	-	1-1/2	-	.300	-	-	-
11110930	11101	7/64	-	.1093	1/8	-	1-1/2	-	3/8	-	-	-
11111810	11103	-	3.0	.1181	-	3.0	-	38	-	12.0	-	-
11111811	51402	-	3.0	.1181	-	3.0	-	38	-	12.0	-	0.50
11112500	11105	1/8	-	.1250	1/8	-	1-1/2	-	3/8	-	-	-
11112501	11108	1/8	-	.1250	1/8	-	1-1/2	-	1/2	-	-	-
11112511	51401	1/8	-	.1250	1/8	-	1-1/2	-	3/8	-	0.015	-
11112512	51403	1/8	-	.1250	1/8	-	1-1/2	-	3/8	-	0.020	-

See full line catalog or visit www.maford.com for complete offering.





Series 111 Coated

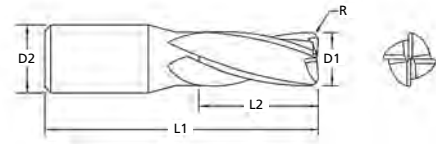

TiN		Diameter			Shank		OAL		Flute Length	
TiN		D1			D2		L1		L2	
Tool No.	EDP	Inch	mm	Decimal	Inch	mm	Inch	mm	Inch	mm
11111810T	11104	-	3.0	.1181	-	3.0	-	38	-	12.0
11112500T	11106	1/8	-	.1250	1/8	-	1-1/2	-	3/8	-



ALtima®		Diameter			Shank		OAL		Flute Length	
ALtima®		D1			D2		L1		L2	
Tool No.	EDP	Inch	mm	Decimal	Inch	mm	Inch	mm	Inch	mm
11103940A	11036	-	1.0	.0394	-	3.0	-	38	-	3.0
11105910A	11058	-	1.5	.0591	-	3.0	-	38	-	6.0
11107870A	11082	-	2.0	.0787	-	3.0	-	38	-	9.0
11109840A	11096	-	2.5	.0984	-	3.0	-	38	-	12.0
11111810A	11003	-	3.0	.1181	-	3.0	-	38	-	12.0
11112500A	11005	1/8	-	.1250	1/8	-	1-1/2	-	3/8	-



TiCN		Diameter			Shank		OAL		Flute Length	
TiCN		D1			D2		L1		L2	
Tool No.	EDP	Inch	mm	Decimal	Inch	mm	Inch	mm	Inch	mm
11111810C	11004	-	3.0	.1181	-	3.0	-	38	-	12.0
11112500C	11006	1/8	-	.1250	1/8	-	1-1/2	-	3/8	-

See full line catalog or visit www.maford.com for complete offering.





Series 163

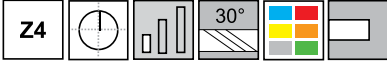

- Designed for aggressive milling of most materials with reduced deflection, improved tool life and overall economy

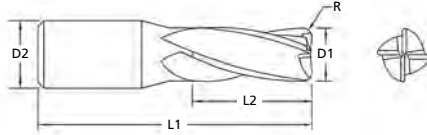

Series 163

TuffCut® GP

MICRO End Mills

4 Flute

Tool No.	EDP	Diameter			Shank		OAL		Flute Length	
		D1			D2		L1		L2	
		Inch	mm	Decimal	Inch	mm	Inch	mm	Inch	mm
16300500	16302	-	-	.0050	1/8	-	1-1/2	-	.010	-
16300600	16304	-	-	.0060	1/8	-	1-1/2	-	.012	-
16300700	16306	-	-	.0070	1/8	-	1-1/2	-	.014	-
16300800	16308	-	-	.0080	1/8	-	1-1/2	-	.016	-
16300900	16312	-	-	.0090	1/8	-	1-1/2	-	.018	-
16301000	16314	-	-	.0100	1/8	-	1-1/2	-	.020	-
16301100	16318	-	-	.0110	1/8	-	1-1/2	-	.022	-
16301200	16320	-	-	.0120	1/8	-	1-1/2	-	.024	-
16301300	16328	-	-	.0130	1/8	-	1-1/2	-	.026	-
16301400	16330	-	-	.0140	1/8	-	1-1/2	-	.028	-
16301500	16334	-	-	.0150	1/8	-	1-1/2	-	.030	-
16301560	16300	1/64	-	.0156	1/8	-	1-1/2	-	.023	-
16301600	16338	-	-	.0160	1/8	-	1-1/2	-	.032	-
16301700	16340	-	-	.0170	1/8	-	1-1/2	-	.034	-
16301800	16344	-	-	.0180	1/8	-	1-1/2	-	.036	-
16301900	16346	-	-	.0190	1/8	-	1-1/2	-	.038	-
16302000	16348	-	-	.0200	1/8	-	1-1/2	-	.040	-
16302100	16350	-	-	.0210	1/8	-	1-1/2	-	.042	-
16302200	16352	-	-	.0220	1/8	-	1-1/2	-	.044	-
16302300	16354	-	-	.0230	1/8	-	1-1/2	-	.046	-
16302400	16356	-	-	.0240	1/8	-	1-1/2	-	.048	-
16302500	16358	-	-	.0250	1/8	-	1-1/2	-	.050	-
16302600	16360	-	-	.0260	1/8	-	1-1/2	-	.052	-
16302700	16362	-	-	.0270	1/8	-	1-1/2	-	.054	-
16302800	16364	-	-	.0280	1/8	-	1-1/2	-	.056	-
16302900	16366	-	-	.0290	1/8	-	1-1/2	-	.058	-
16303000	16368	-	-	.0300	1/8	-	1-1/2	-	.060	-

Inch	
D1	Tolerance
1/64	+ .000/- .001
1/32 - 1/8	+ .000/- .002

Inch	
D1 Micro Sizes*	Tolerance
.005 - .060	+ .0005/- .0005

Metric (mm)	
D1	Tolerance (h10)
1.00 - 3.00	+ .000/- .040

* Inch decimal size range .005 - .060" only.



Page 127



Series 163 Continued

Tool No.	EDP	Diameter			Shank		OAL		Flute Length	
		D1			D2		L1		L2	
		Inch	mm	Decimal	Inch	mm	Inch	mm	Inch	mm
16303100	16370	-	-	.0310	1/8	-	1-1/2	-	.062	-
16303120	16301	1/32	-	.0312	1/8	-	1-1/2	-	1/16	-
16303200	16372	-	-	.0320	1/8	-	1-1/2	-	.064	-
16303300	16373	-	-	.0330	1/8	-	1-1/2	-	.066	-
16303400	16374	-	-	.0340	1/8	-	1-1/2	-	.068	-
16303500	16375	-	-	.0350	1/8	-	1-1/2	-	.070	-
16303600	16376	-	-	.0360	1/8	-	1-1/2	-	.072	-
16303700	16377	-	-	.0370	1/8	-	1-1/2	-	.074	-
16303800	16378	-	-	.0380	1/8	-	1-1/2	-	.076	-
16303900	16379	-	-	.0390	1/8	-	1-1/2	-	.078	-
16303940	16303	-	1.0	.0394	-	3.0	-	38	-	2.0
16304000	16380	-	-	.0400	1/8	-	1-1/2	-	.080	-
16304100	16381	-	-	.0410	1/8	-	1-1/2	-	.082	-
16304200	16382	-	-	.0420	1/8	-	1-1/2	-	.084	-
16304300	16383	-	-	.0430	1/8	-	1-1/2	-	.086	-
16304400	16384	-	-	.0440	1/8	-	1-1/2	-	.088	-
16304500	16385	-	-	.0450	1/8	-	1-1/2	-	.090	-
16304600	16386	-	-	.0460	1/8	-	1-1/2	-	.092	-
16304680	16305	3/64	-	.0468	1/8	-	1-1/2	-	3/32	-
16304700	16387	-	-	.0470	1/8	-	1-1/2	-	.094	-
16304800	16388	-	-	.0480	1/8	-	1-1/2	-	.096	-
16304900	16389	-	-	.0490	1/8	-	1-1/2	-	.098	-
16305000	16390	-	-	.0500	1/8	-	1-1/2	-	.100	-
16305100	16391	-	-	.0510	1/8	-	1-1/2	-	.102	-
16305200	16392	-	-	.0520	1/8	-	1-1/2	-	.104	-
16305300	16393	-	-	.0530	1/8	-	1-1/2	-	.106	-
16305400	16394	-	-	.0540	1/8	-	1-1/2	-	.108	-
16305500	16395	-	-	.0550	1/8	-	1-1/2	-	.110	-
16305600	16396	-	-	.0560	1/8	-	1-1/2	-	.112	-
16305700	16397	-	-	.0570	1/8	-	1-1/2	-	.114	-
16305800	16398	-	-	.0580	1/8	-	1-1/2	-	.116	-
16305900	16399	-	-	.0590	1/8	-	1-1/2	-	.118	-
16305910	16307	-	1.5	.0591	-	3.0	-	38	-	3.0
16306000	16324	--	-	.0600	1/8	-	1-1/2	-	.120	-
16306250	16309	1/16	-	.0625	1/8	-	1-1/2	-	1/8	-
16307810	16310	5/64	-	.0781	1/8	-	1-1/2	-	5/32	-
16307870	16311	-	2.0	.0787	-	3.0	-	38	-	4.0
16309370	16313	3/32	-	.0937	1/8	-	1-1/2	-	3/16	-
16309840	16315	-	2.5	.0984	-	3.0	-	38	-	5.0
16310930	16316	7/64	-	.1093	1/8	-	1-1/2	-	7/32	-
16311810	16317	-	3.0	.1181	--	3.0	-	38	-	6.0
16312500	16319	1/8	-	.1250	1/8	-	1-1/2	-	1/4	-

Series 163

TuffCut® GP

4 Flute

MICRO End Mills



See full line catalog or visit www.maform.com for complete offering.



Series 116

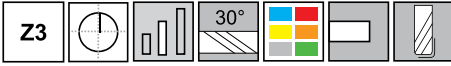

• Corner Radius Options Now Available As Standard!

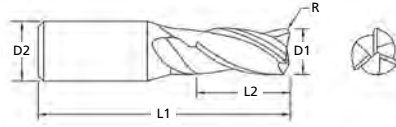

Series 116

TuffCut® GP

MICRO End Mills

3 Flute

Tool No.	EDP	Diameter			Shank		OAL		Flute Length		Corner Radius
		D1			D2		L1		L2		R
		Inch	mm	Decimal	Inch	mm	Inch	mm	Inch	mm	Inch
11601560	11601	1/64	-	.0156	1/8	-	1-1/2	-	1/32	-	-
11603120	11603	1/32	-	.0312	1/8	-	1-1/2	-	5/64	-	-
11603940	11605	-	1.0	.0394	-	3.0	-	38	-	3.0	-
11604680	11607	3/64	-	.0468	1/8	-	1-1/2	-	7/64	-	-
11605910	11609	-	1.5	.0591	-	3.0	-	38	-	6.0	-
11606250	11611	1/16	-	.0625	1/8	-	1-1/2	-	3/16	-	-
11606250R.005	16197	1/16	-	.0625	1/8	-	1-1/2	-	3/16	-	.005
11606250R.010	16102	1/16	-	.0625	1/8	-	1-1/2	-	3/16	-	.010
11606250R.015	16104	1/16	-	.0625	1/8	-	1-1/2	-	3/16	-	.015
11606250R.020	16106	1/16	-	.0625	1/8	-	1-1/2	-	3/16	-	.020
11607810	11613	5/64	-	.0781	1/8	-	1-1/2	-	3/16	-	-
11607810R.005	16198	5/64	-	.0781	1/8	-	1-1/2	-	3/16	-	.005
11607810R.010	16108	5/64	-	.0781	1/8	-	1-1/2	-	3/16	-	.010
11607810R.015	16110	5/64	-	.0781	1/8	-	1-1/2	-	3/16	-	.015
11607810R.020	16112	5/64	-	.0781	1/8	-	1-1/2	-	3/16	-	.020
11607870	11615	-	2.0	.0787	-	3.0	-	38	-	9.0	-
11609370	11617	3/32	-	.0937	1/8	-	1-1/2	-	9/32	-	-
11609370R.005	16199	3/32	-	.0937	1/8	-	1-1/2	-	9/32	-	.005
11609370R.010	16114	3/32	-	.0937	1/8	-	1-1/2	-	9/32	-	.010
11609370R.015	16116	3/32	-	.0937	1/8	-	1-1/2	-	9/32	-	.015
11609370R.020	16118	3/32	-	.0937	1/8	-	1-1/2	-	9/32	-	.020
11609840	11619	-	2.5	.0984	-	3.0	-	38	-	12.0	-
11610930	11623	7/64	-	.1093	1/8	-	1-1/2	-	3/8	-	-
11611810	11625	-	3.0	.1181	-	3.0	-	38	-	12.0	-
11612500	11627	1/8	-	.1250	1/8	-	1-1/2	-	3/8	-	-
11612500R.005	16202	1/8	-	.1250	1/8	-	1-1/2	-	3/8	-	.005
11612500R.010	16120	1/8	-	.1250	1/8	-	1-1/2	-	3/8	-	.010
11612500R.015	16122	1/8	-	.1250	1/8	-	1-1/2	-	3/8	-	.015
11612500R.020	16124	1/8	-	.1250	1/8	-	1-1/2	-	3/8	-	.020
11612501	11630	1/8	-	.1250	1/8	-	1-1/2	-	1/2	-	-

Inch	
D1	Tolerance
1/64	+ .000/- .001
1/32 - 1/8	+ .000/- .002

Metric (mm)	
D1	Tolerance (h10)
1.00 - 3.00	+ .000/- .040

See full line catalog or visit www.mafood.com for complete offering.





Series 116 Coated

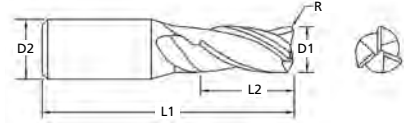

TiN		ALtima®		Diameter			Shank D2	OAL L1	Flute Length L2	Corner Radius R
Tool No.	EDP	Tool No.	EDP	D1						
				Inch	mm	Decimal				
-	-	11603940A	11606	-	1.0	.0394	3.0	38	3.0	-
-	-	11606250R.005A	16204	1/16	-	.0625	1/8	1-1/2	3/16	.005
-	-	11606250R.010A	16150	1/16	-	.0625	1/8	1-1/2	3/16	.010
-	-	11606250R.015A	16128	1/16	-	.0625	1/8	1-1/2	3/16	.015
-	-	11606250R.020A	16130	1/16	-	.0625	1/8	1-1/2	3/16	.020
-	-	11605910A	11610	-	1.5	.0591	3.0	38	6.0	-
-	-	11607810R.005A	16206	5/64	-	.0781	1/8	1-1/2	3/16	.005
-	-	11607810R.010A	16132	5/64	-	.0781	1/8	1-1/2	3/16	.010
-	-	11607810R.015A	16134	5/64	-	.0781	1/8	1-1/2	3/16	.015
-	-	11607810R.020A	16136	5/64	-	.0781	1/8	1-1/2	3/16	.020
-	-	11607870A	11616	-	2.0	.0787	3.0	38	9.0	-
-	-	11609370R.005A	16208	3/32	-	.0937	1/8	1-1/2	9/32	.005
-	-	11609370R.010A	16138	3/32	-	.0937	1/8	1-1/2	9/32	.010
-	-	11609370R.015A	16140	3/32	-	.0937	1/8	1-1/2	9/32	.015
-	-	11609370R.020A	16142	3/32	-	.0937	1/8	1-1/2	9/32	.020
-	-	11609840A	11620	-	2.5	.0984	3.0	38	12.0	-
11611810T	11626	11611810A	51603	-	3.0	.1181	3.0	38	12.0	-
11612500T	11628	11612500A	51605	1/8	-	.1250	1/8	1-1/2	3/8	-
-	-	11612500R.005A	16242	1/8	-	.1250	1/8	1-1/2	3/8	.005
-	-	11612500R.010A	16144	1/8	-	.1250	1/8	1-1/2	3/8	.010
-	-	11612500R.015A	16146	1/8	-	.1250	1/8	1-1/2	3/8	.015
-	-	11612500R.020A	16148	1/8	-	.1250	1/8	1-1/2	3/8	.020





Series 116 Coated Continued

Series 116 Coated

TuffCut® GP

MICRO End Mills

3 Flute

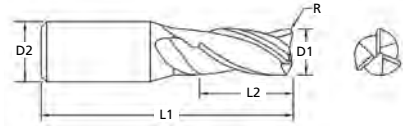

TiCN		Fordlube		Diameter			Shank D2	OAL L1	Flute Length L2	Corner Radius R
Tool No.	EDP	Tool No.	EDP	D1						
				Inch	mm	Decimal				
-	-	11606250R.005F	16210	1/16	-	.0625	1/8	1-1/2	3/16	.005
-	-	11606250R.010F	16212	1/16	-	.0625	1/8	1-1/2	3/16	.010
-	-	11606250R.015F	16214	1/16	-	.0625	1/8	1-1/2	3/16	.015
-	-	11606250R.020F	16216	1/16	-	.0625	1/8	1-1/2	3/16	.020
-	-	11607810R.005F	16218	5/64	-	.0781	1/8	1-1/2	3/16	.005
-	-	11607810R.010F	16220	5/64	-	.0781	1/8	1-1/2	3/16	.010
-	-	11607810R.015F	16222	5/64	-	.0781	1/8	1-1/2	3/16	.015
-	-	11607810R.020F	16224	5/64	-	.0781	1/8	1-1/2	3/16	.020
-	-	11609370R.005F	16227	3/32	-	.0937	1/8	1-1/2	9/32	.005
-	-	11609370R.010F	16228	3/32	-	.0937	1/8	1-1/2	9/32	.010
-	-	11609370R.015F	16230	3/32	-	.0937	1/8	1-1/2	9/32	.015
-	-	11609370R.020F	16232	3/32	-	.0937	1/8	1-1/2	9/32	.020
11611810C	51604	-	-	-	3.0	.1181	3.0	38	12.0	-
11612500C	51606	-	-	1/8	-	.1250	1/8	1-1/2	3/8	-
-	-	11612500R.005F	16234	1/8	-	.1250	1/8	1-1/2	3/8	.005
-	-	11612500R.010F	16238	1/8	-	.1250	1/8	1-1/2	3/8	.010
-	-	11612500R.015F	16239	1/8	-	.1250	1/8	1-1/2	3/8	.015
-	-	11612500R.020F	16240	1/8	-	.1250	1/8	1-1/2	3/8	.020

See full line catalog or visit www.maford.com for complete offering.





Series 169

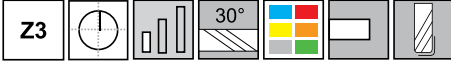

- Designed for aggressive milling of most materials. Provides reduced deflection, improved tool life and overall economy.

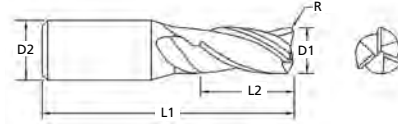

Tool No.	EDP	Diameter			Shank		OAL		Flute Length		Corner Radius
		D1			D2		L1		L2		R
		Inch	mm	Decimal	Inch	mm	Inch	mm	Inch	mm	Inch
16901560	16900	1/64	-	.0156	1/8	-	1-1/2	-	.023	-	-
16903120	16901	1/32	-	.0312	1/8	-	1-1/2	-	1/16	-	-
16903940	16903		1.0	.0394	-	3.0	-	38	-	2.0	-
16904680	16905	3/64	-	.0468	1/8	-	1-1/2	-	3/32	-	-
16905910	16907		1.5	.0591	-	3.0	-	38	-	3.0	-
16906250	16909	1/16	-	.0625	1/8	-	1-1/2	-	1/8	-	-
16906250R.005	16966	1/16	-	.0625	1/8	-	1-1/2	-	1/8	-	.005
16906250R.010	16910	1/16	-	.0625	1/8	-	1-1/2	-	1/8	-	.010
16906250R.015	16912	1/16	-	.0625	1/8	-	1-1/2	-	1/8	-	.015
16906250R.020	16914	1/16	-	.0625	1/8	-	1-1/2	-	1/8	-	.020
16907810	16911	5/64	-	.0781	1/8	-	1-1/2	-	5/32	-	-
16907810R.005	16968	5/64	-	.0781	1/8	-	1-1/2	-	5/32	-	.005
16907810R.010	16916	5/64	-	.0781	1/8	-	1-1/2	-	5/32	-	.010
16907810R.015	16918	5/64	-	.0781	1/8	-	1-1/2	-	5/32	-	.015
16907810R.020	16920	5/64	-	.0781	1/8	-	1-1/2	-	5/32	-	.020
16907870	16913		2.0	.0787	-	3.0	-	38	-	4.0	-
16909370	16915	3/32	-	.0937	1/8	-	1-1/2	-	3/16	-	-
16909370R.005	16970	3/32	-	.0937	1/8	-	1-1/2	-	3/16	-	.005
16909370R.010	16922	3/32	-	.0937	1/8	-	1-1/2	-	3/16	-	.010
16909370R.015	16924	3/32	-	.0937	1/8	-	1-1/2	-	3/16	-	.015
16909370R.020	16928	3/32	-	.0937	1/8	-	1-1/2	-	3/16	-	.020
16909840	16917		2.5	.0984	-	3.0	-	38	-	5.0	-
16910930	16919	7/64	-	.1093	1/8	-	1-1/2	-	7/32	-	-
16911810	16921		3.0	.1181	-	3.0	-	38	-	6.0	-
16912500	16923	1/8	-	.1250	1/8	-	1-1/2	-	1/4	-	-
16912500R.005	16972	1/8	-	.1250	1/8	-	1-1/2	-	1/4	-	.005
16912500R.010	16932	1/8	-	.1250	1/8	-	1-1/2	-	1/4	-	.010
16912500R.015	16934	1/8	-	.1250	1/8	-	1-1/2	-	1/4	-	.015
16912500R.020	16938	1/8	-	.1250	1/8	-	1-1/2	-	1/4	-	.020

Inch	
D1	Tolerance
1/64	+ .000/- .001
1/32 - 1/8	+ .000/- .002

Metric (mm)	
D1	Tolerance (h10)
1.00 - 3.00	+ .000/- .040

See full line catalog or visit www.maford.com for complete offering.





Series 169 Coated

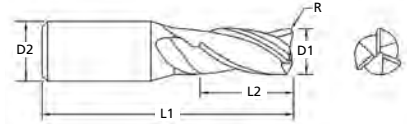

Series 169 Coated

TuffCut® GP

3 Flute
MICRO End Mills

TIN		ALtima®		Diameter			Shank	OAL	Flute Length	Corner Radius
Tool No.	EDP	Tool No.	EDP	D1						
				Inch	mm	Decimal	D2	L1	L2	R
-	-	16906250R.005A	16974	1/16	-	.0625	1/8	1-1/2	1/8	.005
-	-	16906250R.010A	16942	1/16	-	.0625	1/8	1-1/2	1/8	.010
-	-	16906250R.015A	16944	1/16	-	.0625	1/8	1-1/2	1/8	.015
-	-	16906250R.020A	16946	1/16	-	.0625	1/8	1-1/2	1/8	.020
-	-	16907810R.005A	16976	5/64	-	.0781	1/8	1-1/2	5/32	.005
-	-	16907810R.010A	16948	5/64	-	.0781	1/8	1-1/2	5/32	.010
-	-	16907810R.015A	16950	5/64	-	.0781	1/8	1-1/2	5/32	.015
-	-	16907810R.020A	16952	5/64	-	.0781	1/8	1-1/2	5/32	.020
-	-	16909370R.005A	16995	3/32	-	.0937	1/8	1-1/2	3/16	.005
-	-	16909370R.010A	16954	3/32	-	.0937	1/8	1-1/2	3/16	.010
-	-	16909370R.015A	16956	3/32	-	.0937	1/8	1-1/2	3/16	.015
-	-	16909370R.020A	16958	3/32	-	.0937	1/8	1-1/2	3/16	.020
16911810T	56900	16911810A	56933	-	3.0	.1181	3.0	38	6.0	-
16912500T	56901	16912500A	56934	1/8	-	.1250	1/8	1-1/2	1/4	-
-	-	16912500R.005A	16996	1/8	-	.1250	1/8	1-1/2	1/4	.005
-	-	16912500R.010A	16960	1/8	-	.1250	1/8	1-1/2	1/4	.010
-	-	16912500R.015A	16962	1/8	-	.1250	1/8	1-1/2	1/4	.015
-	-	16912500R.020A	16964	1/8	-	.1250	1/8	1-1/2	1/4	.020

See full line catalog or visit www.maford.com for complete offering.





Series 169 Coated Continued



TiCN		Flute		Diameter			Shank	OAL	Flute Length	Corner Radius
Tool No.	EDP	Tool No.	EDP	D1						
				Inch	mm	Decimal	D2	L1	L2	R
-	-	16906250R.005F	16997	1/16	-	.0625	1/8	1-1/2	1/8	.005
-	-	16906250R.010F	16998	1/16	-	.0625	1/8	1-1/2	1/8	.010
-	-	16906250R.015F	16999	1/16	-	.0625	1/8	1-1/2	1/8	.015
-	-	16906250R.020F	17000	1/16	-	.0625	1/8	1-1/2	1/8	.020
-	-	16907810R.005F	17001	5/64	-	.0781	1/8	1-1/2	5/32	.005
-	-	16907810R.010F	17002	5/64	-	.0781	1/8	1-1/2	5/32	.010
-	-	16907810R.015F	17003	5/64	-	.0781	1/8	1-1/2	5/32	.015
-	-	16907810R.020F	17004	5/64	-	.0781	1/8	1-1/2	5/32	.020
-	-	16909370R.005F	17005	3/32	-	.0937	1/8	1-1/2	3/16	.005
-	-	16909370R.010F	17006	3/32	-	.0937	1/8	1-1/2	3/16	.010
-	-	16909370R.015F	17007	3/32	-	.0937	1/8	1-1/2	3/16	.015
-	-	16909370R.020F	17008	3/32	-	.0937	1/8	1-1/2	3/16	.020
16911810C	56966	-	-	-	3.0	.1181	3.0	38	6.0	-
16912500C	56967	-	-	1/8	-	.1250	1/8	1-1/2	1/4	-
-	-	16912500R.005F	17009	1/8	-	.1250	1/8	1-1/2	1/4	.005
-	-	16912500R.010F	17010	1/8	-	.1250	1/8	1-1/2	1/4	.010
-	-	16912500R.015F	17011	1/8	-	.1250	1/8	1-1/2	1/4	.015
-	-	16912500R.020F	17012	1/8	-	.1250	1/8	1-1/2	1/4	.020

See full line catalog or visit www.maford.com for complete offering.





Series 121

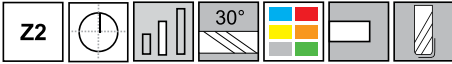

• Designed for aggressive milling of most materials

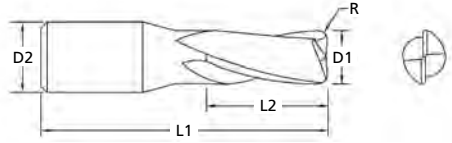

Series 121

TuffCut® GP

2 Flute

MICRO End Mills

Tool No.	EDP	Diameter			Shank		OAL		Flute Length		Corner Radius	
		D1			D2		L1		L2		R	
		Inch	mm	Decimal	Inch	mm	Inch	mm	Inch	mm	Inch	mm
12100500	52101	-	-	.0050	1/8	-	1-1/2	-	.015	-	-	-
12100600	52191	-	-	.0060	1/8	-	1-1/2	-	.018	-	-	-
12100700	52192	-	-	.0070	1/8	-	1-1/2	-	.021	-	-	-
12100780	52102	-	0.2	.0078	-	3.0	-	38	-	0.6	-	-
12100800	52193	-	-	.0080	1/8	-	1-1/2	-	.024	-	-	-
12100900	52194	-	-	.0090	1/8	-	1-1/2	-	.027	-	-	-
12101000	52103	-	-	.0100	1/8	-	1-1/2	-	.030	-	-	-
12101100	52195	-	-	.0110	1/8	-	1-1/2	-	.033	-	-	-
12101180	52104	-	0.3	.0118	-	3.0	-	38	-	0.9	-	-
12101200	52196	-	-	.0120	1/8	-	1-1/2	-	.036	-	-	-
12101300	52197	-	-	.0130	1/8	-	1-1/2	-	.039	-	-	-
12101400	52198	-	-	.0140	1/8	-	1-1/2	-	.042	-	-	-
12101500	52105	-	-	.0150	1/8	-	1-1/2	-	.045	-	-	-
12101560	12106	1/64	-	.0156	1/8	-	1-1/2	-	1/32	-	-	-
12101570	52107	-	0.4	.0157	-	3.0	-	38	-	1.2	-	-
12101600	52199	-	-	.0160	1/8	-	1-1/2	-	.048	-	-	-
12101700	52250	-	-	.0170	1/8	-	1-1/2	-	.051	-	-	-
12101800	52251	-	-	.0180	1/8	-	1-1/2	-	.054	-	-	-
12101900	52252	-	-	.0190	1/8	-	1-1/2	-	.057	-	-	-
12101960	52108	-	0.5	.0196	-	3.0	-	38	-	1.5	-	-
12102000	52109	-	-	.0200	1/8	-	1-1/2	-	.060	-	-	-
12102100	52253	-	-	.0210	1/8	-	1-1/2	-	.063	-	-	-
12102200	52254	-	-	.0220	1/8	-	1-1/2	-	.066	-	-	-
12102300	52255	-	-	.0230	1/8	-	1-1/2	-	.069	-	-	-
12102360	52110	-	0.6	.0236	-	3.0	-	38	-	1.8	-	-
12102400	52256	-	-	.0240	1/8	-	1-1/2	-	.072	-	-	-
12102500	52111	-	-	.0250	1/8	-	1-1/2	-	.075	-	-	-
12102600	52257	-	-	.0260	1/8	-	1-1/2	-	.078	-	-	-
12102700	52258	-	-	.0270	1/8	-	1-1/2	-	.081	-	-	-

Inch	
D1	Tolerance
1/64	+ .000/- .001
1/32 - 1/8	+ .000/- .002

D1 Micro Sizes*	Tolerance
.005 - .100	+ .0005/- .0005

Metric (mm)	
D1	Tolerance (h10)
0.20 - 0.50	+ .000/- .025
0.60 - 3.00	+ .000/- .040

*Inch decimal size range .005 - .100 only.





Series 121 Continued

Tool No.	EDP	Diameter			Shank		OAL		Flute Length		Corner Radius	
		D1			D2		L1		L2		R	
		Inch	mm	Decimal	Inch	mm	Inch	mm	Inch	mm	Inch	mm
12102750	52112	-	0.7	.0275	-	3.0	-	38	-	2.1	-	-
12102800	52259	-	-	.0280	1/8	-	1-1/2	-	.084	-	-	-
12102900	52260	-	-	.0290	1/8	-	1-1/2	-	.087	-	-	-
12103000	52113	-	-	.0300	1/8	-	1-1/2	-	.090	-	-	-
12103120	12114	1/32	-	.0312	1/8	-	1-1/2	-	5/64	-	-	-
12103150	52115	-	0.8	.0315	-	3.0	-	38	-	2.4	-	-
12103500	52116	-	-	.0350	1/8	-	1-1/2	-	.105	-	-	-
12103540	52117	-	0.9	.0354	-	3.0	-	38	-	2.7	-	-
12103940	12118	-	1.0	.0394	-	3.0	-	38	-	3.0	-	-
12104000	52120	-	-	.0400	1/8	-	1-1/2	-	.120	-	-	-
12104330	52121	-	1.1	.0433	-	3.0	-	38	-	3.3	-	-
12104500	52122	-	-	.0450	1/8	-	1-1/2	-	.135	-	-	-
12104680	12123	3/64	-	.0468	1/8	-	1-1/2	-	7/64	-	-	-
12104720	52124	-	1.2	.0472	-	3.0	-	38	-	3.6	-	-
12105000	52125	-	-	.0500	1/8	-	1-1/2	-	.150	-	-	-
12105120	52126	-	1.3	.0512	-	3.0	-	38	-	3.9	-	-
12105500	52127	-	-	.0550	1/8	-	1-1/2	-	.165	-	-	-
12105510	52128	-	1.4	.0551	-	3.0	-	38	-	4.2	-	-
12105910	12129	-	1.5	.0591	-	3.0	-	38	-	6.0	-	-
12105911	52129	-	1.5	.0591	-	3.0	-	38	-	4.5	-	-
12106000	52131	-	-	.0600	1/8	-	1-1/2	-	.180	-	-	-
12106250	12132	1/16	-	.0625	1/8	-	1-1/2	-	3/16	-	-	-
12106300	52133	-	1.6	.0630	-	3.0	-	38	-	4.8	-	-
12106500	52134	-	-	.0650	1/8	-	1-1/2	-	.195	-	-	-
12106690	52135	-	1.7	.0669	-	3.0	-	38	-	5.1	-	-
12107000	52136	-	-	.0700	1/8	-	1-1/2	-	.210	-	-	-
12107090	52137	-	1.8	.0709	-	3.0	-	38	-	5.4	-	-
12107480	52138	-	1.9	.0748	-	3.0	-	38	-	5.7	-	-
12107500	52139	-	-	.0750	1/8	-	1-1/2	-	.225	-	-	-
12107810	12140	5/64	-	.0781	1/8	-	1-1/2	-	3/16	-	-	-
12107870	12141	-	2.0	.0787	-	3.0	-	38	-	9.0	-	-
12107871	52141	-	2.0	.0787	-	3.0	-	38	-	6.0	-	-
12108000	52143	-	-	.0800	1/8	-	1-1/2	-	.240	-	-	-
12108500	52144	-	-	.0850	1/8	-	1-1/2	-	.255	-	-	-
12109000	52145	-	-	.0900	1/8	-	1-1/2	-	.270	-	-	-
12109370	12146	3/32	-	.0937	1/8	-	1-1/2	-	9/32	-	-	-
12109500	52147	-	-	.0950	1/8	-	1-1/2	-	.285	-	-	-
12109840	12148	-	2.5	.0984	-	3.0	-	38	-	12.0	-	-
12110010	52150	-	-	.1000	1/8	-	1-1/2	-	.300	-	-	-
12110930	12151	7/64	-	.1093	1/8	-	1-1/2	-	3/8	-	-	-
12111810	12152	-	3.0	.1181	-	3.0	-	38	-	12.0	-	-





Series 121 Continued

Tool No.	EDP	Diameter			Shank		OAL		Flute Length		Corner Radius	
		D1			D2		L1		L2		R	
		Inch	mm	Decimal	Inch	mm	Inch	mm	Inch	mm	Inch	mm
12111811	52402	-	3.0	.1181	-	3.0	-	38	-	12.0	-	0.500
12112500	12153	1/8	-	.1250	1/8	-	1-1/2	-	3/8	-	-	-
12112511	52401	1/8	-	.1250	1/8	-	1-1/2	-	3/8	-	-	0.015
12112512	52403	1/8	-	.1250	1/8	-	1-1/2	-	3/8	-	-	0.020
12112501	12150	1/8	-	.1250	1/8	-	1-1/2	-	1/2	-	-	-

See full line catalog or visit www.maford.com for complete offering.



Series 121 Coated

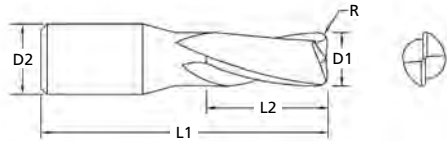

TiN		ALtima®		TiCN		Diameter			Shank		OAL		Flute Length	
Tool No.	EDP	Tool No.	EDP	Tool No.	EDP	D1			D2		L1		L2	
						Inch	mm	Decimal	Inch	mm	Inch	mm	Inch	mm
-	-	12103940A	12119	-	-	-	1.0	.0394	-	3.0	-	38	-	3.0
-	-	12105910A	12130	-	-	-	1.5	.0591	-	3.0	-	38	-	6.0
-	-	12107870A	12142	-	-	-	2.0	.0787	-	3.0	-	38	-	9.0
-	-	12109840A	12147	-	-	-	2.5	.0984	-	3.0	-	38	-	12.0
12111810T	12270	12111810A	52153	12111810C	52154	-	3.0	.1181	-	3.0	-	38	-	12.0
12112500T	12261	12112500A	52155	12112500C	52156	1/8	-	.1250	1/8	-	1-1/2	-	3/8	-

See full line catalog or visit www.maford.com for complete offering.





Series 164

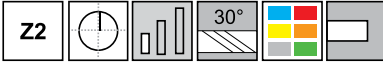

•Designed for aggressive milling of most materials with reduced deflection, improved tool life and overall economy

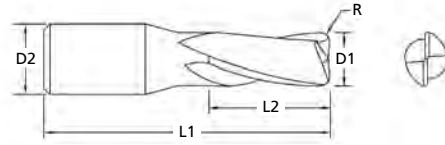

Tool No.	EDP	Diameter			Shank		OAL		Flute Length	
		D1			D2		L1		L2	
		Inch	mm	Decimal	Inch	mm	Inch	mm	Inch	mm
16400500	16468	-	-	.0050	1/8	-	1-1/2	-	.010	-
16400600	16469	-	-	.0060	1/8	-	1-1/2	-	.012	-
16400700	16470	-	-	.0070	1/8	-	1-1/2	-	.014	-
16400780	16402	-	0.2	.0078	-	3.0	-	38	-	0.4
16400800	16471	-	-	.0080	1/8	-	1-1/2	-	.016	-
16400900	16472	-	-	.0090	1/8	-	1-1/2	-	.018	-
16401000	16473	-	-	.0100	1/8	-	1-1/2	-	.020	-
16401100	16474	-	-	.0110	1/8	-	1-1/2	-	.022	-
16401180	16404	-	0.3	.0118	-	3.0	-	38	-	0.6
16401200	16475	-	-	.0120	1/8	-	1-1/2	-	.024	-
16401300	16476	-	-	.0130	1/8	-	1-1/2	-	.026	-
16401400	16477	-	-	.0140	1/8	-	1-1/2	-	.028	-
16401500	16478	-	-	.0150	1/8	-	1-1/2	-	.030	-
16401560	16400	1/64	-	.0156	1/8	-	1-1/2	-	.023	-
16401570	16406	-	0.4	.0157	-	3.0	-	38	-	0.8
16401600	16479	-	-	.0160	1/8	-	1-1/2	-	.032	-
16401700	16480	-	-	.0170	1/8	-	1-1/2	-	.034	-
16401800	16481	-	-	.0180	1/8	-	1-1/2	-	.036	-
16401900	16482	-	-	.0190	1/8	-	1-1/2	-	.038	-
16401960	16408	-	0.5	.0196	-	3.0	-	38	-	1.0
16402000	16483	-	-	.0200	1/8	-	1-1/2	-	.040	-
16402100	16484	-	-	.0210	1/8	-	1-1/2	-	.042	-
16402200	16485	-	-	.0220	1/8	-	1-1/2	-	.044	-
16402300	16486	-	-	.0230	1/8	-	1-1/2	-	.046	-
16402360	16412	-	0.6	.0236	-	3.0	-	38	-	1.2
16402400	16487	-	-	.0240	1/8	-	1-1/2	-	.048	-

Inch	
D1	Tolerance
1/64	+ .000/- .001
1/32 - 1/8	+ .000/- .002

D1 Micro Sizes*	Tolerance
.005 - .060	+ .0005/- .0005

Metric (mm)	
D1	Tolerance (h10)
0.20 - 0.50	+ .000/- .025
0.60 - 3.00	+ .000/- .040

*Inch decimal size range .005 - .060 only.



Page 127



Series 164 Continued

Tool No.	EDP	Diameter			Shank		OAL		Flute Length	
		D1			D2		L1		L2	
		Inch	mm	Decimal	Inch	mm	Inch	mm	Inch	mm
16402500	16488	-	-	.0250	1/8	-	1-1/2	-	.050	-
16402600	16489	-	-	.0260	1/8	-	1-1/2	-	.052	-
16402700	16490	-	-	.0270	1/8	-	1-1/2	-	.054	-
16402750	16414	-	0.7	.0275	-	3.0	-	38	-	1.4
16402800	16491	-	-	.0280	1/8	-	1-1/2	-	.056	-
16402900	16492	-	-	.0290	1/8	-	1-1/2	-	.058	-
16403000	16493	-	-	.0300	1/8	-	1-1/2	-	.060	-
16403100	16572	-	-	.0310	1/8	-	1-1/2	-	.062	-
16403120	16401	1/32	-	.0312	1/8	-	1-1/2	-	1/16	-
16403150	16418	-	0.8	.0315	-	3.0	-	38	-	1.6
16403200	16573	-	-	.0320	1/8	-	1-1/2	-	.064	-
16403300	16574	-	-	.0330	1/8	-	1-1/2	-	.066	-
16403400	16575	-	-	.0340	1/8	-	1-1/2	-	.067	-
16403500	16494	-	-	.0350	1/8	-	1-1/2	-	.070	-
16403540	16420	-	0.9	.0354	-	3.0	-	38	-	1.8
16403600	16576	-	-	.0360	1/8	-	1-1/2	-	.072	-
16403700	16577	-	-	.0370	1/8	-	1-1/2	-	.074	-
16403800	16578	-	-	.0380	1/8	-	1-1/2	-	.076	-
16403900	16579	-	-	.0390	1/8	-	1-1/2	-	.078	-
16403940	16403	-	1.0	.0394	-	3.0	-	38	-	2.0
16404000	16495	-	-	.0400	1/8	-	1-1/2	-	.080	-
16404100	16580	-	-	.0410	1/8	-	1-1/2	-	.082	-
16404200	16581	-	-	.0420	1/8	-	1-1/2	-	.084	-
16404300	16582	-	-	.0430	1/8	-	1-1/2	-	.086	-
16404330	16428	-	1.1	.0433	-	3.0	-	38	-	2.2
16404400	16583	-	-	.0440	1/8	-	1-1/2	-	.088	-
16404500	16496	-	-	.0450	1/8	-	1-1/2	-	.090	-
16404600	16584	-	-	.0460	1/8	-	1-1/2	-	.092	-
16404680	16405	3/64	-	.0468	1/8	-	1-1/2	-	3/32	-
16404700	16585	-	-	.0470	1/8	-	1-1/2	-	.094	-
16404720	16430	-	1.2	.0472	-	3.0	-	38	-	2.4
16404800	16586	-	-	.0480	1/8	-	1-1/2	-	.096	-
16404900	16587	-	-	.0490	1/8	-	1-1/2	-	.098	-
16405000	16497	-	-	.0500	1/8	-	1-1/2	-	.100	-
16405100	16588	-	-	.0510	1/8	-	1-1/2	-	.102	-
16405120	16434	-	1.3	.0512	-	3.0	-	38	-	2.6
16405200	16589	-	-	.0520	1/8	-	1-1/2	-	.104	-
16405300	16590	-	-	.0530	1/8	-	1-1/2	-	.106	-
16405400	16591	-	-	.0540	1/8	-	1-1/2	-	.108	-
16405500	16498	-	-	.0550	1/8	-	1-1/2	-	.110	-
16405510	16438	-	1.4	.0551	-	3.0	-	38	-	2.8

Series 164

TuffCut® GP

2 Flute

MICRO End Mills





Series 164 Continued

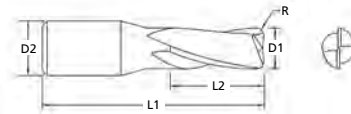

Tool No.	EDP	Diameter			Shank		OAL		Flute Length	
		D1			D2		L1		L2	
		Inch	mm	Decimal	Inch	mm	Inch	mm	Inch	mm
16405600	16592	-	-	.0560	1/8	-	1-1/2	-	.112	-
16405700	16593	-	-	.0570	1/8	-	1-1/2	-	.114	-
16405800	16594	-	-	.0580	1/8	-	1-1/2	-	.116	-
16405900	16595	-	-	.0590	1/8	-	1-1/2	-	.118	-
16405910	16407	-	1.5	.0591	-	3.0	-	38	-	3.0
16406000	16499	-	-	.0600	1/8	-	1-1/2	-	.120	-
16406250	16409	1/16	-	.0625	1/8	-	1-1/2	-	1/8	-
16406300	16444	-	1.6	.0630	-	3.0	-	38	-	3.2
16406690	16446	-	1.7	.0669	-	3.0	-	38	-	3.4
16407090	16448	-	1.8	.0709	-	3.0	-	38	-	3.6
16407480	16450	-	1.9	.0748	-	3.0	-	38	-	3.8
16407810	16410	5/64	-	.0781	1/8	-	1-1/2	-	5/32	-
16407870	16411	-	2.0	.0787	-	3.0	-	38	-	4.0
16409370	16413	3/32	-	.0937	1/8	-	1-1/2	-	3/16	-
16409840	16415	-	2.5	.0984	-	3.0	-	38	-	5.0
16410930	16416	7/64	-	.1093	1/8	-	1-1/2	-	7/32	-
16411810	16417	-	3.0	.1181	-	3.0	-	38	-	6.0
16412500	16419	1/8	-	.1250	1/8	-	1-1/2	-	1/4	-

See full line catalog or visit www.maford.com for complete offering.



Page 127



Series 140

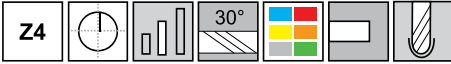

- Manufactured with a full ball radius end. Designed for milling fillets or similar rounded corners in the bottom of a cut
- Ideal for most ferrous metal applications

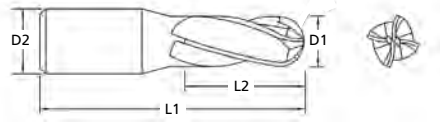

Series 140

TuffCut® GP

MICRO End Mills

4FL Ball

Tool No.	EDP	Diameter			Shank		OAL		Flute Length	
		D1			D2		L1		L2	
		Inch	mm	Decimal	Inch	mm	Inch	mm	Inch	mm
14003120	14001	1/32	-	.0312	1/8	-	1-1/2	-	5/64	-
14003940	14003	-	1.0	.0394	-	3.0	-	38	-	3.0
14004680	14005	3/64	-	.0468	1/8	-	1-1/2	-	7/64	-
14005910	14007	-	1.5	.0591	-	3.0	-	38	-	6.0
14006250	14009	1/16	-	.0625	1/8	-	1-1/2	-	3/16	-
14007810	14011	5/64	-	.0781	1/8	-	1-1/2	-	3/16	-
14007870	14013	-	2.0	.0787	-	3.0	-	38	-	9.0
14009370	14015	3/32	-	.0937	1/8	-	1-1/2	-	9/32	-
14009840	14017	-	2.5	.0984	-	3.0	-	38	-	12.0
14010930	14021	7/64	-	.1093	1/8	-	1-1/2	-	3/8	-
14011810	14023	-	3.0	.1181	-	3.0	-	38	-	12.0
14012500	14025	1/8	-	.1250	1/8	-	1-1/2	-	3/8	-

Inch	
D1	Tolerance
1/32 - 1/8	+0.000/-0.002

Metric (mm)	
D1	Tolerance (h10)
1.00 - 3.00	+0.000/-0.040

Inch	
R	Tolerance
<1/16	+0.001/-0.001
>1/16 - 1/8	+0.002/-0.002

Metric (mm)	
R	Tolerance
<1.5	+0.025/-0.025
1.6 - 3.0	+0.050/-0.050

See full line catalog or visit www.maford.com for complete offering.





Series 140 Coated

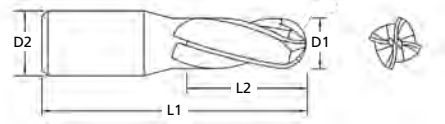
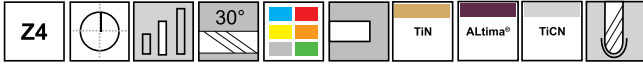

TiN		ALtima®		TiCN		Diameter			Shank		OAL		Flute Length	
Tool No.	EDP	Tool No.	EDP	Tool No.	EDP	D1			D2		L1		L2	
						Inch	mm	Decimal	Inch	mm	Inch	mm	Inch	mm
-	-	14003940A	14108	-	-	-	1.0	.0394	-	3.0	-	38	-	3.0
-	-	14005910A	14109	-	-	-	1.5	.0591	-	3.0	-	38	-	6.0
-	-	14007870A	14110	-	-	-	2.0	.0787	-	3.0	-	38	-	9.0
-	-	14009840A	14111	-	-	-	2.5	.0984	-	3.0	-	38	-	12.0
14011810T	14072	14011810A	14000	14011810C	14036	-	3.0	.1181	-	3.0	-	38	-	12.0
14012500T	14074	14012500A	14002	14012500C	14038	1/8	-	.1250	1/8	-	1-1/2	-	3/8	-

See full line catalog or visit www.maford.com for complete offering.





Series 165

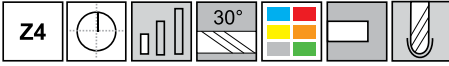

- Manufactured with full ball radius end
- Ideal for most ferrous metal applications

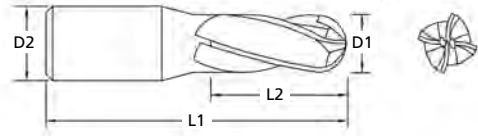

Series 165

TuffCut® GP

MICRO End Mills

4FL Ball

Tool No.	EDP	Diameter			Shank		OAL		Flute Length	
		D1			D2		L1		L2	
		Inch	mm	Decimal	Inch	mm	Inch	mm	Inch	mm
16501560	16500	1/64	-	.0156	1/8	-	1-1/2	-	.023	-
16503120	16501	1/32	-	.0312	1/8	-	1-1/2	-	1/16	-
16503940	16503	-	1.0	.0394	-	3.0	-	38	-	2.0
16504680	16505	3/64	-	.0468	1/8	-	1-1/2	-	3/32	-
16505910	16507	-	1.5	.0591	-	3.0	-	38	-	3.0
16506250	16509	1/16	-	.0625	1/8	-	1-1/2	-	1/8	-
16507810	16510	5/64	-	.0781	1/8	-	1-1/2	-	5/32	-
16507870	16511	-	2.0	.0787	-	3.0	-	38	-	4.0
16509370	16513	3/32	--	.0937	1/8	-	1-1/2	-	3/16	-
16509840	16515	--	2.5	.0984	-	3.0	-	38	-	5.0
16510930	16516	7/64	-	.1093	1/8	-	1-1/2	-	7/32	-
16511810	16517	-	3.0	.1181	-	3.0	-	38	-	6.0
16512500	16519	1/8	-	.1250	1/8	--	1-1/2	-	1/4	-

Inch	
D1	Tolerance
1/64	+ .000/- .001
1/32 - 1/8	+ .000/- .002

Metric (mm)	
D1	Tolerance (h10)
1.00 - 3.00	+ .000/- .040

Inch	
R	Tolerance
≤ 1/16	+ .001/- .001
> 1/16 - 1/8	+ .002/- .002

Metric (mm)	
R	Tolerance
≤ 1.5	+ .025/- .025
1.6 - 3.0	+ .050/- .050

See full line catalog or visit www.mafor.com for complete offering.





Series 150

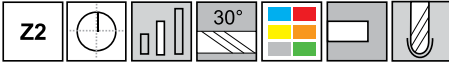

- Manufactured with a full ball radius end. Designed for milling fillets or similar rounded corners in the bottom of a cut. Ideal for most ferrous metal applications.

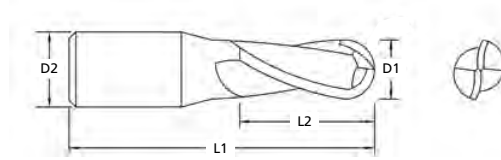

Tool No.	EDP	Diameter			Shank		OAL		Flute Length	
		D1			D2		L1		L2	
		Inch	mm	Decimal	Inch	mm	Inch	mm	Inch	mm
15001500	15002	-	-	.0150	1/8	-	1-1/2	-	.045	-
15001570	15038	-	0.4	.0157	-	3	-	38	-	1.2
15001960	15040	-	0.5	.0196	-	3	-	38	-	1.5
15002000	15004	-	-	.0200	1/8	-	1-1/2	-	.060	-
15002360	15042	-	0.6	.0236	-	3	-	38	-	1.8
15002500	15006	-	-	.0250	1/8	-	1-1/2	-	.075	-
15002750	15044	-	0.7	.0275	-	3	-	38	-	2.1
15003000	15008	-	-	.0300	1/8	-	1-1/2	-	.090	-
15003120	15001	1/32	-	.0312	1/8	-	1-1/2	-	5/64	-
15003150	15046	-	0.8	.0315	-	3	-	38	-	2.4
15003500	15010	-	-	.0350	1/8	-	1-1/2	-	.105	-
15003540	15048	-	0.9	.0354	-	3	-	38	-	2.7
15003940	15003	-	1.0	.0394	-	3	-	38	-	3.0
15004000	15012	-	-	.0400	1/8	-	1-1/2	-	.120	-
15004330	15052	-	1.1	.0433	-	3	-	38	-	3.3
15004500	15014	-	-	.0450	1/8	-	1-1/2	-	.135	-
15004680	15005	3/64	-	.0468	1/8	-	1-1/2	-	7/64	-
15004720	15054	-	1.2	.0472	-	3	-	38	-	3.6
15005000	15016	-	-	.0500	1/8	-	1-1/2	-	.150	-
15005120	15056	-	1.3	.0512	-	3	-	38	-	3.9
15005500	15018	-	-	.0550	1/8	-	1-1/2	-	.165	-
15005510	15058	-	1.4	.0551	-	3	-	38	-	4.2

Inch	
D1	Tolerance
1/32 - 1/8	+ .000/- .002

D1 Micro Sizes*		Tolerance
.015 - .100		+ .0005/- .0005

Metric (mm)	
D1	Tolerance (h10)
0.40 - 0.50	+ .000/- .025
0.60 - 3.00	+ .000/- .040

*Inch decimal size range .015 - .100 only.



Page 125

Inch	
R	Tolerance
≤ 1/16	+ .001/- .001
> 1/16 - 1/8	+ .002/- .002

Metric (mm)	
R	Tolerance
≤ 1.5	+ .025/- .025
1.6 - 3.0	+ .050/- .050



Series 150 Continued

Tool No.	EDP	Diameter			Shank		OAL		Flute Length	
		D1			D2		L1		L2	
		Inch	mm	Decimal	Inch	mm	Inch	mm	Inch	mm
15005910	15007	-	1.5	.0591	-	3	-	38	-	6.0
15005911	15060	-	1.5	.0591	-	3	-	38	-	4.5
15006000	15020	-	-	.0600	1/8	-	1-1/2	-	.180	-
15006250	15009	1/16	-	.0625	1/8	-	1-1/2	-	3/16	-
15006300	15062	-	1.6	.0630	-	3	-	38	-	4.8
15006500	15022	-	-	.0650	1/8	-	1-1/2	-	.195	-
15006690	15064	-	1.7	.0669	-	3	-	38	-	5.1
15007000	15024	-	-	.0700	1/8	-	1-1/2	-	.210	-
15007090	15066	-	1.8	.0709	-	3	-	38	-	5.4
15007480	15068	-	1.9	.0748	-	3	-	38	-	5.7
15007500	15026	-	-	.0750	1/8	-	1-1/2	-	.225	-
15007810	15011	5/64	-	.0781	1/8	-	1-1/2	-	3/16	-
15007870	15013	-	2.0	.0787	-	3	-	38	-	9.0
15007871	15070	-	2.0	.0787	-	3	-	38	-	6.0
15008000	15028	-	-	.0800	1/8	-	1-1/2	-	.240	-
15008500	15030	-	-	.0850	1/8	-	1-1/2	-	.255	-
15009000	15032	-	-	.0900	1/8	-	1-1/2	-	.270	-
15009370	15015	3/32	-	.0937	1/8	-	1-1/2	-	9/32	-
15009500	15034	-	-	.0950	1/8	-	1-1/2	-	.285	-
15009840	15017	-	2.5	.0984	-	3	-	38	-	12.0
15010010	15036	-	-	.1000	1/8	-	1-1/2	-	.300	-
15010930	15021	7/64	-	.1093	1/8	-	1-1/2	-	3/8	-
15011810	15023	-	3.0	.1181	-	3	-	38	--	12.0
15012500	15025	1/8	-	.1250	1/8	-	1-1/2	-	3/8	-

See full line catalog or visit www.maford.com for complete offering.





Series 150 Coated

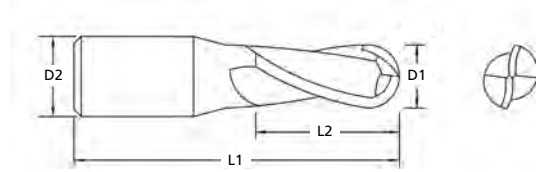
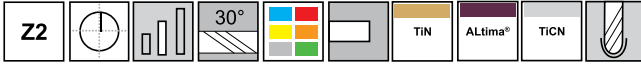

TiN		ALtima®		TiCN		Diameter			Shank		OAL		Flute Length	
Tool No.	EDP	Tool No.	EDP	Tool No.	EDP	D1			D2		L1		L2	
						Inch	mm	Decimal	Inch	mm	Inch	mm	Inch	mm
-	-	15003940A	15050	-	-	-	1.0	.0394	-	3.0	-	38	-	3.0
-	-	15005910A	15080	-	-	-	1.5	.0591	-	3.0	-	38	-	6.0
-	-	15007870A	15082	-	-	-	2.0	.0787	-	3.0	-	38	-	9.0
-	-	15009840A	15084	-	-	-	2.5	.0984	-	3.0	-	38	-	12.0
15011810T	55076	15011810A	55040	15011810C	55058	-	3.0	.1181	-	3.0	-	38	-	12.0
15012500T	55077	15012500A	55041	15012500C	55059	1/8	-	.1250	1/8	-	1-1/2	-	3/8	-

See full line catalog or visit www.maford.com for complete offering.





Series 166

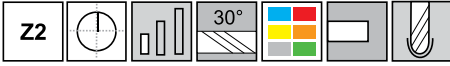

- Manufactured with a full ball radius end. Designed for milling fillets or similar rounded corners in the bottom of a cut.
- Ideal for most ferrous metal applications.

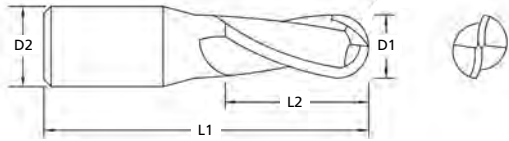

Series 166

TuffCut® GP

MICRO End Mills

2 FL Ball

Tool No.	EDP	Diameter			Shank		OAL		Flute Length	
		D1			D2		L1		L2	
		Inch	mm	Decimal	Inch	mm	Inch	mm	Inch	mm
16601560	16600	1/64	-	.0156	1/8	-	1-1/2	-	.023	-
16603120	16601	1/32	-	.0312	1/8	-	1-1/2	-	1/16	-
16603940	16603	-	1.0	.0394	-	3.0	-	38	-	2.0
16604680	16605	3/64	-	.0468	1/8	-	1-1/2	-	3/32	-
16605910	16607	-	1.5	.0591	-	3.0	-	38	-	3.0
16606250	16609	1/16	-	.0625	1/8	-	1-1/2	-	1/8	-
16607810	16610	5/64	-	.0781	1/8	-	1-1/2	-	5/32	-
16607870	16611	-	2.0	.0787	-	3.0	-	38	-	4.0
16609370	16613	3/32	-	.0937	1/8	-	1-1/2	-	3/16	-
16609840	16615	-	2.5	.0984	-	3.0	-	38	-	5.0
16610930	16616	7/64	-	.1093	1/8	-	1-1/2	-	7/32	-
16611810	16617	-	3.0	.1181	-	3.0	-	38	-	6.0
16612500	16619	1/8	-	.1250	1/8	-	1-1/2	-	1/4	-

Inch	
D1	Tolerance
1/64	+ .000/- .001
1/32 - 1/8	+ .000/- .002

Metric (mm)	
D1	Tolerance (h10)
1.00 - 3.00	+ .000/- .040

Inch	
R	Tolerance
<1/16	+ .001/- .001
>1/16 - 1/8	+ .002/- .002

Metric (mm)	
R	Tolerance
<1.5	+ .025/- .025
1.6 - 3.0	+ .050/- .050



Page 127

See full line catalog or visit www.maford.com for complete offering.

TuffCut® XT & XR

Features

- Unique M.A. Ford® Heli-Pitch Geometry.
- Proprietary Carbide Substrate.
- Improved Geometries.
- Enhanced Corner Protection.
- Industry Standard Corner Radius.
- ALtima®, ALtima® Blaze and ALtima® Xtreme coated.
- 4, 5, 7 and 9 Flutes.
- Stub, Standard, Long and Extra Long Lengths, as well as neck relief styles available.
- Size range 1/16" - 1" and 1.5mm - 25mm.
- Whisper Blend Transition between OD and Neck.

Benefits

- Higher Feeds Over Similar End Mills.
- Reduced Vibration Harmonics.
- Improved Part Finishes.
- Slotting at 1X Diameter Deep.
- Maintains Cutting Edge Strength & Sharpness for Improved Tool Life.
- State-Of-The-Art ALtima® & ALtima® Blaze PVD Coating for Superior Tool Life.
- For Titanium and High Temp Alloy Applications.



TuffCut® AL & X-AL

Features

- 2 and 3 flute end mills, center cutting.
- Multiple lengths, necked options.
- Square end, corner radius, ball, and chipbreaker versions.
- Uncoated or Fordlube coating.
- Wiper flat end geometry with face grind protection.
- Size range 1/8" - 1" and 2.0mm - 25.0mm.

Benefits

- For roughing and finishing applications.
- Extremely high chip loads.
- Improved chip flow prevents packing in flutes.
- Superior floor finishes on customer parts.



See full line catalog or visit www.maford.com for complete offering.



TuffCut®

End Mill Icon Glossary

Technical Information

MICRO End Mills

Workpiece Material Group

	Number of Flutes		
	Center Cutting		Steels
	Length		Stainless Steels
	Helix Angle		Cast Iron
	Ball Nose		Special Alloys
	Neck Relief		Hardened Steels (35-65Rc)
	Corner Radius		Non-Ferrous
	Shank		
	Shank/DIN		
	Chipbreaker		

Coatings

	Maximum Coolant
	Minimal Coolant

Cutting Calculations and Definitions		Metric	U.S.
ae	= Width of cut, radial depth of cut	(mm)	(inch)
ap	= Depth of cut, axial depth of cut	(mm)	(inch)
Dc	= Cutter diameter	(mm)	(inch)
f	= Feed per revolution	(mm/rev)	(IPR)
fz	= Feed per tooth	(mm/tooth)	(IPT)
zn	= Number of teeth	Number	
n	= RPM	(rev/min)	(rev/min)
Q	= Metal removal rate	(cm ³ /min)	(in ³ /min)
vc	= Cutting speed	(m/min)	(SFM)
vf	= Feed speed	(mm/min)	(IPM)
Dw	= Working diameter	(mm)	(inch)

Formulas

Inch

RPM (n) = SFM (vc) x 3.82/Tool Diam.
IPM (vf) = RPM (n) x IPR (f)

Conversion Inch to Metric

SFM (vc) to m/min (vc) = SFM (vc) x .3048
IPM (vf) to mm/min (vf) = IPM (vf) x 25.4

Metric

RPM (n) = m/min (vc) x 318.057/Tool Diam.
mm/min (vf) = RPM (n) x mm/Revolution (f).

Conversion Metric to Inch

m/min (vc) to SFM (vc) = (m/min)/.3048
mm/min (vf) to IPM (vf) = (mm/min)/25.4

Safety Note

Always wear the appropriate personal protective equipment such as safety glasses and protective clothing when using solid carbide or HSS cutting tools. Machines should be fully guarded.

Technical data provided should be considered advisory only as variations may be necessary depending on the particular application.



End Mill Troubleshooting

PROBLEM	POSSIBLE CAUSE	POSSIBLE SOLUTION
Excessive Flank Wear	Speed too high	Reduce the cutting speed RPM's (n).
	Improper feed speed (too slow)	Increase feed per tooth (fz).
	Hard workpiece material > 55 Rc	Try 90-100 SFM (vc) with multi-fluted tool (5 flutes+). Use ALtima® 52 hard coating.
	Recutting Chips	Change feed speed to change chip size or clear chips with coolant or air pressure.
	Milling Strategy	Ensure you are climb milling unless workpiece material has hard/abrasive outer skin or high impact tool steel like D2, then conventional milling technique is preferred for breakthrough. (see pg 108).
	Improper cutting angle	Change to correct cutting angle, tilt tool at 15 degrees.
	Too low a primary relief angle	Change to larger relief angle.
PROBLEM	POSSIBLE CAUSE	POSSIBLE SOLUTION
Excessive Corner Wear	No Corner Radius	Implementing corner radius on tool adds strength and increases tool life.
	Speed too high	Reduce the cutting speed RPM's (n).
	Tool Runout	Check tool runout in holder/spindle, <.0003" (.0076mm) desired. Hand ground flats can be suspect and common cause. Use collet, milling chuck, or shrink fit holders if possible.
	Tool Overhang	Ensure you are using shortest OAL possible, stub tool in holder. Utilize stronger necked tool for longer reaches.
PROBLEM	POSSIBLE CAUSE	POSSIBLE SOLUTION
Cutting Edge Chipping	Lack of rigidity (tool)	Use shortest end mill available, hold shank deeper in holder, investigate for tool slippage. Use short gage length holder.
	Lack of rigidity (workpiece)	Tighten workpiece fixture - a common problem.
	Feed too high	Decrease feed per tooth (fz).
	Feed to high on first pass	Decrease feed per tooth (fz) on first pass through workpiece skin or reduce radial width of cut (ae) first pass.
	Part Entry	Reduce FPT on entry - implement radius in or sweeping entrances - avoid 90° (perpendicular) entry.
	Milling Strategy	Ensure you are climb milling unless workpiece material has hard/abrasive outer skin or high impact tool steel like D2, then conventional milling technique is preferred for breakthrough. (see pg 108).
	Tool Overhang	Ensure you are using shortest OAL possible, stub tool in holder. Utilize stronger necked tool for longer reaches.
	Tool Runout	Check tool runout in holder/spindle, <.0003" (.0076mm) desired. Hand ground flats can be suspect and common cause. Use collet, milling chuck, or shrink fit holders if possible.
	Not enough rigidity of machine tool & holder	Change rigid machine tool or holder.
	Cutting Edge Prep	Ensure tool has proper edge prep for workpiece material.
	Teeth too sharp	Change to lower cutting angle, primary relief.

Technical data provided should be considered advisory only as variations may be necessary depending on the particular application.



End Mill Troubleshooting Continued

PROBLEM	POSSIBLE CAUSE	POSSIBLE SOLUTION
Breakage	Lack of rigidity (workpiece)	Tighten workpiece fixture - a common problem.
	Speed too low	Increase the cutting speed RPM's (n).
	Feed too high	Decrease feed per tooth (fz).
	Heavy depth of cut	Reduce width of cut, radial depth of cut (ae) & depth of cut, axial depth of cut (ap).
	Part Entry	Reduce FPT on entry - implement radius in or sweeping entrances - avoid 90° (perpendicular) entry.
	Milling Strategy	Review tool path and ensure there are no arbitrary moves, extreme arc of engagement increases & undesirable situations for the tool. Keep constant radial engagement. See tool path diagrams on page 110.
	Tool Overhang	Ensure you are using shortest OAL possible, stub tool in holder. Utilize stronger necked tool for longer reaches.
	Tool Runout	Check tool runout in holder/spindle, <.0003" (.0076mm) desired. Hand ground flats can be suspect and common cause. Use collet, milling chuck, or shrink fit holders if possible.
	Excessive edge wear	Recondition at earlier stage. Factory recondition service is recommended. See M.A. Ford's® Redbox reconditioning program on page 111.
PROBLEM	POSSIBLE CAUSE	POSSIBLE SOLUTION
Built Up Edge (BUE)	Chip Welding to cutting edge	Utilize proper tool coating for workpiece material being cut. Climb mill preferred.
	Feed too low	Increase feed per tooth (fz).
	Speed too low	Increase the cutting speed RPM's (n).
	Coolant Strategy	Add coolant or readjust coolant flow, use through tool coolant if available. Check coolant mixture concentration.
PROBLEM	POSSIBLE CAUSE	POSSIBLE SOLUTION
Chip Packing	Insufficient chip room	Use end mill with fewer flutes.
	Feed too high	Decrease feed per tooth (fz).
	Heavy depth of cut	Reduce width of cut, radial depth of cut (ae) & depth of cut, axial depth of cut (ap).
	Not enough coolant	Apply more coolant to flush chips. Use air pressure or op. stop to clear chips away.
	Large heavy chip	Utilize chipbreaker style tool to cut chip size.
PROBLEM	POSSIBLE CAUSE	POSSIBLE SOLUTION
Poor Surface Finish	Feed too high	Decrease feed per tooth (fz).
	Speed too low	Increase the cutting speed RPM's (n).
	Too light width of cut	Increase width of cut, radial depth of cut (ae) to stabilize tool in cut.
	Tool Runout	Check tool runout in holder/spindle, <.0003" (.0076mm) desired. Hand ground flats can be suspect and common cause. Use collet, milling chuck, or shrink fit holders if possible.
	Built up Edge	Use Flood Coolant.
	Recutting Chips	Redirect/Evaluate coolant flush - or use fewer number of flutes.
	No end tooth concavity	Add margin (touch primary with oilstone).

Technical data provided should be considered advisory only as variations may be necessary depending on the particular application.





End Mill Troubleshooting Continued

PROBLEM	POSSIBLE CAUSE	POSSIBLE SOLUTION
Chatter/Vibration	Lack of rigidity (workpiece)	Tighten workpiece fixture - a common problem.
	Lack of rigidity (machine & holder)	Use better machine tool, holder or change condition. Ask your M.A. Ford® representative about BlueSwarf harmonic testing.
	Tool Runout	Check tool runout in holder/spindle, <.0003" (.0076mm) desired. Hand ground flats can be suspect and common cause. Use collet, milling chuck, or shrink fit holders if possible.
	Speed too high	Reduce the cutting speed RPM's (n).
	Feed too low	Increase feed per tooth (fz).
	Chip too thin	Utilize chip thinning adjustment multiplier.
	Arc of engagement violation	Use smaller tools and generate corner radii in pockets. Avoid tools that diameter matches workpiece corner radius, or rough plunge corners.
	Milling Strategy	Ensure you are climb milling unless workpiece material has hard/abrasive outer skin or high impact tool steel like D2 then conventional milling technique is preferred for breakthrough.
PROBLEM	POSSIBLE CAUSE	POSSIBLE SOLUTION
Tool Deflection	Tool Overhang	Ensure you are using shortest OAL possible, stub tool in holder. Utilize stronger necked tool for longer reaches.
	End mill Diameter	Increase diameter of end mill for higher strength to length ratio.
	Increase number of flutes	Higher number of flutes = larger core diameter = increased strength.
	Feed too high	Decrease feed per tooth (fz).
	Too high width of cut	Decrease width of cut, radial depth of cut (ae).
	Milling Strategy	Climb milling can help reduce the amount of deflection in some cases.
PROBLEM	POSSIBLE CAUSE	POSSIBLE SOLUTION
No Dimensional Accuracy (Wall Tapered)	Coolant Strategy	Add coolant or readjust coolant flow, use through tool coolant if available. Check coolant mixture concentration.
	Tool Deflection	See Tool Deflection above.
	Feed too high	Decrease feed per tooth (fz).
	Too high width of cut	Decrease width of cut, radial depth of cut (ae).
	Tool Runout	Check tool runout in holder/spindle, <.0003" (.0076mm) desired. Hand ground flats can be suspect and common cause. Use collet, milling chuck, or shrink fit holders if possible.

Technical data provided should be considered advisory only as variations may be necessary depending on the particular application.



Milling Strategy Comparison

Conventional Machining

- Reduced Axial Depths Of Cut (ap) - Normally 1 x Tool Diameter
- Higher Radial Depths Of Cut (ae) - Normally 0.5 x Tool Diameter
- Lower Spindle Speed RPM (n)
- Lower Feed Rate (vf) (inch/min or mm/min)
- Slower Machining Time
- Low Metal Removal Rate (Q - in³/min or cm³/min)

High Speed Machining (HSM)

- Increased Axial Depths Of Cut (ap) - up to 2 x Tool Diameter
- Reduced Radial Depths Of Cut (ae) - 0.1/0.2 x Tool Diameter
- Higher Spindle Speed RPM (n)
- Higher Feed Rate (vf) (inch/min or mm/min)
- Faster Machining Time
- High Metal Removal Rate (Q - in³/min or cm³/min)

Conventional

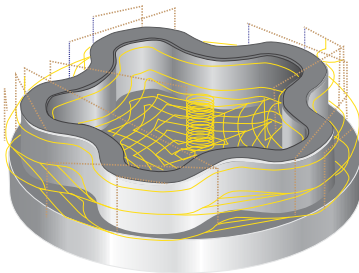

High Speed

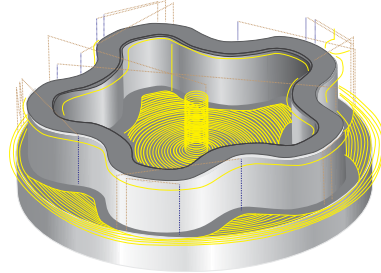

Tool Ø 12.0mm (.4724") 4 Flute

vc - 150m/min (5,905 in/min)
n - 3,975 RPM

fz - 0.06mm/z (.0024 in/z)
vf - 954mm/min (37.6 in/min)

ap - 2 x 12.0mm (.4724") 1xD
ae - 6.0mm (.2362") 0.5xD

Metal Removal Rate (MRR)
68.7 cm³/min (4.2 in³/min)

Machining Time
7 minutes 45 Seconds

Tool Ø 12.0mm (.4724") 5 Flute

vc - 300m/min (11,811 in/min)
n - 8,000 RPM

fz - 0.15mm/z (.006 in/z)
vf - 6,000mm/min (240 in/min)

ap - 24.0mm (.945") 2xD
ae - 1.2mm (.047") 0.1xD

Metal Removal Rate (MRR)
172.8 cm³/min (10.5 in³/min)

Machining Time
3 minutes 35 Seconds

Contact Your Local M.A. Ford® Representative For More Information On The Right Milling Strategy For Your Application.

Technical data provided should be considered advisory only as variations may be necessary depending on the particular application.



Radial Chip Thinning

During profile or side milling with a solid carbide end mill at 50% (a_e) radial width of cut, the chip formed is at full programmed thickness. When your radial depth of cut decreases to something less than 50%, the chip formed is not as thick. This is known as “radial chip thinning”. When less than 50% (a_e) radial depths are used, it becomes necessary to increase your feed to achieve full chip thickness. This means a higher programmed feed rate is needed to achieve the recommended chip thickness.

Programmers and Machinists have a tendency to lower feed rate due to previous experience. With the utilization of new programming methods, such as trochoidal and peel milling, manufacturers can increase productivity and tool life. These methods take advantage of much deeper (a_p) axial cuts with less (a_e) radial width of cut. With these methods, it’s possible to run higher surface footages (SFM or m/min) along with these higher feed rates (IPM or mm/min) because less heat is generated at the cutting zone. Plus, you’re utilizing chip thinning.

With the introduction of M.A.Ford®’s variable pitch tools, harmonics have virtually been eliminated, thus easing Programmers and Machinists fears of previous experiences. Advancements in our hard coatings enable our tools to withstand 900 degrees F, thus eliminating heat concerns. In addition, machine tools have advanced greatly to take advantage of these new methods.

Use the following chart as a reference to increase feed rates by multiplying recommended feed rate by the increase feed factor, according to your (a_e) radial depth of cut as % of (D_c) cutter diameter.

(a_e) Radial Depth of Cut as to % of (D_c) Cutter Diameter	Increase Feed Factor
30%	1.10
25%	1.20
20%	1.20
15%	1.41
10%	1.80
7%	2.00
5%	2.30
3%	2.93
2%	3.60
1%	5.00

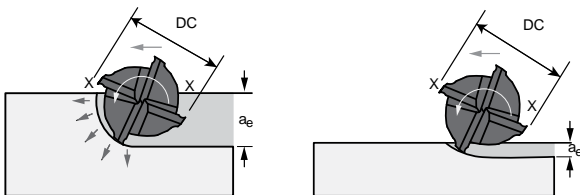

Technical data provided should be considered advisory only as variations may be necessary depending on the particular application.



Tool Engagement Angle

Sometimes referred to as "Arc of Engagement", this is the degrees of engagement the end mill will contact the part during cut depths in the radial direction. Ideally you would like to engage the end mill at a constant engagement angle of 30-40 degrees. At this degree of engagement the tool will perform best because of acceptable loading while not exceeding deflection limits.

As the tool travels around the geometrical shape of the part features, it will encounter areas where it could exceed the acceptable engagement angle. Software manufacturers have created methods to calculate algorithms to avoid these situations. One such case would be the entry into a pocket corner. At 50% radial depth of cut (a_e), the cutter runs along the pocket side with a tool engagement angle of 90 degrees. As it enters the corner, it can quickly jump to 180 degrees as shown in the example below.

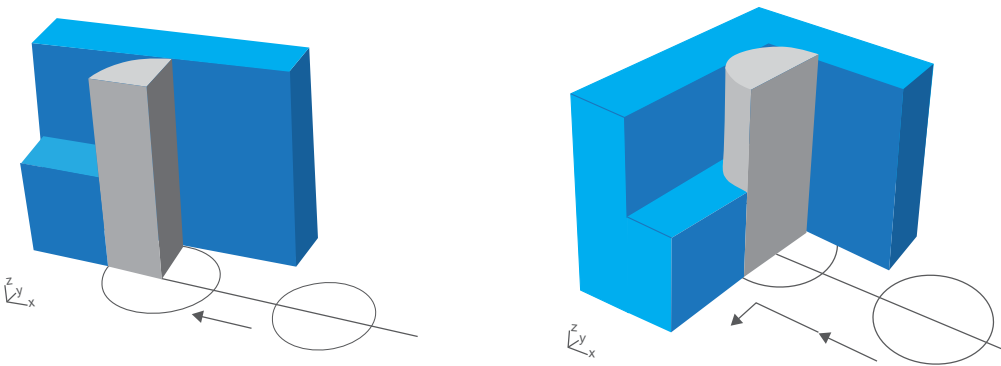

At this intersection, large engagement would cause tool chatter and even breakage. Using CAD CAM software to generate the corner avoids an abrupt stop and change of direction. It also keeps a constant arc of engagement while providing smooth chatter free cutting and long tool life.

Contact Your Local M.A. Ford® Representative For More Information On The Right Milling Strategy For Your Application.

Technical data provided should be considered advisory only as variations may be necessary depending on the particular application.



Deflection

During the machining process, high cutting forces are directed on the end mill causing it to deflect. How much the end mill deflects depends on cutting parameters, tool diameter, tool stick out, and the elasticity coefficient (PSI) of the cutting tool material. The cutting tool strength will vary from different suppliers. At M.A.Ford®, we use only raw material of the highest quality and strength.

During roughing, deflection can be slightly higher than finishing. Deflection may be tolerable when roughing because at some point you will come back and finish cut your part. On larger carbide tools, deflection less than .001" (.025mm) is acceptable. However, on small micro end mills, deflection of less than .0005" (.0127mm) is acceptable.

Depending whether you are conventional milling or climb milling, deflection will be in different directions. With climb milling, deflection is in the direct opposite of the cut, but with conventional milling its direction is more parallel with the cut. This difference in direction will impart a different pattern finish on the wall of the workpiece. In climb milling, the tool engagement lines are more vertical and distinct. With conventional milling, your chip starts out thin and then gets thicker as your end mill continues through the cut; tool engagement lines are not as distinctly vertical.

M.A.Ford® has designed computer software to perform the many calculations required to determine tool deflection. All M.A.Ford® tools carry a Lot Number which can be traced back to that tool's DNA. With this information, we can plug the exact carbide TRS number into our software. How does this benefit you? We can increase cutting parameters to the point of maximum deflection, thus optimizing your operation parameters.

Please contact M.A.Ford's Tech Line (1-800-553-8024 or maftech@maford.com) with your tooling application questions.

RED BOX

Factory Reconditioning Service

Extend the life of your cutting tools with M.A. Ford's
Factory Reconditioning / Recoating Service.



SAVE and Go Green



**Drills
End Mills
Countersinks
Burs**

Simplified Pricing Structure.
No Minimum Order Value.
Original Coatings.

M.A. Ford® Quality Workmanship.
Tools Reground to Factory Specifications.
Quick Turnaround.

RETURN • RECONDITION • REDUCE COST

www.maford.com for details. 800-553-8024 • 563-391-6220

Technical data provided should be considered advisory only as variations may be necessary depending on the particular application.



Pocket Corners

Inside or pocket corners present a different challenge in two ways. First, if the corner radius is proportionally smaller than the related pocket size, it is necessary to use a much smaller diameter end mill to achieve the necessary radius. With a small diameter end mill there are restrictions from a cut depth standpoint; a small end mill will deflect when axial depth of cut (a_p) exceeds the end mills limits and breakage can occur.

Secondly, to rough the pocket the programmer may use a much larger end mill to remove large amounts of stock. If you plow into the rough corner with the small end mill, your tool engagement angle can cause the small end mill to deflect and chip or break. To avoid these problems, you must use one of two methods: peck milling or rest milling. Software packages again ease this procedure by maintaining low tool engagement angle.

Peck milling is a series of axial plunge moves to remove much of the stock remaining in the corner. Plunging directs forces axially on the machine spindle, thus eliminating radial force and deflection. This is particularly beneficial for light duty machines.

Rest milling is a series of circular moves while traveling in the Z direction, very similar to helical milling. This removes the remaining stock much like trochoidal milling but with the addition of Z movements.

Peck Milling

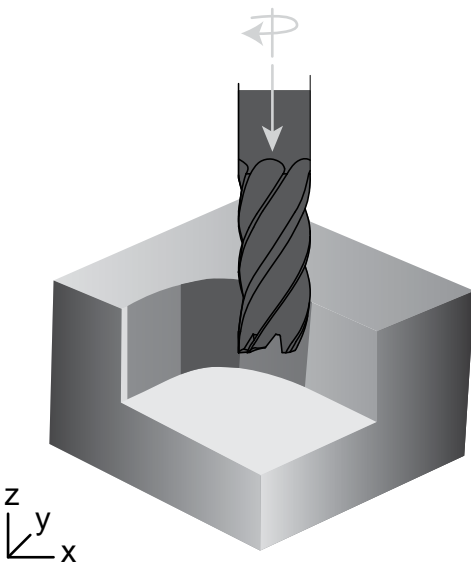

Rest Milling

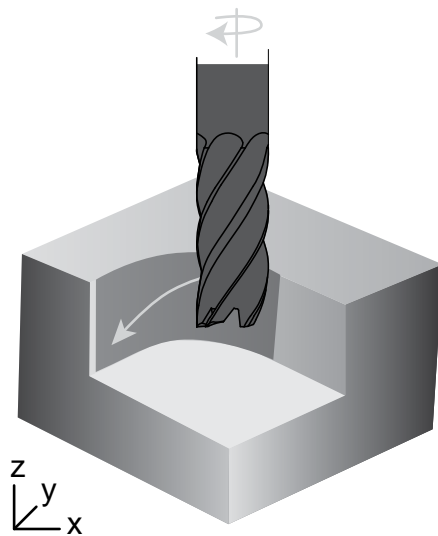

Technical data provided should be considered advisory only as variations may be necessary depending on the particular application.



3MV Series Recommended Cutting Data - Inch

Stub Flute Length Tools (3MVS)

Workpiece Material Group	ISO	Coolant ● Preferred ○ Possible X Not Possible			Application	Depth of Cut Per Application		Vc SFM	fz - in/tooth By Cutter Diameter							
		Max.	Air	MMS		Radial (Ae)	Axial (Ap)		0.015	0.031	0.047	0.062	0.078	0.093	0.109	0.125
Moderate Machining & PH Stainless Steels	M	●	X	○	Slotting	-	.5 x D	245	.00004	.00007	.00011	.00015	.00019	.00022	.00026	.00030
					Profiling	.2 x D	1 x D	490	.00010	.00020	.00031	.00041	.00051	.00061	.00072	.00083
High Temp Alloys	S	●	X	X	Slotting	-	.5 x D	100	.00003	.00006	.00009	.00012	.00016	.00019	.00022	.00025
					Profiling	.1 x D	1 x D	150	.00008	.00017	.00026	.00035	.00044	.00052	.00061	.00070
Titanium Alloys	S	●	X	X	Slotting	-	.5 x D	245	.00004	.00007	.00011	.00015	.00019	.00022	.00026	.00030
					Profiling	.2 x D	1 x D	350	.00006	.00012	.00019	.00025	.00031	.00037	.00044	.00050

Please Note: Square corner tools recommended for finishing applications only.

Regular Flute Length Tools (3MVR)

Workpiece Material Group	ISO	Coolant ● Preferred ○ Possible X Not Possible			Application	Depth of Cut Per Application		Vc SFM	fz - in/tooth By Cutter Diameter							
		Max.	Air	MMS		Radial (Ae)	Axial (Ap)		0.015	0.031	0.047	0.062	0.078	0.093	0.109	0.125
Moderate Machining & PH Stainless Steels	M	●	X	○	Slotting	-	.5 x D	245	.00004	.00007	.00011	.00015	.00019	.00022	.00026	.00030
					Profiling	.1 x D	2-2.5 x D	490	.00010	.00020	.00031	.00041	.00051	.00061	.00072	.00083
High Temp Alloys	S	●	X	X	Slotting	-	.5 x D	100	.00003	.00006	.00009	.00012	.00016	.00019	.00022	.00025
					Profiling	.05 x D	2-2.5 x D	150	.00008	.00017	.00026	.00035	.00044	.00052	.00061	.00070
Titanium Alloys	S	●	X	X	Slotting	-	.5 x D	245	.00004	.00007	.00011	.00015	.00019	.00022	.00026	.00030
					Profiling	.1 x D	2-2.5 x D	350	.00006	.00012	.00019	.00025	.00031	.00037	.00044	.00050

Please Note: Square corner tools recommended for finishing applications only.

3 x D Necked Tools (3MVS - N3)

Workpiece Material Group	ISO	Coolant ● Preferred ○ Possible X Not Possible			Application	Depth of Cut Per Application		Vc SFM	fz - in/tooth By Cutter Diameter							
		Max.	Air	MMS		Radial (Ae)	Axial (Ap)		0.015	0.031	0.047	0.062	0.078	0.093	0.109	0.125
Moderate Machining & PH Stainless Steels	M	●	X	○	Slotting	-	.5 x D	245	.00004	.00007	.00011	.00015	.00019	.00022	.00026	.00030
					Profiling	.1 x D	1 x D	490	.00010	.00020	.00031	.00041	.00051	.00061	.00072	.00083
High Temp Alloys	S	●	X	X	Slotting	-	.5 x D	100	.00003	.00006	.00009	.00012	.00016	.00019	.00022	.00025
					Profiling	.05 x D	1 x D	150	.00008	.00017	.00026	.00035	.00044	.00052	.00061	.00070
Titanium Alloys	S	●	X	X	Slotting	-	.5 x D	245	.00004	.00007	.00011	.00015	.00019	.00022	.00026	.00030
					Profiling	.1 x D	1 x D	350	.00006	.00012	.00019	.00025	.00031	.00037	.00044	.00050

Please Note: Square corner tools recommended for finishing applications only.

5 x D Necked Tools (3MVS - N5)

Workpiece Material Group	ISO	Coolant ● Preferred ○ Possible X Not Possible			Application	Depth of Cut Per Application		Vc SFM	fz - in/tooth By Cutter Diameter							
		Max.	Air	MMS		Radial (Ae)	Axial (Ap)		0.015	0.031	0.047	0.062	0.078	0.093	0.109	0.125
Moderate Machining & PH Stainless Steels	M	●	X	○	Slotting	-	.3 x D	245	.00004	.00007	.00011	.00015	.00019	.00022	.00026	.00030
					Profiling	.08 x D	1 x D	490	.00010	.00020	.00031	.00041	.00051	.00061	.00072	.00083
High Temp Alloys	S	●	X	X	Slotting	-	.3 x D	100	.00003	.00006	.00009	.00012	.00016	.00019	.00022	.00025
					Profiling	.05 x D	1 x D	150	.00008	.00017	.00026	.00035	.00044	.00052	.00061	.00070
Titanium Alloys	S	●	X	X	Slotting	-	.3 x D	245	.00004	.00007	.00011	.00015	.00019	.00022	.00026	.00030
					Profiling	.08 x D	1 x D	350	.00006	.00012	.00019	.00025	.00031	.00037	.00044	.00050

Please Note: Square corner tools recommended for finishing applications only.

Technical data provided should be considered advisory only as variations may be necessary depending on the particular application.



3MV Series Recommended Cutting Data - Inch Continued

8 x D Necked Tools (3MVS - N8)

Workpiece Material Group	ISO	Coolant ● Preferred ○ Possible X Not Possible			Application	Depth of Cut Per Application		Vc SFM	fz - in/tooth By Cutter Diameter							
		Max.	Air	MMS		Radial (Ae)	Axial (Ap)		0.015	0.031	0.047	0.062	0.078	0.093	0.109	0.125
Moderate Machining & PH Stainless Steels	M	●	X	○	Slotting	-	.2 x D	245	.00004	.00007	.00011	.00015	.00019	.00022	.00026	.00030
					Profiling	.05 x D	.75 x D	490	.00010	.00020	.00031	.00041	.00051	.00061	.00072	.00083
High Temp Alloys	S	●	X	X	Slotting	-	.2 x D	100	.00003	.00006	.00009	.00012	.00016	.00019	.00022	.00025
					Profiling	.05 x D	.75 x D	150	.00008	.00017	.00026	.00035	.00044	.00052	.00061	.00070
Titanium Alloys	S	●	X	X	Slotting	-	.2 x D	245	.00004	.00007	.00011	.00015	.00019	.00022	.00026	.00030
					Profiling	.05 x D	.75 x D	350	.00006	.00012	.00019	.00025	.00031	.00037	.00044	.00050

Please Note: Square corner tools recommended for finishing applications only.

10 x D Necked Tools (3MVS - N10)

Workpiece Material Group	ISO	Coolant ● Preferred ○ Possible X Not Possible			Application	Depth of Cut Per Application		Vc SFM	fz - in/tooth By Cutter Diameter							
		Max.	Air	MMS		Radial (Ae)	Axial (Ap)		0.015	0.031	0.047	0.062	0.078	0.093	0.109	0.125
Moderate Machining & PH Stainless Steels	M	●	X	○	Slotting	-	.15 x D	245	.00003	.00006	.00009	.00012	.00016	.00019	.00022	.00025
					Profiling	.5 x D	.15 x D	245	.00003	.00006	.00009	.00012	.00016	.00019	.00022	.00025
High Temp Alloys	S	●	X	X	Slotting	-	.15 x D	100	.00002	.00005	.00008	.00010	.00012	.00015	.00017	.00020
					Profiling	.5 x D	.15 x D	100	.00002	.00005	.00008	.00010	.00012	.00015	.00017	.00020
Titanium Alloys	S	●	X	X	Slotting	-	.15 x D	245	.00003	.00006	.00009	.00012	.00016	.00019	.00022	.00025
					Profiling	.5 x D	.15 x D	245	.00003	.00006	.00009	.00012	.00016	.00019	.00022	.00025

Please Note: Square corner tools recommended for finishing applications only.

12 x D Necked Tools (3MVS - N12)

Workpiece Material Group	ISO	Coolant ● Preferred ○ Possible X Not Possible			Application	Depth of Cut Per Application		Vc SFM	fz - in/tooth By Cutter Diameter							
		Max.	Air	MMS		Radial (Ae)	Axial (Ap)		0.015	0.031	0.047	0.062	0.078	0.093	0.109	0.125
Moderate Machining & PH Stainless Steels	M	●	X	○	Slotting	-	.1 x D	245	.00003	.00006	.00009	.00012	.00016	.00019	.00022	.00025
					Profiling	.5 x D	.1 x D	245	.00003	.00006	.00009	.00012	.00016	.00019	.00022	.00025
High Temp Alloys	S	●	X	X	Slotting	-	.1 x D	100	.00002	.00005	.00008	.00010	.00012	.00015	.00017	.00020
					Profiling	.5 x D	.1 x D	100	.00002	.00005	.00008	.00010	.00012	.00015	.00017	.00020
Titanium Alloys	S	●	X	X	Slotting	-	.1 x D	245	.00003	.00006	.00009	.00012	.00016	.00019	.00022	.00025
					Profiling	.5 x D	.1 x D	245	.00003	.00006	.00009	.00012	.00016	.00019	.00022	.00025

Please Note: Square corner tools recommended for finishing applications only.

15 x D Necked Tools (3MVS - N15)

Workpiece Material Group	ISO	Coolant ● Preferred ○ Possible X Not Possible			Application	Depth of Cut Per Application		Vc SFM	fz - in/tooth By Cutter Diameter							
		Max.	Air	MMS		Radial (Ae)	Axial (Ap)		0.015	0.031	0.047	0.062	0.078	0.093	0.109	0.125
Moderate Machining & PH Stainless Steels	M	●	X	○	Slotting	-	.07 x D	245	.00003	.00006	.00009	.00012	.00016	.00019	.00022	.00025
					Profiling	.5 x D	.07 x D	245	.00003	.00006	.00009	.00012	.00016	.00019	.00022	.00025
High Temp Alloys	S	●	X	X	Slotting	-	.07 x D	100	.00002	.00005	.00008	.00010	.00012	.00015	.00017	.00020
					Profiling	.5 x D	.07 x D	100	.00002	.00005	.00008	.00010	.00012	.00015	.00017	.00020
Titanium Alloys	S	●	X	X	Slotting	-	.07 x D	245	.00003	.00006	.00009	.00012	.00016	.00019	.00022	.00025
					Profiling	.5 x D	.07 x D	245	.00003	.00006	.00009	.00012	.00016	.00019	.00022	.00025

Please Note: Square corner tools recommended for finishing applications only.

Technical data provided should be considered advisory only as variations may be necessary depending on the particular application.



3MV Series Recommended Cutting Data - Metric

Stub Flute Length Tools (3MVS)

Workpiece Material Group	ISO	Coolant			Application	Depth of Cut Per Application		Vc m/min	fz - mm/tooth By Cutter Diameter					
		● Preferred ○ Possible X Not Possible				Radial (Ae)	Axial (Ap)		0.5	1.0	1.5	2.0	2.5	3.0
		Max.	Air	MMS										
Moderate Machining & PH Stainless Steels	M	●	X	○	Slotting	-	.5 x D	75	.0012	.0024	.0036	.0048	.0060	.0072
					Profiling	.2 x D	1 x D	150	.0033	.0066	.0099	.0132	.0165	.0198
High Temp Alloys	S	●	X	X	Slotting	-	.5 x D	30	.0010	.0020	.0030	.0040	.0050	.0060
					Profiling	.1 x D	1 x D	45	.0028	.0056	.0084	.0112	.0140	.0168
Titanium Alloys	S	●	X	X	Slotting	-	.5 x D	75	.0012	.0024	.0036	.0048	.0060	.0072
					Profiling	.2 x D	1 x D	107	.0020	.0040	.0060	.0080	.0100	.0120

Please Note: Square corner tools recommended for finishing applications only.

Regular Flute Length Tools (3MVR)

Workpiece Material Group	ISO	Coolant			Application	Depth of Cut Per Application		Vc m/min	fz - mm/tooth By Cutter Diameter					
		● Preferred ○ Possible X Not Possible				Radial (Ae)	Axial (Ap)		0.5	1.0	1.5	2.0	2.5	3.0
		Max.	Air	MMS										
Moderate Machining & PH Stainless Steels	M	●	X	○	Slotting	-	.5 x D	75	.0012	.0024	.0036	.0048	.0060	.0072
					Profiling	.1 x D	2-2.5 x D	150	.0033	.0066	.0099	.0132	.0165	.0198
High Temp Alloys	S	●	X	X	Slotting	-	.5 x D	30	.0010	.0020	.0030	.0040	.0050	.0060
					Profiling	.05 x D	2-2.5 x D	45	.0028	.0056	.0084	.0112	.0140	.0168
Titanium Alloys	S	●	X	X	Slotting	-	.5 x D	75	.0012	.0024	.0036	.0048	.0060	.0072
					Profiling	.1 x D	2-2.5 x D	107	.0020	.0040	.0060	.0080	.0100	.0120

Please Note: Square corner tools recommended for finishing applications only.

5 x D Necked Tools (3MVS - N5)

Workpiece Material Group	ISO	Coolant			Application	Depth of Cut Per Application		Vc m/min	fz - mm/tooth By Cutter Diameter					
		● Preferred ○ Possible X Not Possible				Radial (Ae)	Axial (Ap)		0.5	1.0	1.5	2.0	2.5	3.0
		Max.	Air	MMS										
Moderate Machining & PH Stainless Steels	M	●	X	○	Slotting	-	.3 x D	75	.0012	.0024	.0036	.0048	.0060	.0072
					Profiling	.08 x D	1 x D	150	.0033	.0066	.0099	.0132	.0165	.0198
High Temp Alloys	S	●	X	X	Slotting	-	.3 x D	30	.0010	.0020	.0030	.0040	.0050	.0060
					Profiling	.05 x D	1 x D	45	.0028	.0056	.0084	.0112	.0140	.0168
Titanium Alloys	S	●	X	X	Slotting	-	.3 x D	75	.0012	.0024	.0036	.0048	.0060	.0072
					Profiling	.08 x D	1 x D	107	.0020	.0040	.0060	.0080	.0100	.0120

Please Note: Square corner tools recommended for finishing applications only.

8 x D Necked Tools (3MVS - N8)

Workpiece Material Group	ISO	Coolant			Application	Depth of Cut Per Application		Vc m/min	fz - mm/tooth By Cutter Diameter					
		● Preferred ○ Possible X Not Possible				Radial (Ae)	Axial (Ap)		0.5	1.0	1.5	2.0	2.5	3.0
		Max.	Air	MMS										
Moderate Machining & PH Stainless Steels	M	●	X	○	Slotting	-	.2 x D	75	.0012	.0024	.0036	.0048	.0060	.0072
					Profiling	.05 x D	.75 x D	150	.0033	.0066	.0099	.0132	.0165	.0198
High Temp Alloys	S	●	X	X	Slotting	-	.2 x D	30	.0010	.0020	.0030	.0040	.0050	.0060
					Profiling	.05 x D	.75 x D	45	.0028	.0056	.0084	.0112	.0140	.0168
Titanium Alloys	S	●	X	X	Slotting	-	.2 x D	75	.0012	.0024	.0036	.0048	.0060	.0072
					Profiling	.05 x D	.75 x D	107	.0020	.0040	.0060	.0080	.0100	.0120

Please Note: Square corner tools recommended for finishing applications only.

Technical data provided should be considered advisory only as variations may be necessary depending on the particular application.



156 Recommended Cutting Data - Contouring

Inch If axial depth (ap) is less than the ball diameter, the speed is figured using the effective cutting diameter.

Workpiece Material Group	ISO	Hardness	Coolant • Preferred o Possible x Not Possible			End Mill Diameter							
			Max.	Air	MMS	1/32		1/16		3/32		1/8	
						RPM (n)	IPM (vf)	RPM (n)	IPM (vf)	RPM (n)	IPM (vf)	RPM (n)	IPM (vf)
Tool Steels & Die Steels O7, M1, M2, M3, M4, M7, T1, T2, T4, T5, T8, T15, A2, A3, A6, A7, H10, H11, H12, H13, H19, H21, L3, L6, L7, P2, P20, S1, S5, S7, 52100, A128, D2, D3, D4, D5, D7	P	28 to 44 Rc	•	•	•	30000	26.9	30000	62	25000	84	17500	95
Hardened Steels	H	40-45 Rc				30000	24	23500	57	22000	96	14500	90
Hardened Steels		46-55 Rc	•	o	o	30000	18	23500	37	20000	35	12000	35
Hardened Steels		55-60 Rc				30000	15	15000	15	10000	15	7000	15
Stainless Steel - Ferritic / Martensitic / PH	M	over 28 Rc	•	x	o	30000	26	30000	62	25000	85	17500	95

Axial & Radial Depth - Roughing / Semi Finishing

- 30 - 40 Rc 10% of Diameter ap
- 40 - 50 Rc 5% of Diameter ap
- 50 - 60 Rc 4% of Diameter ap
- Radial Step Over 25%-40% of Diameter

Axial & Radial Depth - Finishing

- < 40 Rc 3% of Diameter ap
- 40 - 50 Rc 2% of Diameter ap
- 50 - 60 Rc 1% of Diameter ap
- ae (step over) depends on finish requirement of the part.

Technical data provided should be considered advisory only as variations may be necessary depending on the particular application.



156 Recommended Cutting Data - Contouring

Metric If axial depth (ap) is less than the ball diameter, the speed is figured using the effective cutting diameter.

Workpiece Material Group	ISO	Hardness	Coolant • Preferred o Possible x Not Possible			End Mill Diameter (mm)									
						0.5		1.0		1.5		2.0		3.0	
			Max.	Air	MMS	RPM (n)	mm/min (vf)	RPM (n)	mm/min (vf)	RPM (n)	mm/min (vf)	RPM (n)	mm/min (vf)	RPM (n)	mm/min (vf)
Tool Steels & Die Steels O7, M1, M2, M3, M4, M7, T1, T2, T4, T5, T8, T15, A2, A3, A6, A7, H10, H11, H12, H13, H19, H21, L3, L6, L7, P2, P20, S1, S5, S7, 52100, A128, D2, D3, D4, D5, D7	P	28 to 44 Rc	•	•	•	30000	508	30000	683	25000	1575	17500	2133	14000	2392
Hardened Steels	H	40-45 Rc				30000	508	30000	608	23500	1450	22000	2442	14500	2283
Hardened Steels		46-55 Rc	•	o	o	30000	308	30000	458	23500	942	20000	892	12000	892
Hardened Steels		55-60 Rc				30000	250	30000	383	15000	383	10000	383	7000	383
Stainless Steel - Ferritic / Martensitic / PH	M	over 28 Rc	•	x	o	30000	508	30000	683	30000	1575	25000	2133	17500	2392

Axial & Radial Depth - Roughing / Semi Finishing

30 - 40 Rc 10% of Diameter ap
 40 - 50 Rc 5% of Diameter ap
 50 - 60 Rc 4% of Diameter ap
 Radial Step Over 25%-40% of Diameter

Axial & Radial Depth - Finishing

< 40 Rc 3% of Diameter ap
 40 - 50 Rc 2% of Diameter ap
 50 - 60 Rc 1% of Diameter ap
 ae (step over) depends on finish requirement of the part.

Technical data provided should be considered advisory only as variations may be necessary depending on the particular application.



158 Recommended Cutting Data - Inch

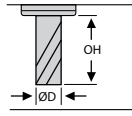

Technical Information

MICRO End Mills

Workpiece Material Group	Material Type	Coolant		OH	Vc-SFM	Tool Diameter and Corner Radius								
						.0787 x R.0197			.1181 x R.0315					
		Air	Emulsion			2.0 x R0.5		3.0 x R0.8						
						Ap	Ae	Fz	Ap	Ae	Fz			
Steel	Alloy & Tool Steel Below 260HB	●	○	3D	395	.0039	.020	.0039	.0063	.028	.0063			
				4D	360	.0035						.0039	.0055	.0063
				5D	330	.0035								
				6D	310	.0028								
				8D	280	.0024								
	10D	230	.0020	.020	.0035	.0051	.028	.0055						
	3D	310	.0031						.0035	.0047	.0055			
	4D	280	.0028											
	5D	260	.0028											
	6D	245	.0020											
8D	215	.0020	.020	.0035	.0031	.028	.0055							
10D	180	.0016						.0035	.0024	.0055				
3D	230	.0031									.0035	.0047	.0055	
4D	215	.0028												
5D	200	.0028												
6D	180	.0020												
8D	165	.0020	.020	.0035	.0031	.028	.0055							
10D	130	.0016						.0035	.0024	.0055				
3D	100	.0012									.0020	.0016	.0031	
4D	80	.0008												
5D	80	.0008												
6D	80	.0008												
8D	65	.0008	.016	.0020	.0008	.024	.0031							
10D	65	.0004						.0020	.0012	.0031				
3D	230	.0024									.0031	.0028	.0047	
4D	215	.0020												
5D	200	.0020												
6D	180	.0016												
8D	165	.0012	.016	.0031	.0020	.024	.0047							
10D	130	.0012						.0031	.0016	.0047				
3D	395	.0039									.0039	.0063	.028	.0063
4D	360	.0035												
5D	330	.0035												
6D	310	.0028												
8D	280	.0024	.020	.0039	.0039	.028	.0063							
10D	230	.0020						.0039	.0031	.0063				
3D	260	.0024									.0028	.0039	.0043	
4D	230	.0020												
5D	230	.0020												
6D	215	.0016												
8D	180	.0016	.020	.0028	.0024	.028	.0043							
10D	165	.0012						.0028	.0020	.0043				
3D	200	.0020									.0020	.0031	.0031	
4D	180	.0020												
5D	165	.0016												
6D	165	.0012												
8D	130	.0012	.016	.0020	.0020	.024	.0031							
10D	115	.0012						.0020	.0016	.0031				

● Preferred ○ Possible X Not Possible

Technical data provided should be considered advisory only as variations may be necessary depending on the particular application.



158 Recommended Cutting Data - Metric

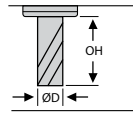

Workpiece Material Group	Material Type	Coolant		OH	Vc-M/Min	Tool Diameter and Corner Radius									
		Air	Emulsion			2.0 x R0.5			3.0 x R0.8						
						Ap	Ae	Fz	Ap	Ae	Fz				
Steel	P	●	○	3D	120	0.10	0.5	0.10	0.16	0.7	0.16				
				4D	110							0.09	0.10	0.14	0.16
				5D	100							0.09	0.10	0.14	0.16
				6D	95							0.07	0.10	0.11	0.16
				8D	85							0.06	0.10	0.10	0.16
	10D	70	0.05	0.10	0.08	0.16									
	Pre-hardened Tool Steel HRC30-40	●	○	3D	95	0.08	0.5	0.09	0.13	0.7	0.14				
				4D	85							0.07	0.09	0.12	0.14
				5D	80							0.07	0.09	0.11	0.14
				6D	75							0.05	0.09	0.09	0.14
8D				65	0.05							0.09	0.08	0.14	
10D	55	0.04	0.09	0.06	0.14										
Stainless Steel	M	X	●	3D	70	0.08	0.5	0.09	0.13	0.7	0.14				
				4D	65							0.07	0.09	0.12	0.14
				5D	60							0.07	0.09	0.11	0.14
				6D	55							0.05	0.09	0.09	0.14
				8D	50							0.05	0.09	0.08	0.14
10D	40	0.04	0.09	0.06	0.14										
Special Alloys	S	X	●	3D	30	0.03	0.4	0.05	0.04	0.6	0.08				
				4D	25							0.02	0.05	0.04	0.08
				5D	25							0.02	0.05	0.03	0.08
				6D	25							0.02	0.05	0.03	0.08
				8D	20							0.02	0.05	0.02	0.08
	10D	20	0.01	0.05	0.02	0.08									
	Titanium Alloys	X	●	3D	70	0.06	0.4	0.08	0.09	0.6	0.12				
				4D	65							0.05	0.08	0.08	0.12
				5D	60							0.05	0.08	0.07	0.12
				6D	55							0.04	0.08	0.06	0.12
8D				50	0.03							0.08	0.05	0.12	
10D	40	0.03	0.08	0.04	0.12										
Cast Iron	K	●	●	3D	120	0.10	0.5	0.10	0.16	0.7	0.16				
				4D	110							0.09	0.10	0.14	0.16
				5D	100							0.09	0.10	0.14	0.16
				6D	95							0.07	0.10	0.11	0.16
				8D	85							0.06	0.10	0.10	0.16
10D	70	0.05	0.10	0.08	0.16										
Hardened Steels	H	●	○	3D	80	0.06	0.5	0.07	0.10	0.7	0.11				
				4D	70							0.05	0.07	0.09	0.11
				5D	70							0.05	0.07	0.08	0.11
				6D	65							0.04	0.07	0.07	0.11
				8D	55							0.04	0.07	0.06	0.11
	10D	50	0.03	0.07	0.05	0.11									
	Hardened Steels HRC50-55	●	X	3D	60	0.05	0.4	0.05	0.08	0.6	0.08				
				4D	55							0.05	0.05	0.07	0.08
				5D	50							0.04	0.05	0.07	0.08
				6D	50							0.03	0.05	0.05	0.08
8D				40	0.03							0.05	0.05	0.08	
10D	35	0.03	0.05	0.04	0.08										

● Preferred ○ Possible X Not Possible

Technical data provided should be considered advisory only as variations may be necessary depending on the particular application.



158 Recommended Cutting Data - Inch

Technical Information

MICRO End Mills

Cutting Speed

Workpiece Material Group	Material Type	Coolant					
		Air	Emulsion	Slotting	Profiling	2D/3D HSC	
		Vc-SFM					
Steels	P	Alloy & Tool Steels Below 260HB	●	○	330	590	655
		Pre-hardened Tools Steel HRC30-40	●	●	230	395	590
Stainless Steels	M	Stainless Steels 300 & PH series	x	●	260	330	490
Special Alloys	S	High Temp Alloys	x	●	80	165	230
		Titanium Alloys	x	●	195	330	395
Cast Irons	K	GG, GGG	●	●	330	655	720
Hardened Steels	H	Hardened Steels HRC45-50	●	○	245	295	460
		Hardened Steels HRC50-55	●	○	130	230	395

● Preferred ○ Possible x Not Possible

Feed Per Tooth

Workpiece Material Group	Material Type	Operation	Tool Diameter		
			.0787	.1181	
			fz-in/tooth		
Steels	P	Alloy & Tool Steels Below 260HB	Slotting	.0004	.0006
			Profiling	.0008	.0012
			HSC 2D/3D	.0024	.0035
	P	Pre-hardened Tool Steels HRC30-40	Slotting	.0003	.0005
			Profiling	.0006	.0009
			HSC 2D/3D	.0020	.0030
Stainless Steels	M	Stainless Steel 300 & PH series	Slotting	.0003	.0004
			Profiling	.0005	.0008
			HSC 2D/3D	.0016	.0024
Special Alloys	S	High Temp Alloys	Slotting	.0002	.0002
			Profiling	.0003	.0005
			HSC 2D/3D	.0008	.0012
	S	Titanium Alloys	Slotting	.0002	.0004
			Profiling	.0005	.0007
			HSC 2D/3D	.0016	.0024
Cast Irons	K	GG, GGG	Slotting	.0004	.0006
			Profiling	.0008	.0012
			HSC 2D/3D	.0024	.0035
Hardened Steels	H	Hardened Steels HRC45-50	Slotting	.0003	.0004
			Profiling	.0005	.0008
			HSC 2D/3D	.0016	.0024
	H	Hardened Steels HRC50-55	Slotting	.0002	.0003
			Profiling	.0004	.0006
			HSC 2D/3D	.0012	.0018

Technical data provided should be considered advisory only as variations may be necessary depending on the particular application.



158 Recommended Cutting Data - Inch Continued

Depth of Cut HSC 2D/3D Axial & Radial

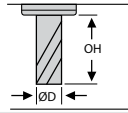

Workpiece Material Group	Material Type	OH	Tool Diameter	
			.0787	.1181
			2.0	3.0
			Ap-in / Ae-in	
Steels	Alloy & Tool Steels Below 260HB	3D-4D	.0024	.0035
		5D-6D	.0020	.0028
		8D-10D	.0016	.0020
	Pre-hardened Tool Steels HRC30-40	3D-4D	.0024	.0035
		5D-6D	.0020	.0028
		8D-10D	.0016	.0020
Stainless Steels	Stainless Steel 300 & PH series	3D-4D	.0024	.0035
		5D-6D	.0020	.0028
		8D-10D	.0016	.0020
Special Alloys	High Temp Alloys	3D-4D	.0016	.0024
		5D-6D	.0012	.0020
		8D-10D	.0008	.0016
	Titanium Alloys	3D-4D	.0024	.0035
		5D-6D	.0020	.0028
		8D-10D	.0016	.0020
Cast Irons	GG, GGG	3D-4D	.0024	.0035
		5D-6D	.0020	.0028
		8D-10D	.0016	.0020
Hardened Steels	Hardened Steels HRC45-50	3D-4D	.0020	.0031
		5D-6D	.0016	.0024
		8D-10D	.0012	.0020
	Hardened Steels HRC50-55	3D-4D	.0016	.0024
		5D-6D	.0012	.0020
		8D-10D	.0008	.0016

Notes:

For profile machining adjust radial cut (Ae)

OH	Ae (x Ø)
3D-4D	0.10
5D-6D	0.07
8D-10D	0.05

Radial Cut (Ae)	Chip thickness Compensation factor
30%	1.10
20%	1.20
15%	1.40
10%	1.80
5%	2.30
1%	5.00

For slotting adjust axial cut (Ap)

OH	Ap (x Ø)
3D-4D	0.10
5D-6D	0.07
8D-10D	0.05

Technical data provided should be considered advisory only as variations may be necessary depending on the particular application.



158 Recommended Cutting Data - Metric

Technical Information

MICRO End Mills

Cutting Speed

Workpiece Material Group	Material Type	Coolant					
		Air	Emulsion	Slotting	Profiling	2D/3D HSC	
Vc-M/Min							
Steels	P	Alloy & Tool Steels Below 260HB	●	○	100	180	200
		Pre-hardened Tools Steel HRC30-40	●	●	70	120	180
Stainless Steels	M	Stainless Steels 300 & PH series	X	●	80	100	150
Special Alloys	S	High Temp Alloys	X	●	25	50	70
		Titanium Alloys	X	●	60	100	120
Cast Irons	K	GG, GGG	●	●	100	200	220
Hardened Steels	H	Hardened Steels HRC45-50	●	○	75	90	140
		Hardened Steels HRC50-55	●	○	40	70	120

● Preferred ○ Possible x Not Possible

Feed Per Tooth

Workpiece Material Group	Material Type	Operation	Tool Diameter		
			2.0	3.0	
			fz-mm/tooth		
Steels	P	Alloy & Tool Steels Below 260HB	Slotting	0.010	0.015
			Profiling	0.020	0.030
			HSC 2D/3D	0.060	0.090
	Pre-hardened Tool Steels HRC30-40	Slotting	0.008	0.012	
		Profiling	0.016	0.024	
		HSC 2D/3D	0.050	0.075	
Stainless Steels	M	Stainless Steel 300 & PH series	Slotting	0.007	0.010
			Profiling	0.013	0.020
			HSC 2D/3D	0.040	0.060
Special Alloys	S	High Temp Alloys	Slotting	0.004	0.006
			Profiling	0.008	0.013
			HSC 2D/3D	0.020	0.030
	Titanium Alloys	Slotting	0.006	0.009	
		Profiling	0.012	0.018	
		HSC 2D/3D	0.040	0.060	
Cast Irons	K	GG, GGG	Slotting	0.010	0.015
			Profiling	0.020	0.030
			HSC 2D/3D	0.060	0.090
Hardened Steels	H	Hardened Steels HRC45-50	Slotting	0.007	0.010
			Profiling	0.013	0.020
			HSC 2D/3D	0.040	0.060
	Hardened Steels HRC50-55	Slotting	0.005	0.008	
		Profiling	0.010	0.015	
		HSC 2D/3D	0.030	0.045	

Technical data provided should be considered advisory only as variations may be necessary depending on the particular application.



158 Recommended Cutting Data - Metric Continued

Depth of Cut HSC 2D/3D Axial & Radial

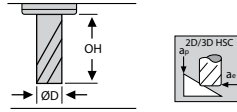

Workpiece Material Group	Material Type	OH	Tool Diameter	
			2.0	3.0
			Ap-mm / Ae-mm	
Steels	Alloy & Tool Steels Below 260HB	3D-4D	0.06	0.09
		5D-6D	0.05	0.07
		8D-10D	0.04	0.05
	Pre-hardened Tool Steels HRC30-40	3D-4D	0.06	0.09
		5D-6D	0.05	0.07
		8D-10D	0.04	0.05
Stainless Steels	Stainless Steel 300 & PH series	3D-4D	0.06	0.09
		5D-6D	0.05	0.07
		8D-10D	0.04	0.05
Special Alloys	High Temp Alloys	3D-4D	0.04	0.06
		5D-6D	0.03	0.05
		8D-10D	0.02	0.04
	Titanium Alloys	3D-4D	0.06	0.09
		5D-6D	0.05	0.07
		8D-10D	0.04	0.05
Cast Irons	GG, GGG	3D-4D	0.06	0.09
		5D-6D	0.05	0.07
		8D-10D	0.04	0.05
Hardened Steels	Hardened Steels HRC45-50	3D-4D	0.05	0.08
		5D-6D	0.04	0.06
		8D-10D	0.03	0.05
	Hardened Steels HRC50-55	3D-4D	0.04	0.06
		5D-6D	0.03	0.05
		8D-10D	0.02	0.04

Notes:

For profile machining adjust radial cut (Ae)

OH	Ae (x Ø)
3D-4D	0.10
5D-6D	0.07
8D-10D	0.05

Radial Cut (Ae)	Chip thickness Compensation factor
30%	1.10
20%	1.20
15%	1.40
10%	1.80
5%	2.30
1%	5.00

For slotting adjust axial cut (Ap)

OH	Ap (x Ø)
3D-4D	0.10
5D-6D	0.07
8D-10D	0.05

Technical data provided should be considered advisory only as variations may be necessary depending on the particular application.



End Mill Terminology

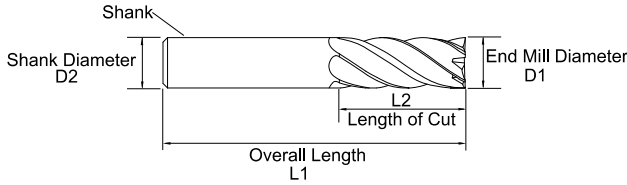

Length of Cut (Flute Length) – Always select the shortest Flute Length possible for your application. By selecting the shortest Flute Length, you can increase rigidity and allow for higher feed rates.

End Mill Diameter – Always select the largest diameter possible for your milling operation. Increasing your diameter by just 10%, can increase your rigidity by 25%.

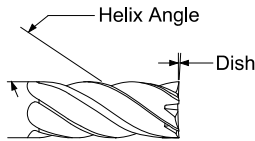

Helix Angle – Varies from 0 to 60 degrees. Higher helix angles can increase the number of teeth in a cut, and help in redirecting cutting forces. This is beneficial in harder to machine materials in particular. Changes in helix angle can also greatly affect the flute form of an end mill, and affect chip evacuation.

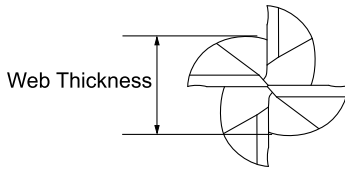

Web Thickness – The cross section of the fluting of the end mill. Larger webs allow for more rigidity, while smaller webs allow for better chip evacuation. This feature is highly dependent on the material being machined.

Rake Angle – The measurement of the curvature of the cutting edge in the face of the flute. A high rake angle will cut more aggressively, while a lower rake angle will increase the strength of the cutting edge.

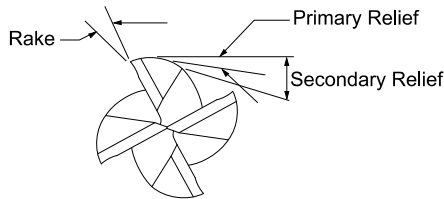

Primary Relief – The clearance directly behind the cutting edge. High primary relief angles will allow for more aggressive milling, while lower relief angles will increase the strength of the cutting edge. The primary relief will also affect the wear on a cutting edge. Lower primary relief angles can tend to develop larger wear lands.

Technical data provided should be considered advisory only as variations may be necessary depending on the particular application.







Micro End Mill Recommended Cutting Data - Profile Milling

Length	2 Flute Series		3 Flute Series	4 Flute Series	
Standard	121	150	116	111	140

Inch - Standard

Ball Nose End Mills - If axial depth (ap) is less than the ball diameter, the speed is figured using the effective cutting diameter.

Workpiece Material Group	ISO	Hardness	Coolant			Profile Milling 	End Mill Diameter (Inch)							
			● Preferred ○ Possible x Not Possible				vc - SFM Increase speed by 30% for ALtima® coated tools.	.0150 .0310 .0470			.0620 .0780 .0930 .1250			
								13% Dia. ae			25% Dia. ae			
								<2 Dia. ap			<2 Dia. ap			
						fz - in/tooth								
Free Machining & Low Carbon Steels 1006, 1008, 1015, 1018, 1020, 1022, 1025, 1117, 1140, 1141, 11L08, 11L14, 1213, 12L13, 12L14, 1215, 1330	P	up to 28 Rc	●	●	●	400	0.00007	0.00015	0.00023	0.00027	0.00034	0.00040	0.00054	
Medium Carbon & High Carbon Steels, Alloy Steels & Easy to Machine Tool Steels 1030, 1035, 1040, 1045, 1050, 1052, 1055, 1060, 1085, 1095, 1541, 1551, 9255, 2515, 3135, 3415, 4130, 4137, 4140, 4150, 4320, 4340, 4520, 5015, 5115, 5120, 5132, 5140, 5155, 6150, 8620, 9262, 9840, 52100, O1, O2, O6, S2, W1 to W310	P	28 to 38 Rc	●	●	●	300	0.00007	0.00015	0.00023	0.00027	0.00034	0.00040	0.00054	
Tool Steels & Die Steels O7, M1, M2, M3, M4, M7, T1, T2, T4, T5, T8, T15, A2, A3, A6, A7, H10, H11, H12, H13, H19, H21, L3, L6, L7, P2, P20, S1, S5, S7, 52100, A 128, D2, D3, D4, D5, D7	P	28 to 44 Rc	●	●	●	200	0.00007	0.00015	0.00023	0.00027	0.00034	0.00040	0.00054	
Hardened Steels	H	45-55 Rc	●	○	○	100	0.00010	0.00030	0.00050	0.00140	0.00180	0.00210	0.00300	
Stainless Steel - Easy to Machine 430F, 301, 303, 410, 416 Annealed, 420F, 430, 430F	M	up to 28 Rc	●	x	○	400	0.00007	0.00015	0.00023	0.00027	0.00034	0.00040	0.00054	
Stainless Steel - Moderately Difficult 301, 302, 303 High Tensile, 304, 304L, 305, 420, 15-5PH, 17-4PH, 17-7PH	M	up to 28 Rc	●	x	○	200	0.00007	0.00015	0.00023	0.00027	0.00034	0.00040	0.00054	
Stainless Steel - Difficult to Machine 302B, 304B, 309, 310, 316, 316B, 316L, 316Ti, 317, 317L, 321, PH13-8Mo, Nitronics	M	over 28 Rc	●	x	○	150	0.00007	0.00015	0.00023	0.00027	0.00034	0.00040	0.00054	
Cast Iron	K	160-200 HB	●	○	○	400	0.00007	0.00015	0.00023	0.00027	0.00034	0.00040	0.00054	
Malleable / Ductile Cast Iron	K	200-250 HB	●	○	○	250	0.00007	0.00015	0.00023	0.00027	0.00034	0.00040	0.00054	
High Temp Alloys Nimonics, Inconel, Monel, Hastelloy	S	up to 42 Rc	●	x	x	70	0.00004	0.00008	0.00015	0.00023	0.00027	0.00034	0.00040	
Titanium Alloys 6Al-4V, 5Al-2.5 Sn, 6Al-2 Sn-4Zr-6Mo, 3Al-8V-6Cr-4Mo-4Zr, 10V-2Fe-3Al, 13V-11Cr-3Al	S	up to 42 Rc	●	x	x	150	0.00004	0.00008	0.00015	0.00023	0.00027	0.00034	0.00040	
Aluminum < 10 % Si	N		●			750	0.00007	0.00015	0.00023	0.00027	0.00034	0.00040	0.00054	
Aluminum > 10 % Si	N		●			750	0.00007	0.00015	0.00023	0.00027	0.00034	0.00040	0.00054	

Technical data provided should be considered advisory only as variations may be necessary depending on the particular application.



Micro End Mill Recommended Cutting Data - Profile Milling

Length	2 Flute Series		3 Flute Series	4 Flute Series	
Standard	121	150	116	111	140

Metric - Standard

Ball Nose End Mills - If axial depth (ap) is less than the ball diameter, the speed is figured using the effective cutting diameter.

Workpiece Material Group	ISO	Hardness	Coolant			Profile Milling	End Mill Diameter (mm)							
			● Preferred ○ Possible x Not Possible				vc - m/min Increase speed by 30% for ALtima® coated tools.	.4	.8	1.2	1.6	2.0	2.5	3.0
								13% Dia. ae			25% Dia. ae			
			Max.	Air	MMS			<2 Dia. ap			<2 Dia. ap			
						fz - mm/tooth								
Free Machining & Low Carbon Steels 1006, 1008, 1015, 1018, 1020, 1022, 1025, 1117, 1140, 1141, 11L08, 11L14, 1213, 12L13, 12L14, 1215, 1330	P	up to 28 Rc	●	●	●	122	0.00170	0.00380	0.00580	0.00680	0.00860	0.01010	0.01370	
Medium Carbon & High Carbon Steels, Alloy Steels & Easy to Machine Tool Steels 1030, 1035, 1040, 1045, 1050, 1052, 1055, 1060, 1085, 1095, 1541, 1551, 9255, 2515, 3135, 3415, 4130, 4137, 4140, 4150, 4320, 4340, 4520, 5015, 5115, 5120, 5132, 5140, 5155, 6150, 8620, 9262, 9840, 52100, O1, O2, O6, S2, W1 to W310	P	28 to 38 Rc	●	●	●	92	0.00170	0.00380	0.00580	0.00680	0.00860	0.01010	0.01370	
Tool Steels & Die Steels O7, M1, M2, M3, M4, M7, T1, T2, T4, T5, T8, T15, A2, A3, A6, A7, H10, H11, H12, H13, H19, H21, L3, L6, L7, P2, P20, S1, S5, S7, 52100, A 128, D2, D3, D4, D5, D7	P	28 to 44 Rc	●	●	●	60	0.00170	0.00380	0.00580	0.00680	0.00860	0.01010	0.01370	
Hardened Steels	H	45-55 Rc	●	○	○	30	0.00250	0.00760	0.01270	0.03500	0.04500	0.05300	0.07600	
Stainless Steel - Easy to Machine 430F, 301, 303, 410, 416 Annealed, 420F, 430, 430F	M	up to 28 Rc	●	x	○	122	0.00170	0.00360	0.00580	0.00680	0.00860	0.01010	0.01370	
Stainless Steel - Moderately Difficult 301, 302, 303 High Tensile, 304, 304L, 305, 420, 15-5PH, 17-4PH, 17-7PH	M	up to 28 Rc	●	x	○	61	0.00170	0.00360	0.00580	0.00680	0.00860	0.01010	0.01370	
Stainless Steel - Difficult to Machine 302B, 304B, 309, 310, 316, 316B, 316L, 316Ti, 317, 317L, 321, PH13-8Mo, Nitronics	M	over 28 Rc	●	x	○	45	0.00170	0.00360	0.00580	0.00680	0.00860	0.01010	0.01370	
Cast Iron	K	160-200 HB	●	○	○	120	0.00170	0.00360	0.00580	0.00680	0.00860	0.01010	0.01370	
Malleable / Ductile Cast Iron	K	200-250 HB	●	○	○	76	0.00170	0.00360	0.00580	0.00680	0.00860	0.01010	0.01370	
High Temp Alloys Nimonic, Inconel, Monel, Hastelloy	S	up to 42 Rc	●	x	x	22	0.00100	0.00200	0.00380	0.00580	0.00680	0.00860	0.01010	
Titanium Alloys 6Al-4V, 5Al-2.5 Sn, 6Al-2 Sn-4Zr-6Mo, 3Al-8V-6Cr4Mo-4Zr, 10V-2Fe-3Al, 13V-11Cr-3Al	S	up to 42 Rc	●	x	x	45	0.00100	0.00200	0.00380	0.00580	0.00680	0.00860	0.01010	
Aluminum < 10 % Si	N		●			228	0.00170	0.00360	0.00580	0.00680	0.00860	0.01010	0.01370	
Aluminum > 10 % Si	N													

Technical data provided should be considered advisory only as variations may be necessary depending on the particular application.









Micro End Mill Recommended Cutting Data - Profile Milling

Length	2 Flute Series		3 Flute Series	4 Flute Series	
Stub	164	166	169	163	165

Inch - Stub Length

Ball Nose End Mills - If axial depth (ap) is less than the ball diameter, the speed is figured using the effective cutting diameter.

Workpiece Material Group	ISO	Hardness	Coolant			Profile Milling 	End Mill Diameter (Inch)						
			• Preferred o Possible x Not Possible				.0150	.0310	.0470	.0620	.0780	.0930	.1250
							13% Dia. ae			25% Dia. ae			
			Max.	Air	MMS		vc - SFM Increase speed by 30% for ALtima® coated tools.			fz - in/tooth			
Free Machining & Low Carbon Steels 1006, 1008, 1015, 1018, 1020, 1022, 1025, 1117, 1140, 1141, 11L08, 11L14, 1213, 12L13, 12L14, 1215, 1330	P	up to 28 Rc	•	•	•	400	0.00007	0.00015	0.00023	0.00027	0.00034	0.00040	0.00054
Medium Carbon & High Carbon Steels, Alloy Steels & Easy to Machine Tool Steels 1030, 1035, 1040, 1045, 1050, 1052, 1055, 1060, 1085, 1095, 1541, 1551, 9255, 2515, 3135, 3415, 4130, 4137, 4140, 4150, 4320, 4340, 4520, 5015, 5115, 5120, 5132, 5140, 5155, 6150, 8620, 9262, 9840, 52100, O1, O2, O6, S2, W1 to W310	P	28 to 38 Rc	•	•	•	300	0.00007	0.00015	0.00023	0.00027	0.00034	0.00040	0.00054
Tool Steels & Die Steels O7, M1, M2, M3, M4, M7, T1, T2, T4, T5, T8, T15, A2, A3, A6, A7, H10, H11, H12, H13, H19, H21, L3, L6, L7, P2, P20, S1, S5, S7, 52100, A 128, D2, D3, D4, D5, D7	P	28 to 44 Rc	•	•	•	200	0.00007	0.00015	0.00023	0.00027	0.00034	0.00040	0.00054
Hardened Steels	H	45-55 Rc	•	o	o	100	0.00010	0.00030	0.00050	0.00140	0.00180	0.00210	0.00300
Stainless Steel - Easy to Machine 430F, 301, 303, 410, 416 Annealed, 420F, 430, 430F	M	up to 28 Rc	•	x	o	400	0.00007	0.00015	0.00023	0.00027	0.00034	0.00040	0.00054
Stainless Steel - Moderately Difficult 301, 302, 303 High Tensile, 304, 304L, 305, 420, 15-5PH, 17-4PH, 17-7PH	M	up to 28 Rc	•	x	o	200	0.00007	0.00015	0.00023	0.00027	0.00034	0.00040	0.00054
Stainless Steel - Difficult to Machine 302B, 304B, 309, 310, 316, 316B, 316L, 316Ti, 317, 317L, 321, PH13-8Mo, Nitronics	M	over 28 Rc	•	x	o	150	0.00007	0.00015	0.00023	0.00027	0.00034	0.00040	0.00054
Cast Iron	K	160-200 HB	•	o	o	400	0.00007	0.00015	0.00023	0.00027	0.00034	0.00040	0.00054
Malleable / Ductile Cast Iron	K	200-250 HB	•	o	o	250	0.00007	0.00015	0.00023	0.00027	0.00034	0.00040	0.00054
High Temp Alloys Nimonics, Inconel, Monel, Hastelloy	S	up to 42 Rc	•	x	x	70	0.00004	0.00008	0.00015	0.00023	0.00027	0.00034	0.00040
Titanium Alloys 6Al-4V, 5Al-2.5 Sn, 6Al-2 Sn-4Zr-6Mo, 3Al-8V-6Cr4Mo-4Zr, 10V-2Fe-3Al, 13V-11Cr-3Al	S	up to 42 Rc	•	x	x	150	0.00004	0.00008	0.00015	0.00023	0.00027	0.00034	0.00040
Aluminum < 10 % Si	N		•			750	0.00007	0.00015	0.00023	0.00027	0.00034	0.00040	0.00054
Aluminum > 10 % Si	N		•										

Technical data provided should be considered advisory only as variations may be necessary depending on the particular application.







Micro End Mill Recommended Cutting Data - Profile Milling

Length	2 Flute Series		3 Flute Series	4 Flute Series	
	164	166	169	163	165
Stub					

Metric - Stub Length

Ball Nose End Mills - If axial depth (ap) is less than the ball diameter, the speed is figured using the effective cutting diameter.

Workpiece Material Group	ISO	Hardness	Coolant			Profile Milling 	End Mill Diameter (mm)						
			● Preferred	○ Possible	x Not Possible		.4	.8	1.2	1.6	2.0	2.5	3.0
							13% Dia. ae			25% Dia. ae			
			Max.	Air	MMS		vc - m/min Increase speed by 30% for ALtima® coated tools.			fz - mm/tooth			
Free Machining & Low Carbon Steels 1006, 1008, 1015, 1018, 1020, 1022, 1025, 1117, 1140, 1141, 11L08, 11L14, 1213, 12L13, 12L14, 1215, 1330	P	up to 28 Rc	●	●	●	122	0.00170	0.00380	0.00580	0.00680	0.00860	0.01010	0.01370
Medium Carbon & High Carbon Steels, Alloy Steels & Easy to Machine Tool Steels 1030, 1035, 1040, 1045, 1050, 1052, 1055, 1060, 1085, 1095, 1541, 1551, 9255, 2515, 3135, 3415, 4130, 4137, 4140, 4150, 4320, 4340, 4520, 5015, 5115, 5120, 5132, 5140, 5155, 6150, 8620, 9262, 9840, 52100, O1, O2, O6, S2, W1 to W310	P	28 to 38 Rc	●	●	●	92	0.00170	0.00380	0.00580	0.00680	0.00860	0.01010	0.01370
Tool Steels & Die Steels O7, M1, M2, M3, M4, M7, T1, T2, T4, T5, T8, T15, A2, A3, A6, A7, H10, H11, H12, H13, H19, H21, L3, L6, L7, P2, P20, S1, S5, S7, 52100, A 128, D2, D3, D4, D5, D7	P	28 to 44 Rc	●	●	●	60	0.00170	0.00380	0.00580	0.00680	0.00860	0.01010	0.01370
Hardened Steels	H	45-55 Rc	●	○	○	30	0.00250	0.00760	0.01270	0.03500	0.04500	0.05300	0.07600
Stainless Steel - Easy to Machine 430F, 301, 303, 410, 416 Annealed, 420F, 430, 430F	M	up to 28 Rc	●	x	○	122	0.00170	0.00360	0.00580	0.00680	0.00860	0.01010	0.01370
Stainless Steel - Moderately Difficult 301, 302, 303 High Tensile, 304, 304L, 305, 420, 15-5PH, 17-4PH, 17-7PH	M	up to 28 Rc	●	x	○	61	0.00170	0.00360	0.00580	0.00680	0.00860	0.01010	0.01370
Stainless Steel - Difficult to Machine 302B, 304B, 309, 310, 316, 316B, 316L, 316Ti, 317, 317L, 321, PH13-8Mo, Nitronics	M	over 28 Rc	●	x	○	45	0.00170	0.00360	0.00580	0.00680	0.00860	0.01010	0.01370
Cast Iron	K	160-200 HB	●	○	○	120	0.00170	0.00360	0.00580	0.00680	0.00860	0.01010	0.01370
Malleable / Ductile Cast Iron	K	200-250 HB	●	○	○	76	0.00170	0.00360	0.00580	0.00680	0.00860	0.01010	0.01370
High Temp Alloys Nimonic, Inconel, Monel, Hastelloy	S	up to 42 Rc	●	x	x	22	0.00100	0.00200	0.00380	0.00580	0.00680	0.00860	0.01010
Titanium Alloys 6Al-4V, 5Al-2.5 Sn, 6Al-2 Sn-4Zr-6Mo, 3Al-8V-6Cr-4Mo-4Zr, 10V-2Fe-3Al, 13V-11Cr-3Al	S	up to 42 Rc	●	x	x	45	0.00100	0.00200	0.00380	0.00580	0.00680	0.00860	0.01010
Aluminum < 10 % Si	N		●			228	0.00170	0.00360	0.00580	0.00680	0.00860	0.01010	0.01370
Aluminum > 10 % Si	N		●			228	0.00170	0.00360	0.00580	0.00680	0.00860	0.01010	0.01370

Technical data provided should be considered advisory only as variations may be necessary depending on the particular application.



Micro End Mill Recommended Cutting Data - Slotting

Length	2 Flute Series		3 Flute Series
Standard	121	150	116

Inch - Standard 2-3 Flute

Ball Nose End Mills - If axial depth (ap) is less than the ball diameter, the speed is figured using the effective cutting diameter.

Workpiece Material Group	ISO	Hardness	Coolant			Slotting	End Mill Diameter (Inch)							
			• Preferred	o Possible	x Not Possible			.0150	.0310	.0470	.0620	.0780	.0930	.1250
								14% Dia. ae			35% Dia. ae			
			Max.	Air	MMS			fz - in/tooth						
Free Machining & Low Carbon Steels 1006, 1008, 1015, 1018, 1020, 1022, 1025, 1117, 1140, 1141, 11L08, 11L14, 1213, 12L13, 12L14, 1215, 1330	P	up to 28 Rc	•	•	•	400	.0001	.0001	.0002	.0002	.0003	.0004	.0005	
Medium Carbon & High Carbon Steels, Alloy Steels & Easy to Machine Tool Steels 1030, 1035, 1040, 1045, 1050, 1052, 1055, 1060, 1085, 1095, 1541, 1551, 9255, 2515, 3135, 3415, 4130, 4137, 4140, 4150, 4320, 4340, 4520, 5015, 5115, 5120, 5132, 5140, 5155, 6150, 8620, 9262, 9840, 52100, O1, O2, O6, S2, W1 to W310	P	28 to 38 Rc	•	•	•	300	.0001	.0001	.0002	.0002	.0003	.0003	.0004	
Tool Steels & Die Steels O7, M1, M2, M3, M4, M7, T1, T2, T4, T5, T8, T15, A2, A3, A6, A7, H10, H11, H12, H13, H19, H21, L3, L6, L7, P2, P20, S1, S5, S7, 52100, A 128, D2, D3, D4, D5, D7	P	28 to 44 Rc	•	•	•	200	.0001	.0001	.0002	.0002	.0002	.0003	.0004	
Hardened Steels	H	35-45 Rc	•	o	o	100	.0001	.0001	.0001	.0001	.0001	.0002	.0002	
Stainless Steel - Easy to Machine 430F, 301, 303, 410, 416 Annealed, 420F, 430, 430F	M	up to 28 Rc	•	x	o	400	.0001	.0001	.0002	.0002	.0003	.0004	.0005	
Stainless Steel - Moderately Difficult 301, 302, 303 High Tensile, 304, 304L, 305, 420, 15-5PH, 17-4PH, 17-7PH	M	up to 28 Rc	•	x	o	200	.0001	.0001	.0002	.0002	.0003	.0003	.0004	
Stainless Steel - Difficult to Machine 302B, 304B, 309, 310, 316, 316B, 316L, 316Ti, 317, 317L, 321, PH13-8Mo, Nitronics	M	over 28 Rc	•	x	o	150	.0001	.0001	.0001	.0001	.0002	.0002	.0003	
Cast Iron	K	160-200 HB	•	o	o	400	.0001	.0001	.0002	.0002	.0003	.0004	.0005	
Malleable / Ductile Cast Iron	K	200-250 HB	•	o	o	250	.0001	.0001	.0002	.0002	.0003	.0003	.0004	
High Temp Alloys Nimonic, Inconel, Monel, Hastelloy	S	up to 42 Rc	•	x	x	70	.0001	.0001	.0001	.0001	.0002	.0002	.0003	
Titanium Alloys 6Al-4V, 5Al-2.5 Sn, 6Al-2 Sn-4Zr-6Mo, 3Al-8V-6Cr4Mo-4Zr, 10V-2Fe-3Al, 13V-11Cr-3Al	S	up to 42 Rc	•	x	x	150	.0001	.0001	.0001	.0001	.0002	.0002	.0003	
Aluminum < 10 % Si	N		•			750	.0002	.0003	.0005	.0006	.0007	.0008	.0011	
Aluminum > 10 % Si	N													

Technical data provided should be considered advisory only as variations may be necessary depending on the particular application.



Micro End Mill Recommended Cutting Data - Slotting

Length	2 Flute Series		3 Flute Series
Standard	121	150	116

Metric - Standard 2-3 Flute

Ball Nose End Mills - If axial depth (ap) is less than the ball diameter, the speed is figured using the effective cutting diameter.

Workpiece Material Group	ISO	Hardness	Coolant			Slotting	End Mill Diameter (mm)						
			• Preferred	o Possible	x Not Possible		.4	.8	1.2	1.6	2.0	2.5	3.0
							14% Dia. ae			35% Dia. ae			
			Max.	Air	MMS	vc - m/min Increase speed by 30% for ALtima® coated tools.	fz - mm/tooth						
Free Machining & Low Carbon Steels 1006, 1008, 1015, 1018, 1020, 1022, 1025, 1117, 1140, 1141, 11L08, 11L14, 1213, 12L13, 12L14, 1215, 1330	P	up to 28 Rc	•	•	•	122	.0018	.0033	.0051	.0058	.0074	.0089	.0119
Medium Carbon & High Carbon Steels, Alloy Steels & Easy to Machine Tool Steels 1030, 1035, 1040, 1045, 1050, 1052, 1055, 1060, 1085, 1095, 1541, 1551, 9255, 2515, 3135, 3415, 4130, 4137, 4140, 4150, 4320, 4340, 4520, 5015, 5115, 5120, 5132, 5140, 5155, 6150, 8620, 9262, 9840, 52100, O1, O2, O6, S2, W1 to W310	P	28 to 38 Rc	•	•	•	100	.0015	.0030	.0048	.0053	.0069	.0081	.0109
Tool Steels & Die Steels O7, M1, M2, M3, M4, M7, T1, T2, T4, T5, T8, T15, A2, A3, A6, A7, H10, H11, H12, H13, H19, H21, L3, L6, L7, P2, P20, S1, S5, S7, 52100, A 128, D2, D3, D4, D5, D7	P	28 to 44 Rc	•	•	•	60	.0013	.0028	.0043	.0048	.0061	.0074	.0098
Hardened Steels	H	35-45 Rc	•	o	o	30	.0008	.0015	.0023	.0028	.0033	.0041	.0056
Stainless Steel - Easy to Machine 430F, 301, 303, 410, 416 Annealed, 420F, 430, 430F	M	up to 28 Rc	•	x	o	122	.0018	.0033	.0051	.0058	.0074	.0089	.0119
Stainless Steel - Moderately Difficult 301, 302, 303 High Tensile, 304, 304L, 305, 420, 15-5PH, 17-4PH, 17-7PH	M	up to 28 Rc	•	x	o	61	.0015	.0030	.0048	.0053	.0069	.0081	.0109
Stainless Steel - Difficult to Machine 302B, 304B, 309, 310, 316, 316B, 316L, 316Ti, 317, 317L, 321, PH13-8Mo, Nitronics	M	over 28 Rc	•	x	o	45	.0010	.0020	.0030	.0033	.0043	.0051	.0069
Cast Iron	K	160-200 HB	•	o	o	120	.0018	.0033	.0051	.0058	.0074	.0089	.0119
Malleable / Ductile Cast Iron	K	200-250 HB	•	o	o	76	.0015	.0030	.0048	.0053	.0069	.0081	.0109
High Temp Alloys Nimonic, Inconel, Monel, Hastelloy	S	up to 42 Rc	•	x	x	22	.0010	.0020	.0030	.0033	.0043	.0051	.0069
Titanium Alloys 6Al-4V, 5Al-2.5 Sn, 6Al-2 Sn-4Zr-6Mo, 3Al-8V-6Cr4Mo-4Zr, 10V-2Fe-3Al, 13V-11Cr-3Al	S	up to 42 Rc	•	x	x	45	.0010	.0020	.0030	.0033	.0043	.0051	.0069
Aluminum < 10 % Si	N		•			228	.0038	.0078	.0114	.0139	.0175	.0208	.0279
Aluminum > 10 % Si	N												

Technical data provided should be considered advisory only as variations may be necessary depending on the particular application.



Micro End Mill Recommended Cutting Data - Slotting

Length	2 Flute Series		3 Flute Series
Stub	164	166	169

Inch - Stub Length 2-3 Flute

Ball Nose End Mills - If axial depth (ap) is less than the ball diameter, the speed is figured using the effective cutting diameter.

Workpiece Material Group	ISO	Hardness	Coolant			Slotting	End Mill Diameter (Inch)						
			• Preferred	o Possible	x Not Possible		.0150	.0310	.0470	.0620	.0780	.0930	.1250
							14% Dia. ae			35% Dia. ae			
			Max.	Air	MMS	vc - SFM Increase speed by 30% for ALTIMA® coated tools.	fz - in/tooth						
Free Machining & Low Carbon Steels 1006, 1008, 1015, 1018, 1020, 1022, 1025, 1117, 1140, 1141, 11L08, 11L14, 1213, 12L13, 12L14, 1215, 1330	P	up to 28 Rc	•	•	•	400	.0001	.0002	.0002	.0003	.0003	.0004	.0005
Medium Carbon & High Carbon Steels, Alloy Steels & Easy to Machine Tool Steels 1030, 1035, 1040, 1045, 1050, 1052, 1055, 1060, 1085, 1095, 1541, 1551, 9255, 2515, 3135, 3415, 4130, 4137, 4140, 4150, 4320, 4340, 4520, 5015, 5115, 5120, 5132, 5140, 5155, 6150, 8620, 9262, 9840, 52100, O1, O2, O6, S2, W1 to W310	P	28 to 38 Rc	•	•	•	300	.0001	.0001	.0002	.0002	.0003	.0004	.0005
Tool Steels & Die Steels O7, M1, M2, M3, M4, M7, T1, T2, T4, T5, T8, T15, A2, A3, A6, A7, H10, H11, H12, H13, H19, H21, L3, L6, L7, P2, P20, S1, S5, S7, 52100, A 128, D2, D3, D4, D5, D7	P	28 to 44 Rc	•	•	•	200	.0001	.0001	.0002	.0002	.0002	.0003	.0004
Hardened Steels	H	35-45 Rc	•	o	o	100	.0001	.0001	.0001	.0001	.0001	.0002	.0002
Stainless Steel - Easy to Machine 430F, 301, 303, 410, 416 Annealed, 420F, 430, 430F	M	up to 28 Rc	•	x	o	400	.0001	.0001	.0002	.0002	.0003	.0004	.0005
Stainless Steel - Moderately Difficult 301, 302, 303 High Tensile, 304, 304L, 305, 420, 15-5PH, 17-4PH, 17-7PH	M	up to 28 Rc	•	x	o	200	.0001	.0001	.0002	.0002	.0003	.0003	.0004
Stainless Steel - Difficult to Machine 302B, 304B, 309, 310, 316, 316B, 316L, 316Ti, 317, 317L, 321, PH13-8Mo, Nitronics	M	over 28 Rc	•	x	o	150	.0001	.0001	.0001	.0001	.0002	.0002	.0003
Cast Iron	K	160-200 HB	•	o	o	400	.0001	.0002	.0002	.0003	.0003	.0004	.0005
Malleable / Ductile Cast Iron	K	200-250 HB	•	o	o	250	.0001	.0001	.0002	.0002	.0003	.0004	.0005
High Temp Alloys Nimonics, Inconel, Monel, Hastelloy	S	up to 42 Rc	•	x	x	70	.0001	.0001	.0001	.0001	.0002	.0002	.0003
Titanium Alloys 6Al-4V, 5Al-2.5 Sn, 6Al-2 Sn-4Zr-6Mo, 3Al-8V-6Cr4Mo-4Zr, 10V-2Fe-3Al, 13V-11Cr-3Al	S	up to 42 Rc	•	x	x	150	.0001	.0001	.0001	.0001	.0002	.0002	.0003
Aluminum < 10 % Si	N		•			750	.0002	.0003	.0005	.0006	.0007	.0008	.0011
Aluminum > 10 % Si	N		•										

Technical data provided should be considered advisory only as variations may be necessary depending on the particular application.



Micro End Mill Recommended Cutting Data - Slotting

Length	2 Flute Series		3 Flute Series
Stub	164	166	169

Metric - Stub Length 2-3 Flute

Ball Nose End Mills - If axial depth (ap) is less than the ball diameter, the speed is figured using the effective cutting diameter.

Workpiece Material Group	ISO	Hardness	Coolant			Slotting	End Mill Diameter (mm)												
			● Preferred ○ Possible x Not Possible					.4			.8				1.2	1.6	2.0	2.5	3.0
								14% Dia. ae			35% Dia. ae								
								vc - m/min Increase speed by 30% for ALtima® coated tools.							fz - mm/tooth				
Max.	Air	MMS																	
Free Machining & Low Carbon Steels 1006, 1008, 1015, 1018, 1020, 1022, 1025, 1117, 1140, 1141, 11L08, 11L14, 1213, 12L13, 12L14, 1215, 1330	P	up to 28 Rc	●	●	●	122	.0017	.0038	.0056	.0066	.0081	.0099	.0132						
Medium Carbon & High Carbon Steels, Alloy Steels & Easy to Machine Tool Steels 1030, 1035, 1040, 1045, 1050, 1052, 1055, 1060, 1085, 1095, 1541, 1551, 9255, 2515, 3135, 3415, 4130, 4137, 4140, 4150, 4320, 4340, 4520, 5015, 5115, 5120, 5132, 5140, 5155, 6150, 8620, 9262, 9840, 52100, O1, O2, O6, S2, W1 to W310	P	28 to 38 Rc	●	●	●	100	.0015	.0036	.0053	.0060	.0076	.0089	.0121						
Tool Steels & Die Steels O7, M1, M2, M3, M4, M7, T1, T2, T4, T5, T8, T15, A2, A3, A6, A7, H10, H11, H12, H13, H19, H21, L3, L6, L7, P2, P20, S1, S5, S7, 52100, A 128, D2, D3, D4, D5, D7	P	28 to 44 Rc	●	●	●	60	.0013	.0028	.0043	.0048	.0061	.0074	.0098						
Hardened Steels	H	35-45 Rc	●	○	○	30	.0008	.0015	.0023	.0028	.0033	.0041	.0056						
Stainless Steel - Easy to Machine 430F, 301, 303, 410, 416 Annealed, 420F, 430, 430F	M	up to 28 Rc	●	x	○	122	.0018	.0033	.0051	.0058	.0074	.0089	.0119						
Stainless Steel - Moderately Difficult 301, 302, 303 High Tensile, 304, 304L, 305, 420, 15-5PH, 17-4PH, 17-7PH	M	up to 28 Rc	●	x	○	60	.0015	.0030	.0048	.0053	.0069	.0081	.0109						
Stainless Steel - Difficult to Machine 302B, 304B, 309, 310, 316, 316B, 316L, 316Ti, 317, 317L, 321, PH13-8Mo, Nitronics	M	over 28 Rc	●	x	○	45	.0010	.0020	.0030	.0033	.0043	.0051	.0069						
Cast Iron	K	160-200 HB	●	○	○	120	.0017	.0038	.0055	.0066	.0081	.0099	.0132						
Malleable / Ductile Cast Iron	K	200-250 HB	●	○	○	76	.0015	.0035	.0053	.0060	.0076	.0088	.0121						
High Temp Alloys Nimonic, Inconel, Monel, Hastelloy	S	up to 42 Rc	●	x	x	22	.0010	.0020	.0030	.0033	.0043	.0051	.0069						
Titanium Alloys 6Al-4V, 5Al-2.5 Sn, 6Al-2 Sn-4Zr-6Mo, 3Al-8V-6Cr4Mo-4Zr, 10V-2Fe-3Al, 13V-11Cr-3Al	S	up to 42 Rc	●	x	x	45	.0010	.0020	.0030	.0033	.0043	.0051	.0069						
Aluminum < 10 % Si	N		●			228	.0038	.0078	.0114	.0139	.0175	.0208	.0279						
Aluminum > 10 % Si	N																		

Technical data provided should be considered advisory only as variations may be necessary depending on the particular application.



Micro End Mill Recommended Cutting Data - Slotting

Length	4 Flute Series	
Standard	111	140

Inch - Standard 4 Flute

Ball Nose End Mills - If axial depth (ap) is less than the ball diameter, the speed is figured using the effective cutting diameter.

Workpiece Material Group	ISO	Hardness	Coolant			Slotting	End Mill Diameter (Inch)						
			• Preferred o Possible x Not Possible					.0150	.0310	.0470	.0620	.0780	.0930
						 vc - SFM Increase speed by 30% for ALtima® coated tools.		14% Dia. ae			35% Dia. ae		
			Max.	Air	MMS		fz - in/tooth						
Free Machining & Low Carbon Steels 1006, 1008, 1015, 1018, 1020, 1022, 1025, 1117, 1140, 1141, 11L08, 11L14, 1213, 12L13, 12L14, 1215, 1330	P	up to 28 Rc	•	•	•	400	.0001	.0001	.0002	.0002	.0003	.0004	.0005
Medium Carbon & High Carbon Steels, Alloy Steels & Easy to Machine Tool Steels 1030, 1035, 1040, 1045, 1050, 1052, 1055, 1060, 1085, 1095, 1541, 1551, 9255, 2515, 3135, 3415, 4130, 4137, 4140, 4150, 4320, 4340, 4520, 5015, 5115, 5120, 5132, 5140, 5155, 6150, 8620, 9262, 9840, 52100, O1, O2, O6, S2, W1 to W310	P	28 to 38 Rc	•	•	•	300	.0001	.0001	.0002	.0002	.0003	.0003	.0004
Tool Steels & Die Steels O7, M1, M2, M3, M4, M7, T1, T2, T4, T5, T8, T15, A2, A3, A6, A7, H10, H11, H12, H13, H19, H21, L3, L6, L7, P2, P20, S1, S5, S7, 52100, A 128, D2, D3, D4, D5, D7	P	28 to 44 Rc	•	•	•	200	.0001	.0001	.0002	.0002	.0002	.0003	.0004
Hardened Steels	H	35-45 Rc	•	o	o	100	.0001	.0001	.0001	.0001	.0001	.0002	.0002
Stainless Steel - Easy to Machine 430F, 301, 303, 410, 416 Annealed, 420F, 430, 430F	M	up to 28 Rc	•	x	o	400	.0001	.0001	.0002	.0002	.0003	.0004	.0005
Stainless Steel - Moderately Difficult 301, 302, 303 High Tensile, 304, 304L, 305, 420, 15-5PH, 17-4PH, 17-7PH	M	up to 28 Rc	•	x	o	200	.0001	.0001	.0002	.0002	.0003	.0003	.0004
Stainless Steel - Difficult to Machine 302B, 304B, 309, 310, 316, 316B, 316L, 316Ti, 317, 317L, 321, PH13-8Mo, Nitronics	M	over 28 Rc	•	x	o	150	.0001	.0001	.0001	.0001	.0002	.0002	.0003
Cast Iron	K	160-200 HB	•	o	o	400	.0001	.0001	.0002	.0002	.0003	.0004	.0005
Malleable / Ductile Cast Iron	K	200-250 HB	•	o	o	250	.0001	.0001	.0002	.0002	.0003	.0003	.0004
High Temp Alloys Nimonics, Inconel, Monel, Hastelloy	S	up to 42 Rc	•	x	x	70	.0001	.0001	.0001	.0001	.0002	.0002	.0003
Titanium Alloys 6Al-4V, 5Al-2.5 Sn, 6Al-2 Sn-4Zr-6Mo, 3Al-8V-6Cr4Mo-4Zr, 10V-2Fe-3Al, 13V-11Cr-3Al	S	up to 42 Rc	•	x	x	150	.0001	.0001	.0001	.0001	.0002	.0002	.0003
Aluminum < 10 % Si	N		•			750	.0002	.0003	.0005	.0006	.0007	.0008	.0011
Aluminum > 10 % Si	N												

Technical data provided should be considered advisory only as variations may be necessary depending on the particular application.



Micro End Mill Recommended Cutting Data - Slotting

Length	4 Flute Series	
Standard	111	140

Metric - Standard 4 Flute

Ball Nose End Mills - If axial depth (ap) is less than the ball diameter, the speed is figured using the effective cutting diameter.

Workpiece Material Group	ISO	Hardness	Coolant			Slotting	End Mill Diameter (mm)						
			• Preferred	o Possible	x Not Possible		.4	.8	1.2	1.6	2.0	2.5	3.0
							14% Dia. ae			35% Dia. ae			
			Max.	Air	MMS	vc - m/min Increase speed by 30% for ALtima® coated tools.	fz - mm/tooth						
Free Machining & Low Carbon Steels 1006, 1008, 1015, 1018, 1020, 1022, 1025, 1117, 1140, 1141, 11L08, 11L14, 1213, 12L13, 12L14, 1215, 1330	P	up to 28 Rc	•	•	•	122	.0018	.0033	.0051	.0058	.0074	.0089	.0119
Medium Carbon & High Carbon Steels, Alloy Steels & Easy to Machine Tool Steels 1030, 1035, 1040, 1045, 1050, 1052, 1055, 1060, 1085, 1095, 1541, 1551, 9255, 2515, 3135, 3415, 4130, 4137, 4140, 4150, 4320, 4340, 4520, 5015, 5115, 5120, 5132, 5140, 5155, 6150, 8620, 9262, 9840, 52100, O1, O2, O6, S2, W1 to W310	P	28 to 38 Rc	•	•	•	100	.0015	.0030	.0048	.0053	.0069	.0081	.0109
Tool Steels & Die Steels O7, M1, M2, M3, M4, M7, T1, T2, T4, T5, T8, T15, A2, A3, A6, A7, H10, H11, H12, H13, H19, H21, L3, L6, L7, P2, P20, S1, S5, S7, 52100, A 128, D2, D3, D4, D5, D7	P	28 to 44 Rc	•	•	•	60	.0013	.0028	.0043	.0048	.0061	.0074	.0098
Hardened Steels	H	35-45 Rc	•	o	o	30	.0008	.0015	.0023	.0028	.0033	.0041	.0056
Stainless Steel - Easy to Machine 430F, 301, 303, 410, 416 Annealed, 420F, 430, 430F	M	up to 28 Rc	•	x	o	122	.0018	.0033	.0051	.0058	.0074	.0089	.0119
Stainless Steel - Moderately Difficult 301, 302, 303 High Tensile, 304, 304L, 305, 420, 15-5PH, 17-4PH, 17-7PH	M	up to 28 Rc	•	x	o	60	.0015	.0030	.0048	.0053	.0069	.0081	.0109
Stainless Steel - Difficult to Machine 302B, 304B, 309, 310, 316, 316B, 316L, 316Ti, 317, 317L, 321, PH13-8Mo, Nitronics	M	over 28 Rc	•	x	o	45	.0010	.0020	.0030	.0033	.0043	.0051	.0069
Cast Iron	K	160-200 HB	•	o	o	120	.0018	.0033	.0051	.0058	.0074	.0089	.0119
Malleable / Ductile Cast Iron	K	200-250 HB	•	o	o	76	.0015	.0030	.0048	.0053	.0069	.0081	.0109
High Temp Alloys Nimonic, Inconel, Monel, Hastelloy	S	up to 42 Rc	•	x	x	22	.0010	.0020	.0030	.0033	.0043	.0051	.0069
Titanium Alloys 6Al-4V, 5Al-2.5 Sn, 6Al-2 Sn-4Zr-6Mo, 3Al-8V-6Cr4Mo-4Zr, 10V-2Fe-3Al, 13V-11Cr-3Al	S	up to 42 Rc	•	x	x	45	.0010	.0020	.0030	.0033	.0043	.0051	.0069
Aluminum < 10 % Si	N		•			228	.0038	.0078	.0114	.0139	.0175	.0208	.0279
Aluminum > 10 % Si	N		•										

Technical data provided should be considered advisory only as variations may be necessary depending on the particular application.





Micro End Mill Recommended Cutting Data - Slotting

Length	4 Flute Series	
Stub	163	165

Inch - Stub Length 4 Flute

Ball Nose End Mills - If axial depth (ap) is less than the ball diameter, the speed is figured using the effective cutting diameter.

Workpiece Material Group	ISO	Hardness	Coolant			Slotting	End Mill Diameter (Inch)						
			• Preferred o Possible x Not Possible					.0150	.0310	.0470	.0620	.0780	.0930
						14% Dia. ae			35% Dia. ae				
			Max.	Air	MMS	fz - in/tooth							
Free Machining & Low Carbon Steels 1006, 1008, 1015, 1018, 1020, 1022, 1025, 1117, 1140, 1141, 11L08, 11L14, 1213, 12L13, 12L14, 1215, 1330	P	up to 28 Rc	•	•	•	400	.0001	.0001	.0002	.0002	.0003	.0004	.0005
Medium Carbon & High Carbon Steels, Alloy Steels & Easy to Machine Tool Steels 1030, 1035, 1040, 1045, 1050, 1052, 1055, 1060, 1085, 1095, 1541, 1551, 9255, 2515, 3135, 3415, 4130, 4137, 4140, 4150, 4320, 4340, 4520, 5015, 5115, 5120, 5132, 5140, 5155, 6150, 8620, 9262, 9840, 52100, O1, O2, O6, S2, W1 to W310	P	28 to 38 Rc	•	•	•	300	.0001	.0001	.0002	.0002	.0003	.0003	.0004
Tool Steels & Die Steels O7, M1, M2, M3, M4, M7, T1, T2, T4, T5, T8, T15, A2, A3, A6, A7, H10, H11, H12, H13, H19, H21, L3, L6, L7, P2, P20, S1, S5, S7, 52100, A 128, D2, D3, D4, D5, D7	P	28 to 44 Rc	•	•	•	200	.0001	.0001	.0002	.0002	.0002	.0003	.0004
Hardened Steels	H	35-45 Rc	•	o	o	100	.0001	.0001	.0001	.0001	.0001	.0002	.0002
Stainless Steel - Easy to Machine 430F, 301, 303, 410, 416 Annealed, 420F, 430, 430F	M	up to 28 Rc	•	x	o	400	.0001	.0001	.0002	.0002	.0003	.0004	.0005
Stainless Steel - Moderately Difficult 301, 302, 303 High Tensile, 304, 304L, 305, 420, 15-5PH, 17-4PH, 17-7PH	M	up to 28 Rc	•	x	o	200	.0001	.0001	.0002	.0002	.0003	.0003	.0004
Stainless Steel - Difficult to Machine 302B, 304B, 309, 310, 316, 316B, 316L, 316Ti, 317, 317L, 321, PH13-8Mo, Nitronics	M	over 28 Rc	•	x	o	150	.0001	.0001	.0001	.0001	.0002	.0002	.0003
Cast Iron	K	160-200 HB	•	o	o	400	.0001	.0001	.0002	.0002	.0003	.0004	.0005
Malleable / Ductile Cast Iron	K	200-250 HB	•	o	o	250	.0001	.0001	.0002	.0002	.0003	.0003	.0004
High Temp Alloys Nimonic, Inconel, Monel, Hastelloy	S	up to 42 Rc	•	x	x	70	.0001	.0001	.0001	.0001	.0002	.0002	.0003
Titanium Alloys 6Al-4V, 5Al-2.5 Sn, 6Al-2 Sn-4Zr-6Mo, 3Al-8V-6Cr-4Mo-4Zr, 10V-2Fe-3Al, 13V-11Cr-3Al	S	up to 42 Rc	•	x	x	150	.0001	.0001	.0001	.0001	.0002	.0002	.0003
Aluminum < 10 % Si	N		•			750	.0002	.0003	.0005	.0006	.0007	.0008	.0011
Aluminum > 10 % Si	N		•										

Technical data provided should be considered advisory only as variations may be necessary depending on the particular application.



Micro End Mill Recommended Cutting Data - Slotting

Length	4 Flute Series	
Stub	163	165

Metric - Stub Length 4 Flute

Ball Nose End Mills - If axial depth (ap) is less than the ball diameter, the speed is figured using the effective cutting diameter.

Workpiece Material Group	ISO	Hardness	Coolant			Slotting	End Mill Diameter (mm)							
			● Preferred		○ Possible		vc - m/min Increase speed by 30% for ALtima® coated tools.	14% Dia. ae			35% Dia. ae			
			Max.	Air	MMS			fz - mm/tooth	.4	.8	1.2	1.6	2.0	2.5
Free Machining & Low Carbon Steels 1006, 1008, 1015, 1018, 1020, 1022, 1025, 1117, 1140, 1141, 11L08, 11L14, 1213, 12L13, 12L14, 1215, 1330	P	up to 28 Rc	●	●	●	122	.0018	.0033	.0051	.0058	.0074	.0089	.0119	
Medium Carbon & High Carbon Steels, Alloy Steels & Easy to Machine Tool Steels 1030, 1035, 1040, 1045, 1050, 1052, 1055, 1060, 1085, 1095, 1541, 1551, 9255, 2515, 3135, 3415, 4130, 4137, 4140, 4150, 4320, 4340, 4520, 5015, 5115, 5120, 5132, 5140, 5155, 6150, 8620, 9262, 9840, 52100, O1, O2, O6, S2, W1 to W310	P	28 to 38 Rc	●	●	●	100	.0015	.0030	.0048	.0053	.0069	.0081	.0109	
Tool Steels & Die Steels O7, M1, M2, M3, M4, M7, T1, T2, T4, T5, T8, T15, A2, A3, A6, A7, H10, H11, H12, H13, H19, H21, L3, L6, L7, P2, P20, S1, S5, S7, 52100, A 128, D2, D3, D4, D5, D7	P	28 to 44 Rc	●	●	●	60	.0013	.0028	.0043	.0048	.0061	.0074	.0098	
Hardened Steels	H	35-45 Rc	●	○	○	30	.0008	.0015	.0023	.0028	.0033	.0041	.0056	
Stainless Steel - Easy to Machine 430F, 301, 303, 410, 416 Annealed, 420F, 430, 430F	M	up to 28 Rc	●	x	○	122	.0018	.0033	.0051	.0058	.0074	.0089	.0119	
Stainless Steel - Moderately Difficult 301, 302, 303 High Tensile, 304, 304L, 305, 420, 15-5PH, 17-4PH, 17-7PH	M	up to 28 Rc	●	x	○	60	.0015	.0030	.0048	.0053	.0069	.0081	.0109	
Stainless Steel - Difficult to Machine 302B, 304B, 309, 310, 316, 316B, 316L, 316Ti, 317, 317L, 321, PH13-8Mo, Nitronics	M	over 28 Rc	●	x	○	45	.0010	.0020	.0030	.0033	.0043	.0051	.0069	
Cast Iron	K	160-200 HB	●	○	○	120	.0018	.0033	.0051	.0058	.0074	.0089	.0119	
Malleable / Ductile Cast Iron	K	200-250 HB	●	○	○	76	.0015	.0030	.0048	.0053	.0069	.0081	.0109	
High Temp Alloys Nimonic, Inconel, Monel, Hastelloy	S	up to 42 Rc	●	x	x	22	.0010	.0020	.0030	.0033	.0043	.0051	.0069	
Titanium Alloys 6Al-4V, 5Al-2.5 Sn, 6Al-2 Sn-4Zr-6Mo, 3Al-8V-6Cr4Mo-4Zr, 10V-2Fe-3Al, 13V-11Cr-3Al	S	up to 42 Rc	●	x	x	45	.0010	.0020	.0030	.0033	.0043	.0051	.0069	
Aluminum < 10 % Si	N		●			228	.0038	.0078	.0114	.0139	.0175	.0208	.0279	
Aluminum > 10 % Si	N													

Technical data provided should be considered advisory only as variations may be necessary depending on the particular application.

TrueSize® Reamers

Solid Carbide TrueSize® Reamers
Deliver High-Precision Hole Finishes

In applications that require high-precision hole finishes, or tighter diameter control, M.A. Ford® True Size® Reamers can be used with confidence. Solid Carbide Reamers are available in a wide range of sizes for virtually all materials, including cast iron, aluminum, stainless steel, exotic alloys, plastics and other non-ferrous materials.

Complete Family of Standard and Metric Sizes

M.A. Ford® stocks over 900 inch and metric size reamers in its product line, ranging from .013 inch to 16mm diameter. Visit www.maford.com to see the complete offering. These products are available for immediate shipment. M.A. Ford® also maintains an inventory of pre-finished blanks, which can be finished to your precise specifications and shipped within 72 hours upon request. See Rapid Turn Around Service on page 138 for more information.

Material Removal Parameters

For proper finishing with a reamer, the correct amount of material must be left in the hole. If the hole is too close to the finish size, the reamer will tend to burnish the hole, and excessive tool wear will occur. If too much material is left, chips can clog the flutes of the reamer, resulting in a poor finish, poor size control, and possible tool breakage.

Refer to chart Total Stock Allowance on pages 150-151 as a starting point for reaming operations.



TrueSize® XP = Xtreme Precision 270P Straight Flute

One week turnaround on 270P orders.
(25 piece max.)

All M.A. Ford® Reamers
are ground between
centers to assure
maximum concentricity.

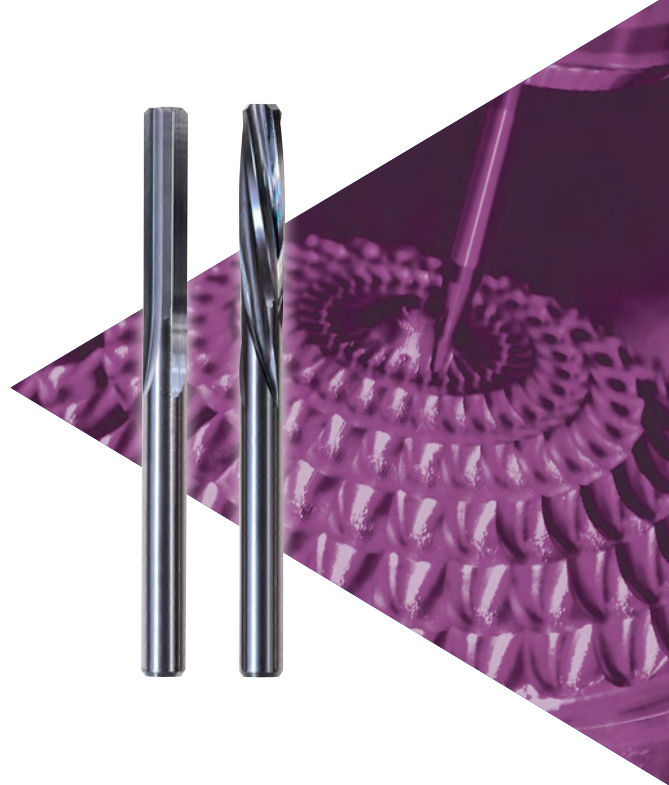

	Page
TrueSize® Reamers Series 270 / 270L	138
TrueSize® Reamers Series 270P	140

	Page
TrueSize® Reamers Series 272	141
Technical Information	149-153

TrueSize® Carbide Range Reamer Straight Flute Series 270

TrueSize® Carbide Range Reamer Left Hand Spiral Series 270L

Series 270 / 270L

TrueSize®

4
Flute

MICRO Reamers



Before you order a 270 Series - check our listing of standard diameters in the 272 Series.



Competitors special sizes are our standards!

Recommended for general purpose reaming in most materials. Kept in stock as a semi-finished tool. When orders are received tools can be promptly finish ground to the desired diameter. Specify size when ordering.

- Right hand cutting
- 45° lead cutting angle



Need a Reamer Fast?

**Request Rapid Turn
Around Service.
Straight Flute sizes above
.0433" (1.10mm)
Contact Customer Service
For Delivery Times**

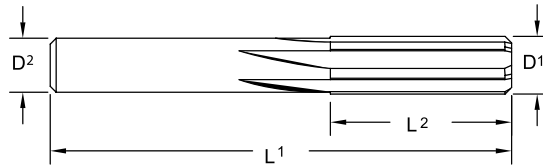

Inch	
D1	Tolerance
≤ 3/8	+ .0001 / + .0003
D2	Tolerance
≤ 3/8	+ .000 / - .001
L1	Tolerance
≤ 3/8	+ / - 1/16
L2	Tolerance
≤ 3/8	+ / - 1/16

Metric (mm)	
D1	Tolerance
≤ 9.52	+ .0025 / + .0076
D2	Tolerance
0.35 - 3.15	+0 / -0.03
L1	Tolerance
0.35 - 3.15	+ / - 1.5
L2	Tolerance
0.35 - 3.15	+ / - 1.5





Series 270 / 270L

Series 270		Series 270L		D2		L1		L2		Flutes	
D1 Diameter				Shank		OAL		Flute Length			
Inch	mm	Inch	mm	Inch	mm	Inch	mm	Inch	mm		
.0135-.0200	00.34-0.50	.0135-.0200	00.34-0.50	.0135-.0433 are no longer a standard item. Contact customer service for price and availability as a special quoted item. 800-553-8024 or 563-391-6220							
.0201-.0400	00.51-1.01	.0201-.0400	00.51-1.01								
.0401-.0433	01.02-1.09	.0401-.0433	01.02-1.09								
.0434-.0519	01.10-1.31	.0434-.0519	01.10-1.31	.043	1.09	1-1/2	38	3/8	9.5	4	
.0520-.0590	01.32-1.49	.0520-.0590	01.32-1.49	.046	1.17	1-1/2	38	3/8	9.5	4	
.0591-.0660	01.50-1.67	.0591-.0660	01.50-1.67	.058	1.47	1-1/2	38	3/8	9.5	4	
.0661-.0740	01.68-1.87	.0661-.0740	01.68-1.87	.065	1.65	1-3/4	44	1/2	12.5	4	
.0741-.0810	01.88-2.05	.0741-.0810	01.88-2.05	.073	1.85	1-3/4	44	1/2	12.5	4	
.0811-.0890	02.06-2.26	.0811-.0890	02.06-2.26	.080	2.03	2	51	1/2	12.5	4	
.0891-.0970	02.27-2.46	.0891-.0970	02.27-2.46	.088	2.24	2	51	1/2	12.5	4	
.0971-.1050	02.47-2.66	.0971-.1050	02.47-2.66	.096	2.44	2-1/4	57	5/8	16	4	
.1051-.1130	02.67-2.87	.1051-.1130	02.67-2.87	.104	2.64	2-1/4	57	5/8	16	4	
.1131-.1210	02.88-3.07	.1131-.1210	02.88-3.07	.112	2.84	2-1/4	57	5/8	16	4	
.1211-.1280	03.08-3.25	.1211-.1280	03.08-3.25	.120	3.05	2-1/4	57	5/8	16	4	

See full line catalog for complete offering.



Page 152

Carbide Range Reamer Precision Tolerance OD Series 270P

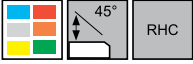

**TrueSize® XP = Xtreme Precision
270P Straight Flute**

- Recommended for precision reaming in most materials
- Kept in stock as a semi-finished tool
When orders are received tools can be promptly finish ground to the desired diameter. 1 week turn around (25 piece order maximum)
- Specify size when ordering
- Right hand cutting
- 45° lead cutting angle

Series 270P

TrueSize®

4
Flute

MICRO Reamers

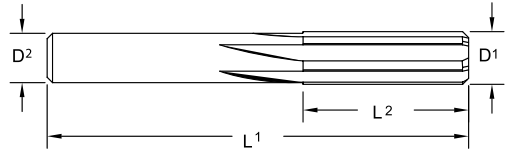

Series 270P		D2		L1		L2		Flutes
D1 Diameter		Shank		OAL		Flute Length		
Inch	mm	Inch	mm	Inch	mm	Inch	mm	
.0434-.0519	01.10-1.31	.043	1.09	1-1/2	38	3/8	9.5	4
.0520-.0590	01.32-1.49	.046	1.17	1-1/2	38	3/8	9.5	4
.0591-.0660	01.50-1.67	.058	1.47	1-1/2	38	3/8	9.5	4
.0661-.0740	01.68-1.87	.065	1.65	1-3/4	44	1/2	12.5	4
.0741-.0810	01.88-2.05	.073	1.85	1-3/4	44	1/2	12.5	4
.0811-.0890	02.06-2.26	.080	2.03	2	51	1/2	12.5	4
.0891-.0970	02.27-2.46	.088	2.24	2	51	1/2	12.5	4
.0971-.1050	02.47-2.66	.096	2.44	2-1/4	57	5/8	16	4
.1051-.1130	02.67-2.87	.104	2.64	2-1/4	57	5/8	16	4
.1131-.1210	02.88-3.07	.112	2.84	2-1/4	57	5/8	16	4
.1211-.1280	03.08-3.25	.120	3.05	2-1/4	57	5/8	16	4

Inch	
D1	Tolerance
.0434 - .1250	+0.0001/+0.0000
D2	Tolerance
.0434 - .1250	+0.000/-0.001
L1/L2	Tolerance
.0434 - .1250	+/- 1/16



See full line catalog for complete offering.



Carbide Reamer Series 272

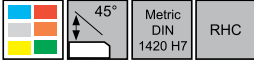

- Recommended for general purpose reaming.
- Straight flutes.
- Well suited for most materials.
- Special sizes, shank diameters, flute lengths, step reamers, coating, etc. available as specials. Call Customer Service at 800-553-8024 for a quote.

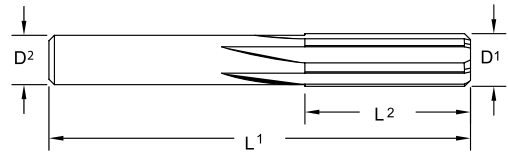

Inch	
D1	Tolerance
≤ 3/8	+0.001/+0.003
D2	Tolerance
≤ 3/8	+0.000/-0.001
L1/L2	Tolerance
≤ 3/8	+/- 1/16

Metric (mm)	
D1	Tolerance
0.35 - 3.15	DIN1420 H7
D2	Tolerance
0.35 - 3.15	+0.00/-0.03
L1/L2	Tolerance
0.35 - 3.15	+/- 1.5

DIN1420 H7	
D1	Tolerance
≤ 3mm	+0.004/+0.008
>3mm - 6mm	+0.005/+0.010



Page 152

If you don't see the size you need - Just Ask
Most special sizes shipped within 72 hours upon request.

See full line catalog or visit www.maford.com for complete offering.



Series 272

Tool No.	EDP	Diameter				Shank		OAL		Flute Length		Flutes
		D1				D2		L1		L2		
		Inch	Wire	mm	Decimal	Inch	mm	Inch	mm	Inch	mm	
27201300	03000	-	-	-	0.0130	0.0130	-	1-1/2	-	3/16	-	4
27201350	01001	-	80	-	0.0135	0.0135	-	1-1/2	-	3/16	-	4
27201380	01005	-	-	0.35	0.0138	0.0138	0.35	-	38	-	5.0	4
27201400	03001	-	-	-	0.0140	0.0140	-	1-1/2	-	3/16	-	4
27201450	01009	-	79	-	0.0145	0.0145	-	1-1/2	-	3/16	-	4
27201500	03002	-	-	-	0.0150	0.0150	-	1-1/2	-	3/16	-	4
27201550	03003	-	-	-	0.0155	0.0155	-	1-1/2	-	3/16	-	4
27201560	01013	1/64	-	-	0.0156	0.0156	-	1-1/2	-	3/16	-	4
27201570	01017	-	-	0.40	0.0157	0.0157	0.40	-	38	-	5.0	4
27201600	01021	-	78	-	0.0160	0.0160	-	1-1/2	-	3/16	-	4
27201650	03004	-	-	-	0.0165	0.0165	-	1-1/2	-	3/16	-	4
27201700	03005	-	-	-	0.0170	0.0170	-	1-1/2	-	3/16	-	4
27201750	03006	-	-	-	0.0175	0.0175	-	1-1/2	-	3/16	-	4
27201770	01025	-	-	0.45	0.0177	0.0177	0.45	-	38	-	5.0	4
27201800	01029	-	77	-	0.0180	0.0180	-	1-1/2	-	3/16	-	4
27201850	03007	-	-	-	0.0185	0.0185	-	1-1/2	-	3/16	-	4
27201900	03008	-	-	-	0.0190	0.0190	-	1-1/2	-	3/16	-	4
27201950	03009	-	-	-	0.0195	0.0195	-	1-1/2	-	3/16	-	4
27201970	01033	-	-	0.50	0.0197	0.0197	0.50	-	38	-	5.0	4
27202000	01037	-	76	-	0.0200	0.0200	-	1-1/2	-	3/16	-	4
27202050	03010	-	-	-	0.0205	0.0205	-	1-1/2	-	1/4	-	4
27202100	01041	-	75	-	0.0210	0.0210	-	1-1/2	-	1/4	-	4
27202150	03011	-	-	-	0.0215	0.0215	-	1-1/2	-	1/4	-	4
27202170	01045	-	-	0.55	0.0217	0.0217	0.55	-	38	-	6.5	4
27202200	03012	-	-	-	0.0220	0.0220	-	1-1/2	-	1/4	-	4
27202250	01049	-	74	-	0.0225	0.0225	-	1-1/2	-	1/4	-	4
27202300	03013	-	-	-	0.0230	0.0230	-	1-1/2	-	1/4	-	4
27202350	03014	-	-	-	0.0235	0.0235	-	1-1/2	-	1/4	-	4
27202360	01053	-	-	0.60	0.0236	0.0236	0.60	-	38	-	6.5	4
27202400	01057	-	73	-	0.0240	0.0240	-	1-1/2	-	1/4	-	4
27202450	03015	-	-	-	0.0245	0.0245	-	1-1/2	-	1/4	-	4
27202500	01061	-	72	-	0.0250	0.0250	-	1-1/2	-	1/4	-	4
27202550	03016	-	-	-	0.0255	0.0255	-	1-1/2	-	1/4	-	4
27202560	01065	-	-	0.65	0.0256	0.0256	0.65	-	38	-	6.5	4
27202600	01069	-	71	-	0.0260	0.0260	-	1-1/2	-	1/4	-	4
27202650	03017	-	-	-	0.0265	0.0265	-	1-1/2	-	1/4	-	4
27202700	03018	-	-	-	0.0270	0.0270	-	1-1/2	-	1/4	-	4
27202750	03019	-	-	-	0.0275	0.0275	-	1-1/2	-	1/4	-	4
27202760	01073	-	-	0.70	0.0276	0.0276	0.70	-	38	-	6.5	4
27202800	01077	-	70	-	0.0280	0.0280	-	1-1/2	-	1/4	-	4
27202850	03020	-	-	-	0.0285	0.0285	-	1-1/2	-	1/4	-	4
27202900	03021	-	-	-	0.0290	0.0290	-	1-1/2	-	1/4	-	4

Series 272

TrueSize®

MICRO Reamers

4 Flute



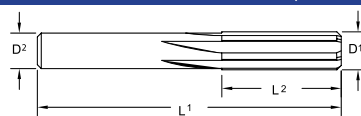

Series 272 Continued

Tool No.	EDP	Diameter				Shank		OAL		Flute Length		Flutes
		D1				D2		L1		L2		
		Inch	Wire	mm	Decimal	Inch	mm	Inch	mm	Inch	mm	
27202920	01081	-	69	-	0.0292	0.0292	-	1-1/2	-	1/4	-	4
27202950	01085	-	-	0.75	0.0295	0.0295	0.75	-	38	-	6.5	4
27202951	03620	-	-	-	0.0295	0.0295	-	1-1/2	-	1/4	-	4
27203000	03022	-	-	-	0.0300	0.0300	-	1-1/2	-	1/4	-	4
27203050	03023	-	-	-	0.0305	0.0305	-	1-1/2	-	1/4	-	4
27203100	01089	-	68	-	0.0310	0.0310	-	1-1/2	-	1/4	-	4
27203120	01093	1/32	-	-	0.0312	0.0312	-	1-1/2	-	1/4	-	4
27203150	01097	-	-	0.80	0.0315	0.0315	0.80	-	38	-	6.5	4
27203151	03621	-	-	-	0.0315	0.0315	-	1-1/2	-	1/4	-	4
27203200	01101	-	67	-	0.0320	0.0320	-	1-1/2	-	1/4	-	4
27203250	03024	-	-	-	0.0325	0.0325	-	1-1/2	-	1/4	-	4
27203300	01105	-	66	-	0.0330	0.0330	-	1-1/2	-	1/4	-	4
27203350	01109	-	-	0.85	0.0335	0.0335	0.85	-	38	-	6.5	4
27203351	03622	-	-	-	0.0335	0.0335	-	1-1/2	-	1/4	-	4
27203400	03025	-	-	-	0.0340	0.0340	-	1-1/2	-	1/4	-	4
27203450	03026	-	-	-	0.0345	0.0345	-	1-1/2	-	1/4	-	4
27203500	01113	-	65	-	0.0350	0.0350	-	1-1/2	-	1/4	-	4
27203540	01117	-	-	0.90	0.0354	0.0354	0.90	-	38	-	6.5	4
27203550	03027	-	-	-	0.0355	0.0355	-	1-1/2	-	1/4	-	4
27203600	01121	-	64	-	0.0360	0.0360	-	1-1/2	-	1/4	-	4
27203650	03028	-	-	-	0.0365	0.0365	-	1-1/2	-	1/4	-	4
27203700	01125	-	63	-	0.0370	0.0370	-	1-1/2	-	1/4	-	4
27203740	01129	-	-	0.95	0.0374	0.0374	0.95	-	38	-	6.5	4
27203750	03029	-	-	-	0.0375	0.0375	-	1-1/2	-	1/4	-	4
27203800	01133	-	62	-	0.0380	0.0380	-	1-1/2	-	1/4	-	4
27203850	03030	-	-	-	0.0385	0.0385	-	1-1/2	-	1/4	-	4
27203900	01137	-	61	-	0.0390	0.0390	-	1-1/2	-	1/4	-	4
27203940	01141	-	-	1.00	0.0394	0.0394	1.00	-	38	-	6.5	4
27203950	03031	-	-	-	0.0395	0.0395	-	1-1/2	-	1/4	-	4
27204000	01145	-	60	-	0.0400	0.0400	-	1-1/2	-	1/4	-	4
27204050	03032	-	-	-	0.0405	0.0405	-	1-1/2	-	3/8	-	4
27204100	01149	-	59	-	0.0410	0.0410	-	1-1/2	-	3/8	-	4
27204130	01153	-	-	1.05	0.0413	0.0413	1.05	-	38	-	9.5	4
27204150	03033	-	-	-	0.0415	0.0415	-	1-1/2	-	3/8	-	4
27204200	01157	-	58	-	0.0420	0.0420	-	1-1/2	-	3/8	-	4
27204250	03034	-	-	-	0.0425	0.0425	-	1-1/2	-	3/8	-	4
27204300	01161	-	57	-	0.0430	0.0430	-	1-1/2	-	3/8	-	4
27204330	01165	-	-	1.10	0.0433	0.0433	1.10	-	38	-	9.5	4
27204350	03035	-	-	-	0.0435	0.0430	-	1-1/2	-	3/8	-	4
27204400	03036	-	-	-	0.0440	0.0430	-	1-1/2	-	3/8	-	4
27204450	03037	-	-	-	0.0445	0.0430	-	1-1/2	-	3/8	-	4
27204500	03038	-	-	-	0.0450	0.0430	-	1-1/2	-	3/8	-	4





Series 272 Continued

Tool No.	EDP	Diameter				Shank		OAL		Flute Length		Flutes
		D1				D2		L1		L2		
		Inch	Wire	mm	Decimal	Inch	mm	Inch	mm	Inch	mm	
27204520	01169	-	-	1.15	0.0452	0.0430	1.09	-	38	-	9.5	4
27204550	03039	-	-	-	0.0455	0.0430	-	1-1/2	-	3/8	-	4
27204600	03040	-	-	-	0.0460	0.0430	-	1-1/2	-	3/8	-	4
27204650	01173	-	56	-	0.0465	0.0430	-	1-1/2	-	3/8	-	4
27204680	01177	3/64	-	-	0.0468	0.0430	-	1-1/2	-	3/8	-	4
27204700	03041	-	-	-	0.0470	0.0430	-	1-1/2	-	3/8	-	4
27204720	01181	-	-	1.20	0.0472	0.0430	1.09	-	38	-	9.5	4
27204750	03042	-	-	-	0.0475	0.0430	-	1-1/2	-	3/8	-	4
27204800	03043	-	-	-	0.0480	0.0430	-	1-1/2	-	3/8	-	4
27204850	03044	-	-	-	0.0485	0.0430	-	1-1/2	-	3/8	-	4
27204900	03045	-	-	-	0.0490	0.0430	-	1-1/2	-	3/8	-	4
27204920	01185	-	-	1.25	0.0492	0.0430	1.09	-	38	-	9.5	4
27204950	03046	-	-	-	0.0495	0.0430	-	1-1/2	-	3/8	-	4
27205000	03047	-	-	-	0.0500	0.0430	-	1-1/2	-	3/8	-	4
27205050	03048	-	-	-	0.0505	0.0430	-	1-1/2	-	3/8	-	4
27205100	03049	-	-	-	0.0510	0.0430	-	1-1/2	-	3/8	-	4
27205110	01189	-	-	1.30	0.0511	0.0430	1.09	-	38	-	9.5	4
27205150	03050	-	-	-	0.0515	0.0430	-	1-1/2	-	3/8	-	4
27205200	01193	-	55	-	0.0520	0.0460	-	1-1/2	-	3/8	-	4
27205250	03051	-	-	-	0.0525	0.0460	-	1-1/2	-	3/8	-	4
27205300	03052	-	-	-	0.0530	0.0460	-	1-1/2	-	3/8	-	4
27205310	01197	-	-	1.35	0.0531	0.0460	1.17	-	38	-	9.5	4
27205350	03053	-	-	-	0.0535	0.0460	-	1-1/2	-	3/8	-	4
27205400	03054	-	-	-	0.0540	0.0460	-	1-1/2	-	3/8	-	4
27205450	03055	-	-	-	0.0545	0.0460	-	1-1/2	-	3/8	-	4
27205500	01201	-	54	-	0.0550	0.0460	-	1-1/2	-	3/8	-	4
27205510	01205	-	-	1.40	0.0551	0.0460	1.17	-	38	-	9.5	4
27205550	03056	-	-	-	0.0555	0.0460	-	1-1/2	-	3/8	-	4
27205600	03057	-	-	-	0.0560	0.0460	-	1-1/2	-	3/8	-	4
27205650	03058	-	-	-	0.0565	0.0460	-	1-1/2	-	3/8	-	4
27205700	03059	-	-	-	0.0570	0.0460	-	1-1/2	-	3/8	-	4
27205710	01209	-	-	1.45	0.0571	0.0460	1.17	-	38	-	9.5	4
27205750	03060	-	-	-	0.0575	0.0460	-	1-1/2	-	3/8	-	4
27205800	03061	-	-	-	0.0580	0.0460	-	1-1/2	-	3/8	-	4
27205850	03062	-	-	-	0.0585	0.0460	-	1-1/2	-	3/8	-	4
27205900	01213	-	-	1.50	0.0590	0.0460	1.17	-	38	-	9.5	4
27205901	03623	-	-	-	0.0590	0.0460	-	1-1/2	-	3/8	-	4
27205950	01217	-	53	-	0.0595	0.0580	-	1-1/2	-	3/8	-	4
27206000	03063	-	-	-	0.0600	0.0580	-	1-1/2	-	3/8	-	4
27206050	03064	-	-	-	0.0605	0.0580	-	1-1/2	-	3/8	-	4
27206100	01221	-	-	1.55	0.0610	0.0580	1.47	-	38	-	9.5	4
27206101	03624	-	-	-	0.0610	0.0580	-	1-1/2	-	3/8	-	4

Series 272

TrueSize®

MICRO Reamers



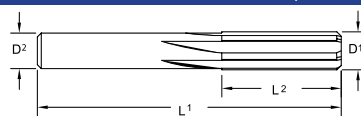

Series 272 Continued

Tool No.	EDP	Diameter				Shank		OAL		Flute Length		Flutes
		D1				D2		L1		L2		
		Inch	Wire	mm	Decimal	Inch	mm	Inch	mm	Inch	mm	
27206150	03065	-	-	-	0.0615	0.0580	-	1-1/2	-	3/8	-	4
27206200	03066	-	-	-	0.0620	0.0580	-	1-1/2	-	3/8	-	4
27206250	01225	1/16	-	-	0.0625	0.0580	-	1-1/2	-	3/8	-	4
27206300	01229	-	-	1.60	0.0630	0.0580	1.47	-	38	-	9.5	4
27206301	03625	-	-	-	0.0630	0.0580	-	1-1/2	-	3/8	-	4
27206350	01233	-	52	-	0.0635	0.0580	-	1-1/2	-	3/8	-	4
27206400	03067	-	-	-	0.0640	0.0580	-	1-1/2	-	3/8	-	4
27206450	03068	-	-	-	0.0645	0.0580	-	1-1/2	-	3/8	-	4
27206490	01237	-	-	1.65	0.0649	0.0580	1.47	-	38	-	9.5	4
27206500	03069	-	-	-	0.0650	0.0580	-	1-1/2	-	3/8	-	4
27206550	03070	-	-	-	0.0655	0.0580	-	1-1/2	-	3/8	-	4
27206600	03071	-	-	-	0.0660	0.0580	-	1-1/2	-	3/8	-	4
27206650	03072	-	-	-	0.0665	0.0650	-	1-3/4	-	1/2	-	4
27206690	01241	-	-	1.70	0.0669	0.0650	1.65	-	44	-	12.5	4
27206700	01245	-	51	-	0.0670	0.0650	-	1-3/4	-	1/2	-	4
27206750	03073	-	-	-	0.0675	0.0650	-	1-3/4	-	1/2	-	4
27206800	03074	-	-	-	0.0680	0.0650	-	1-3/4	-	1/2	-	4
27206850	03075	-	-	-	0.0685	0.0650	-	1-3/4	-	1/2	-	4
27206890	01249	-	-	1.75	0.0689	0.0650	1.65	-	44	-	12.5	4
27206900	03076	-	-	-	0.0690	0.0650	-	1-3/4	-	1/2	-	4
27206950	03077	-	-	-	0.0695	0.0650	-	1-3/4	-	1/2	-	4
27207000	01253	-	50	-	0.0700	0.0650	-	1-3/4	-	1/2	-	4
27207050	03078	-	-	-	0.0705	0.0650	-	1-3/4	-	1/2	-	4
27207080	01257	-	-	1.80	0.0708	0.0650	1.65	-	44	-	12.5	4
27207100	03079	-	-	-	0.0710	0.0650	-	1-3/4	-	1/2	-	4
27207150	03080	-	-	-	0.0715	0.0650	-	1-3/4	-	1/2	-	4
27207200	03081	-	-	-	0.0720	0.0650	-	1-3/4	-	1/2	-	4
27207250	03082	-	-	-	0.0725	0.0650	-	1-3/4	-	1/2	-	4
27207280	01261	-	-	1.85	0.0728	0.0650	1.65	-	44	-	12.5	4
27207300	01265	-	49	-	0.0730	0.0650	-	1-3/4	-	1/2	-	4
27207350	03083	-	-	-	0.0735	0.0650	-	1-3/4	-	1/2	-	4
27207400	03084	-	-	-	0.0740	0.0650	-	1-3/4	-	1/2	-	4
27207450	03085	-	-	-	0.0745	0.0730	-	1-3/4	-	1/2	-	4
27207480	01269	-	-	1.90	0.0748	0.0730	1.85	-	44	-	12.5	4
27207500	03086	-	-	-	0.0750	0.0730	-	1-3/4	-	1/2	-	4
27207550	03087	-	-	-	0.0755	0.0730	-	1-3/4	-	1/2	-	4
27207600	01273	-	48	-	0.0760	0.0730	-	1-3/4	-	1/2	-	4
27207650	03088	-	-	-	0.0765	0.0730	-	1-3/4	-	1/2	-	4
27207670	01277	-	-	1.95	0.0767	0.0730	1.85	-	44	-	12.5	4
27207700	03089	-	-	-	0.0770	0.0730	-	1-3/4	-	1/2	-	4
27207750	03090	-	-	-	0.0775	0.0730	-	1-3/4	-	1/2	-	4
27207800	03091	-	-	-	0.0780	0.0730	-	1-3/4	-	1/2	-	4





Series 272 Continued

Tool No.	EDP	Diameter				Shank		OAL		Flute Length		Flutes
		D1				D2		L1		L2		
		Inch	Wire	mm	Decimal	Inch	mm	Inch	mm	Inch	mm	
27207810	01281	5/64	-	-	0.0781	0.0730	-	1-3/4	-	1/2	-	4
27207850	01285	-	47	-	0.0785	0.0730	-	1-3/4	-	1/2	-	4
27207870	01289	-	-	2.00	0.0787	0.0730	1.85	-	44	-	12.5	4
27207900	03092	-	-	-	0.0790	0.0730	-	1-3/4	-	1/2	-	4
27207950	03093	-	-	-	0.0795	0.0730	-	1-3/4	-	1/2	-	4
27208000	03094	-	-	-	0.0800	0.0730	-	1-3/4	-	1/2	-	4
27208050	03095	-	-	-	0.0805	0.0730	-	1-3/4	-	1/2	-	4
27208070	01293	-	-	2.05	0.0807	0.0730	1.85	-	44	-	12.5	4
27208100	01297	-	46	-	0.0810	0.0730	-	1-3/4	-	1/2	-	4
27208150	03096	-	-	-	0.0815	0.0800	-	2	-	1/2	-	4
27208200	01301	-	45	-	0.0820	0.0800	-	2	-	1/2	-	4
27208250	03097	-	-	-	0.0825	0.0800	-	2	-	1/2	-	4
27208270	01305	-	-	2.10	0.0827	0.0800	2.03	-	51	-	12.5	4
27208300	03098	-	-	-	0.0830	0.0800	-	2	-	1/2	-	4
27208350	03099	-	-	-	0.0835	0.0800	-	2	-	1/2	-	4
27208400	03100	-	-	-	0.0840	0.0800	-	2	-	1/2	-	4
27208450	03101	-	-	-	0.0845	0.0800	-	2	-	1/2	-	4
27208460	01309	-	-	2.15	0.0846	0.0800	2.03	-	51	-	12.5	4
27208500	03102	-	-	-	0.0850	0.0800	-	2	-	1/2	-	4
27208550	03103	-	-	-	0.0855	0.0800	-	2	-	1/2	-	4
27208600	01313	-	44	-	0.0860	0.0800	-	2	-	1/2	-	4
27208650	03104	-	-	-	0.0865	0.0800	-	2	-	1/2	-	4
27208660	01317	-	-	2.20	0.0866	0.0800	2.03	-	51	-	12.5	4
27208700	03105	-	-	-	0.0870	0.0800	-	2	-	1/2	-	4
27208750	03106	-	-	-	0.0875	0.0800	-	2	-	1/2	-	4
27208800	03107	-	-	-	0.0880	0.0800	-	2	-	1/2	-	4
27208850	03108	-	-	-	0.0885	0.0800	-	2	-	1/2	-	4
27208860	01321	-	-	2.25	0.0886	0.0800	2.03	-	51	-	12.5	4
27208900	01325	-	43	-	0.0890	0.0800	-	2	-	1/2	-	4
27208950	03109	-	-	-	0.0895	0.0880	-	2	-	1/2	-	4
27209000	03110	-	-	-	0.0900	0.0880	-	2	-	1/2	-	4
27209050	03111	-	-	-	0.0905	0.0880	-	2	-	1/2	-	4
27209060	01329	-	-	2.30	0.0906	0.0880	2.24	-	51	-	12.5	4
27209100	03112	-	-	-	0.0910	0.0880	-	2	-	1/2	-	4
27209150	03113	-	-	-	0.0915	0.0880	-	2	-	1/2	-	4
27209200	03114	-	-	-	0.0920	0.0880	-	2	-	1/2	-	4
27209250	01333	-	-	2.35	0.0925	0.0880	2.24	-	51	-	12.5	4
27209251	03626	-	-	-	0.0925	0.0880	-	2	-	1/2	-	4
27209300	03115	-	-	-	0.0930	0.0880	-	2	-	1/2	-	4
27209350	01337	-	42	-	0.0935	0.0880	-	2	-	1/2	-	4
27209370	01341	3/32	-	-	0.0937	0.0880	-	2	-	1/2	-	4
27209400	03116	-	-	-	0.0940	0.0880	-	2	-	1/2	-	4

Series 272

TrueSize®

MICRO Reamers

4 Flute



Page 152



Series 272 Continued

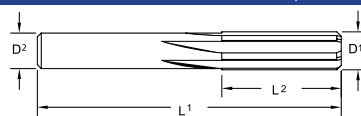

Tool No.	EDP	Diameter				Shank		OAL		Flute Length		Flutes
		D1				D2		L1		L2		
		Inch	Wire	mm	Decimal	Inch	mm	Inch	mm	Inch	mm	
27209450	01345	-	-	2.40	0.0945	0.0880	2.24	-	51	-	12.5	4
27209451	03627	-	-	-	0.0945	0.0880	-	2	-	1/2	-	4
27209500	03117	-	-	-	0.0950	0.0880	-	2	-	1/2	-	4
27209550	03118	-	-	-	0.0955	0.0880	-	2	-	1/2	-	4
27209600	01349	-	41	-	0.0960	0.0880	-	2	-	1/2	-	4
27209650	01353	-	-	2.45	0.0965	0.0880	2.24	-	51	-	12.5	4
27209651	03628	-	-	-	0.0965	0.0880	-	2	-	1/2	-	4
27209700	03119	-	-	-	0.0970	0.0880	-	2	-	1/2	-	4
27209750	03120	-	-	-	0.0975	0.0960	-	2-1/4	-	5/8	-	4
27209800	01357	-	40	-	0.0980	0.0960	-	2-1/4	-	5/8	-	4
27209840	01361	-	-	2.50	0.0984	0.0960	2.44	-	57	-	16.0	4
27209850	03121	-	-	-	0.0985	0.0960	-	2-1/4	-	5/8	-	4
27209900	03122	-	-	-	0.0990	0.0960	-	2-1/4	-	5/8	-	4
27209950	01365	-	39	-	0.0995	0.0960	-	2-1/4	-	5/8	-	4
27210000	03123	-	-	-	0.1000	0.0960	-	2-1/4	-	5/8	-	4
27210040	01366	-	-	2.55	0.1004	0.0960	2.44	-	57	-	16.0	4
27210050	03124	-	-	-	0.1005	0.0960	-	2-1/4	-	5/8	-	4
27210100	03125	-	-	-	0.1010	0.0960	-	2-1/4	-	5/8	-	4
27210150	01369	-	38	-	0.1015	0.0960	-	2-1/4	-	5/8	-	4
27210200	03126	-	-	-	0.1020	0.0960	-	2-1/4	-	5/8	-	4
27210240	01373	-	-	2.60	0.1024	0.0960	2.44	-	57	-	16.0	4
27210250	03127	-	-	-	0.1025	0.0960	-	2-1/4	-	5/8	-	4
27210300	03128	-	-	-	0.1030	0.0960	-	2-1/4	-	5/8	-	4
27210350	03129	-	-	-	0.1035	0.0960	-	2-1/4	-	5/8	-	4
27210400	01377	-	37	-	0.1040	0.0960	-	2-1/4	-	5/8	-	4
27210430	01378	-	-	2.65	0.1043	0.0960	2.44	-	57	-	16.0	4
27210450	03130	-	-	-	0.1045	0.0960	-	2-1/4	-	5/8	-	4
27210500	03131	-	-	-	0.1050	0.0960	-	2-1/4	-	5/8	-	4
27210550	03132	-	-	-	0.1055	0.1040	-	2-1/4	-	5/8	-	4
27210600	03133	-	-	-	0.1060	0.1040	-	2-1/4	-	5/8	-	4
27210630	01381	-	-	2.70	0.1063	0.1040	2.64	-	57	-	16.0	4
27210650	01385	-	36	-	0.1065	0.1040	-	2-1/4	-	5/8	-	4
27210700	03134	-	-	-	0.1070	0.1040	-	2-1/4	-	5/8	-	4
27210750	03135	-	-	-	0.1075	0.1040	-	2-1/4	-	5/8	-	4
27210800	03136	-	-	-	0.1080	0.1040	-	2-1/4	-	5/8	-	4
27210830	01389	-	-	2.75	0.1083	0.1040	2.64	-	57	-	16.0	4
27210850	03137	-	-	-	0.1085	0.1040	-	2-1/4	-	5/8	-	4
27210900	03138	-	-	-	0.1090	0.1040	-	2-1/4	-	5/8	-	4
27210940	01393	7/64	-	-	0.1094	0.1040	-	2-1/4	-	5/8	-	4
27210950	03139	-	-	-	0.1095	0.1040	-	2-1/4	-	5/8	-	4
27211000	01397	-	35	-	0.1100	0.1040	-	2-1/4	-	5/8	-	4
27211020	01401	-	-	2.80	0.1102	0.1040	2.64	-	57	-	16.0	4



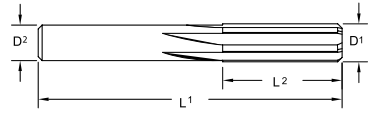

Series 272 Continued

Tool No.	EDP	Diameter				Shank		OAL		Flute Length		Flutes
		D1				D2		L1		L2		
		Inch	Wire	mm	Decimal	Inch	mm	Inch	mm	Inch	mm	
27211050	03140	-	-	-	0.1105	0.1040	-	2-1/4	-	5/8	-	4
27211100	01405	-	34	-	0.1110	0.1040	-	2-1/4	-	5/8	-	4
27211150	03141	-	-	-	0.1115	0.1040	-	2-1/4	-	5/8	-	4
27211200	03142	-	-	-	0.1120	0.1040	-	2-1/4	-	5/8	-	4
27211220	01406	-	-	2.85	0.1122	0.1040	2.64	-	57	-	16.0	4
27211250	03143	-	-	-	0.1125	0.1040	-	2-1/4	-	5/8	-	4
27211300	01409	-	33	-	0.1130	0.1040	-	2-1/4	-	5/8	-	4
27211350	03144	-	-	-	0.1135	0.1120	-	2-1/4	-	5/8	-	4
27211400	03145	-	-	-	0.1140	0.1120	-	2-1/4	-	5/8	-	4
27211420	01413	-	-	2.90	0.1142	0.1120	2.84	-	57	-	16.0	4
27211450	03146	-	-	-	0.1145	0.1120	-	2-1/4	-	5/8	-	4
27211500	03147	-	-	-	0.1150	0.1120	-	2-1/4	-	5/8	-	4
27211550	03148	-	-	-	0.1155	0.1120	-	2-1/4	-	5/8	-	4
27211600	01417	-	32	-	0.1160	0.1120	-	2-1/4	-	5/8	-	4
27211610	01418	-	-	2.95	0.1161	0.1120	2.84	-	57	-	16.0	4
27211650	03149	-	-	-	0.1165	0.1120	-	2-1/4	-	5/8	-	4
27211700	03150	-	-	-	0.1170	0.1120	-	2-1/4	-	5/8	-	4
27211750	03151	-	-	-	0.1175	0.1120	-	2-1/4	-	5/8	-	4
27211800	03152	-	-	-	0.1180	0.1120	-	2-1/4	-	5/8	-	4
27211810	01421	-	-	3.00	0.1181	0.1120	2.84	-	57	-	16.0	4
27211850	03153	-	-	-	0.1185	0.1120	-	2-1/4	-	5/8	-	4
27211900	03154	-	-	-	0.1190	0.1120	-	2-1/4	-	5/8	-	4
27211950	03155	-	-	-	0.1195	0.1120	-	2-1/4	-	5/8	-	4
27212000	01425	-	31	-	0.1200	0.1120	-	2-1/4	-	5/8	-	4
27212010	01426	-	-	3.05	0.1201	0.1120	2.84	-	57	-	16.0	4
27212050	03156	-	-	-	0.1205	0.1120	-	2-1/4	-	5/8	-	4
27212100	03157	-	-	-	0.1210	0.1120	-	2-1/4	-	5/8	-	4
27212150	03158	-	-	-	0.1215	0.1200	-	2-1/4	-	5/8	-	4
27212200	01429	-	-	3.10	0.1220	0.1200	3.05	-	57	-	16.0	4
27212201	03629	-	-	-	0.1220	0.1200	-	2-1/4	-	5/8	-	4
27212250	03159	-	-	-	0.1225	0.1200	-	2-1/4	-	5/8	-	4
27212300	03160	-	-	-	0.1230	0.1200	-	2-1/4	-	5/8	-	4
27212350	03161	-	-	-	0.1235	0.1200	-	2-1/4	-	5/8	-	4
27212400	03162	-	-	-	0.1240	0.1200	-	2-1/4	-	5/8	-	4
27212401	01436	-	-	3.15	0.1240	0.1200	3.05	-	57	-	16.0	4
27212450	03163	1/8 DP2	-	-	0.1245	0.1200	-	2-1/4	-	5/8	-	4
27212470	01434	-	-	-	0.1247	0.1200	-	2-1/4	-	5/8	-	4
27212480	03164	1/8 DP1	-	-	0.1248	0.1200	-	2-1/4	-	5/8	-	4
27212490	03165	1/8 US	-	-	0.1249	0.1200	-	2-1/4	-	5/8	-	4
27212500	01433	1/8	-	-	0.1250	0.1200	-	2-1/4	-	5/8	-	4

See full line catalog or visit www.maford.com for complete offering.





Troubleshooting Chart

Problem	Possible Solution																		
	Speed & Feed						Tool Geometry						Coolant & Stock Removal						
	Reduce Feed	Increase Feed	Reduce Speed	Increase Speed	Use Larger Reamer	Use Smaller Reamer	Bad Speed & Feed	Worn Tool Margin	Worn Cutting Edge	Uneven Lip Height	Chip Capacity of Reamer	Too Much Clearance	Grind Larger Back Taper	Bent Reamer	Insufficient Stock	Too Much Stock	Use Coolant	Run Dry	Poor Hole Prep
Burnishing		X								X					X				
Reamer Wear	X		X				X									X	X		X
Hole Quality	X		X				X	X	X						X	X	X		X
Hole Undersize	X		X		X			X	X						X	X	X		
Hole Oversize		X		X		X		X	X					X		X	X	X	X
Accuracy	X					X				X							X		
Chatter		X	X						X	X	X				X		X		
Out of Round Hole					X			X	X	X	X				X	X	X		
Hole Taper						X		X	X	X			X			X	X		
Bell Mouth		X					X	X	X		X		X	X			X		
Reamer Life		X	X				X			X		X					X		
Scoring in Bore							X	X	X	X					X	X	X		X
Deflection																			

Problem	Possible Solution													
	Set Up							Cutting Errors						
	Alignment	Holder Accuracy	Concentricity	Use Adjustable Holder	Use Floating Holder	Lack of Rigidity in Set-Up	Work Holding Error	Spindle Bearings	Tool Extended Too Far	Poor Re grind	Poor Machinability	Built Up Edge	Wrong Tool	Poor Chip Removal
Burnishing	X						X			X				
Reamer Wear	X	X					X			X	X		X	
Hole Quality	X		X				X			X	X	X	X	
Hole Undersize	X										X			
Hole Oversize	X		X				X			X	X	X	X	
Accuracy							X			X				
Chatter	X	X				X	X	X	X	X				
Out of Round Hole	X						X			X				
Hole Taper	X	X	X	X	X		X			X	X	X		
Bell Mouth	X	X	X	X	X		X			X	X			
Reamer Life	X	X	X			X	X	X	X	X				
Scoring in Bore			X								X	X		X
Deflection	X													

Technical data provided should be considered advisory only as variations may be necessary depending on the particular application.



Total Stock Allowance - Inch

Material		Drill Decimal Equivalent/Size			
		.0135	.029/.028	.055/.052	.113
		#80	#69/#70	#54/#55	#33
		Reamer Diameter			
		.0150	.0320	.0625	.1250
		Total Stock Allowance			
Magnesium		.0014	.0030	.0060	.0110
Aluminum	<5%SI	.0014	.0030	.0060	.0110
	>5%SI	.0014	.0030	.0060	.0110
Brass & Soft Bronze	Brass	.0014	.0030	.0060	.0110
	Bronze	.0014	.0030	.0060	.0110
Copper & Hard Bronze		.0014	.0030	.0060	.0110
Cast Iron	Cast	.0013	.0028	.0055	.0099
	Ductile	.0013	.0028	.0055	.0099
Steel	<35% C	.0013	.0028	.0055	.0099
	>35% C	.0012	.0025	.0049	.0089
	Tool	.0012	.0025	.0049	.0089
	Hard	.0009	.0020	.0040	.0072
Stainless		.0012	.0025	.0049	.0089
High Temp Alloys	Soft	.0012	.0025	.0049	.0089
	Hard	.0010	.0023	.0044	.0081
Titanium		.0013	.0028	.0055	.0099

Dowel Pin Chart - Inch

Dowel Pin	Nominal Dowel Decimal	Tight Press Fit Reamer		Tight Press Fit Reamer 0.0005		Loose Press Fit Reamer		Tight Slip Fit		Loose Slip Fit Reamer	
Size	Decimal	0.0005	Tool No.	DP(2)	Tool No.	DP(1)	Tool No.	Reamer	Tool No.	OS	Tool No.
1/8	.1250	.1230	27212300	.1245	27212450	.1248	27212480	.1255	27212550	.1260	27212601

+ 0.0001/ +0.0003 Tolerance (Reamer) Normal Dowels are nominal Size +.0001/ -.0001

Safety Note

Always wear the appropriate personal protective equipment such as safety glasses and protective clothing when using solid carbide or HSS cutting tools. Machines should be fully guarded. Technical data provided should be considered advisory only as variations may be necessary depending on the particular application.

Technical data provided should be considered advisory only as variations may be necessary depending on the particular application.



Total Stock Allowance - Metric

Material		Drill Size mm			
		0.30	0.90	1.80	2.70
		Reamer Diameter			
		0.35	1.00	2.00	3.00
		Total Stock Allowance			
Magnesium		.04	.09	.19	.27
Aluminum	<5%SI	.04	.09	.19	.27
	>5%SI	.04	.09	.19	.27
Brass & Soft Bronze	Brass	.04	.09	.19	.27
	Bronze	.04	.09	.19	.27
Copper & Hard Bronze		.04	.09	.19	.27
Cast Iron	Cast	.03	.09	.17	.24
	Ductile	.03	.09	.17	.24
Steel	<35% C	.03	.09	.17	.24
	>35% C	.03	.08	.15	.21
	Tool	.03	.08	.15	.21
	Hard	.02	.06	.12	.17
Stainless		.03	.08	.15	.21
High Temp Alloys	Soft	.03	.08	.15	.21
	Hard	.03	.07	.14	.20
Titanium		.03	.09	.17	.24

Technical Information
MICRO Reamers

Dowel Pin Chart - Inch

Dowel Pin	Nominal Dowel Decimal	Tight Press Fit Reamer		Tight Press Fit Reamer 0.013		Loose Press Fit Reamer		Tight Slip Fit		Loose Slip Fit Reamer	
Size (mm)	Decimal	0.013	Tool No.	DP(2)	Tool No.	DP(1)	Tool No.	Reamer	Tool No.	OS	Tool No.
2	0.0787	1.95	27207670	1.98	27207810	1.99	27207850	2.01	27207900	2.02	27207950
3	0.1181	2.95	27211610	2.98	27211750	3.00	27211800	3.01	27211850	3.02	27211900

Tolerance (Reamer) Per DIN 1420 H7 Normal Dowels are nominal size +.0001" / -.0001" (+.0025/-.0025mm)

Technical data provided should be considered advisory only as variations may be necessary depending on the particular application.



Reamer Cutting Data - Inch

Workpiece Material Group	I S O	Hardness	vc-SFM	Reamer Diameter	
				f-IPR	
				≥ 1/16	>1/16 - 1/8
Free Machining & Low Carbon Steels 1006, 1008, 1015, 1018, 1020, 1022, 1025, 1117, 1140, 1141, 11L08, 11L14, 1213, 12L13, 12L14, 1215, 1330	P	up to 28 Rc	200-300	.0005-.0030	.0020-.0060
Medium Carbon & High Carbon Steels, Alloy Steels & Easy to Machine Tool Steels 1030, 1035, 1040, 1045, 1050, 1052, 1055, 1060, 1085, 1095, 1541, 1551, 9255, 2515, 3135, 3415, 4130, 4137, 4140, 4150, 4320, 4340, 4520, 5015, 5115, 5120, 5132, 5140, 5155, 6150, 8620, 9262, 9840, 52100, O1, O2, O6, S2, W1 to W310	P	28 to 38 Rc	125-200	.0005-.0020	.0020-.0040
Tool Steels & Die Steels O7, M1, M2, M3, M4, M7, T1, T2, T4, T5, T8, T15, A2, A3, A6, A7, H10, H11, H12, H13, H19, H21, L3, L6, L7, P2, P20, S1, S5, S7, 52100, A 128, D2, D3, D4, D5, D7	P	28 to 44 Rc	50-125	.0002-.0010	.0010-.0020
Stainless Steel - Free Machining / Austenitic 304/316	M	up to 28 Rc	120-190	.0005-.0020	.0020-.0040
Stainless Steel - Ferritic / Martensitic	M	up to 28 Rc	80-120		
Stainless Steel - Moderately Difficult 301, 302, 303 High Tensile, 304, 304L, 305, 420, 15-5PH, 17-4PH, 17-7PH	M	up to 28 Rc	60-100	.0002-.0020	.0010-.0040
Inconel 625/718	S	≤ 40 Rc	40-70	.0002-.0010	.0010-.0020
Stellite / Cobalt Chrome	S	≤ 40 Rc	30-45		
Titanium 6Al-4V	S	≤ 40 Rc	35-50	.0002-.0020	.0010-.0040
Cast Iron - Gray CGI, ASTM A48, CLASS 20, 25, 30, 35, SAE J431C, GRADES G1800, G3000, G3500, GG 10, 15, 20, 25, 30, 35, 40	K	up to 240 HB	150-250	.0002-.0020	.0010-.0040
Cast Iron - Ductile & Malleable CGI 60-40-18, 65-45-12, D4018, D4512, D5506, 32510, 35108, M3210, M4504, M5503, 250, 300, 350, 400, 450	K	over 240 HB	125-200	.0005-.0020	.0020-.0040
Cast Iron - (Martensitic) Hard	K		50-75	.0002-.0010	.0010-.0020
Aluminum/Aluminum Alloys	N		500-1000	.0005-.0030	.0020-.0060
Brass/Bronze Free Machining	N		250-400	.0005-.0020	.0020-.0040
Brass/Bronze (Hard)	N		150-250		
Magnesium/Magnesium Alloys/Plastics/Bakelite Plastic - Glass Filled	N		500-1000	.0005-.0030	.0020-.0060
Copper/Hard Bronze	N		100-150	.0002-.0010	.0010-.0020
Hardened Steels	H	23-32 Rc	125-200	.0005-.0020	.0020-.0040
Hardened Steels	H	32-43 Rc	50-125	.0002-.0010	.0010-.0020
Hardened Steels	H	43-52 Rc	35-50		
Hardened Steels	H	50+ Rc	15-35	.0002-.0010	.0010-.0020

Technical data provided should be considered advisory only as variations may be necessary depending on the particular application.



Reamer Cutting Data - Metric

Workpiece Material Group	I S O	Hardness	vc-m/min	Reamer Diameter (mm)	
				f-mm/rev	
				≥ 1.5	>1.5 - 3.0
Free Machining & Low Carbon Steels 1006, 1008, 1015, 1018, 1020, 1022, 1025, 1117, 1140, 1141, 11L08, 11L14, 1213, 12L13, 12L14, 1215, 1330	P	up to 28 Rc	60-90	.010-.080	.050-.150
Medium Carbon & High Carbon Steels, Alloy Steels & Easy to Machine Tool Steels 1030, 1035, 1040, 1045, 1050, 1052, 1055, 1060, 1085, 1095, 1541, 1551, 9255, 2515, 3135, 3415, 4130, 4137, 4140, 4150, 4320, 4340, 4520, 5015, 5115, 5120, 5132, 5140, 5155, 6150, 8620, 9262, 9840, 52100, O1, O2, O6, S2, W1 to W310	P	28 to 38 Rc	40-60	.010-.050	.050-.100
Tool Steels & Die Steels O7, M1, M2, M3, M4, M7, T1, T2, T4, T5, T8, T15, A2, A3, A6, A7, H10, H11, H12, H13, H19, H21, L3, L6, L7, P2, P20, S1, S5, S7, 52100, A 128, D2, D3, D4, D5, D7	P	28 to 44 Rc	15-40	.010-.030	.030-.050
Stainless Steel - Free Machining / Austenitic 304/316	M	up to 28 Rc	35-60	.010-.050	.050-.100
Stainless Steel - Ferritic / Martensitic	M	up to 28 Rc	25-35		
Stainless Steel - Moderately Difficult 301, 302, 303 High Tensile, 304, 304L, 305, 420, 15-5PH, 17-4PH, 17-7PH	M	up to 28 Rc	20-30	.010-.050	.030-.100
Inconel 625/718	S	≤ 40 Rc	15-20	.010-.030	.030-.050
Stellite / Cobalt Chrome	S	≤ 40 Rc	10-15		
Titanium 6Al-4V	S	≤ 40 Rc	10-15		
Cast Iron - Gray CG, ASTM A48, CLASS 20, 25, 30, 35, SAE J431C, GRADES G1800, G3000, G3500, GG 10, 15, 20, 25, 30, 35, 40	K	up to 240 HB	45-75	.010-.050	.030-.100
Cast Iron - Ductile & Malleable CGI 60-40-18, 65-45-12, D4018, D4512, D5506, 32510, 35108, M3210, M4504, M5503, 250, 300, 350, 400, 450	K	over 240 HB	40-60	.010-.050	.050-.100
Cast Iron - (Martensitic) Hard	K		15-25	.010-.030	.030-.050
Aluminum/Aluminum Alloys	N		150-300	.010-.080	.050-.150
Brass/Bronze Free Machining	N		75-120	.010-.050	.050-.100
Brass/Bronze (Hard)	N		45-75		
Magnesium/Magnesium Alloys/Plastics/Bakelite Plastic - Glass Filled	N		150-300	.010-.080	.050-.150
Copper/Hard Bronze	N		30-45	.010-.030	.030-.050
Hardened Steels	H		23-32 Rc	40-60	.010-.050
Hardened Steels	H	32-43 Rc	15-40	.010-.030	.030-.050
Hardened Steels	H	43-52 Rc	10-15		
Hardened Steels	H	50+ Rc	5-10		

Technical data provided should be considered advisory only as variations may be necessary depending on the particular application.

TrueSize® Reamers

Features

- Solid carbide, straight flute RHC, 45° lead angle.
- Metric sizes manufactured to DIN 1420 H7.
- LHS series 270L

Benefits

- High precision hole finishes.
- Wide range of material applications.
- Over 900 stocked standard sizes from .0130" - 5/8" and 0.35mm - 16mm.

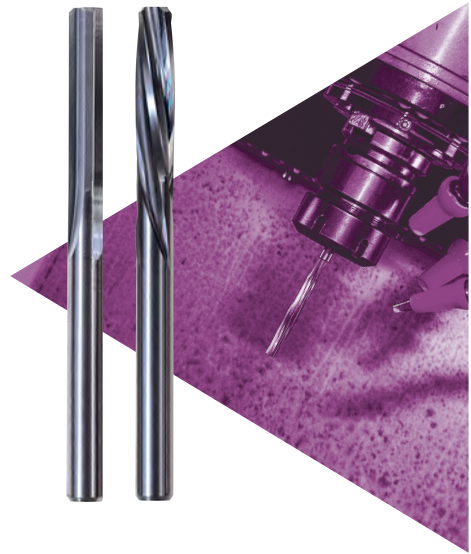

Countersinks

Features

- 0 flute, single flute, 3 flute, 6 flute versions.
- Carbide and HSS material.
- Micro-stop style.
- ALtima® Blaze and TiN coated options.
- Available with 60°, 82°, 90°, 100° and 120° included angles.

Benefits

- For general purpose countersinking, chamfering or deburring.
- Self piloting and completely chatterless.
- No secondary burs formed.
- Each size maybe used on a wide range of hole diameters.
- Wide range of material applications.
- Easily resharpened.
- Size range 1/8" - 3".



See full line catalog or visit www.maford.com for complete offering.

Countersinks

The Original Countersink
from M.A. Ford®

For Machine or Hand Countersinking

M.A. Ford® provides one of the most complete lines of high-speed steel and carbide countersinks. Tools are available in a variety of flute designs for countersinking virtually any material by machine or by hand.

Heat Treated Countersinks Deliver Increased Productivity and Tool Life

All M.A. Ford® HSS countersinks are heat treated in an electronically controlled vacuum furnace. This assures precise hardening and eliminates the possibility of decarburization. All heat treating is done in our own facilities for maximum control and assurance of desired hardness and toughness.

Most M.A. Ford® HSS countersinks receive an additional heat treat process known as the Steam Homogeneous Process. This process is like a final tempering, relieving internal grinding stresses. The result is a much tougher cutting edge that stays sharper, longer. Additionally, the Steam Homogeneous Process provides a tough, hard, porous oxide film on the tool that is sufficient enough to retain cutting oil, further reducing frictional heat and extending tool life.

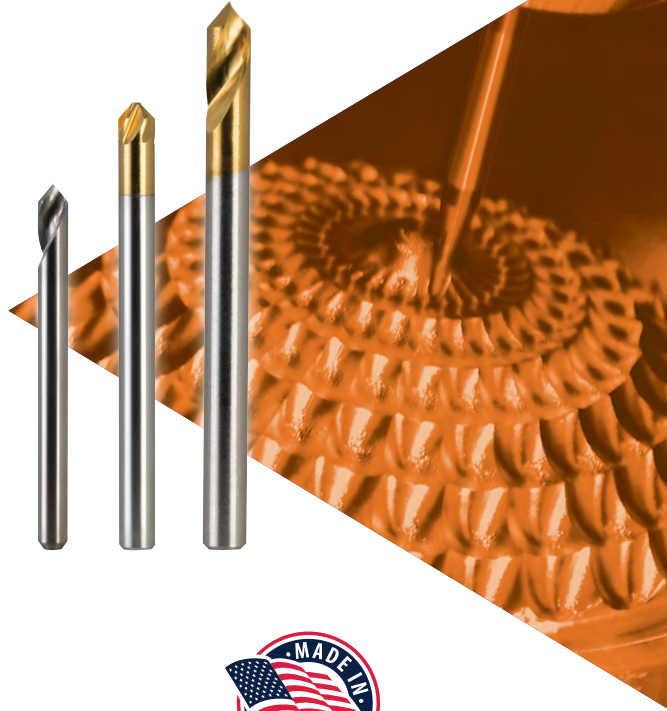

ALtima® Blaze

Features high temperature hardness and oxidation resistance that provides extreme wear resistance under all machining conditions.



TiN coating

Provides a higher surface hardness and increased lubricity over an uncoated tool.

Coating Properties

	TiN	ALtima® Blaze
Micro Hardness (HV)	2300	3200
Max. Working Temperature	600° C 1112° F	1100° C 2012° F
Friction Coefficient	0.40	0.35

	Page
Carbide Uniflute® Countersinks Series 60	156
HSS Uniflute® Countersinks Series 61	156
HSS Uniflute® Countersinks Series 61B	156
HSS Uniflute® Countersinks Series 61T	156
Carbide Chatterless Six Flute Countersinks Series 78	157

	Page
HSS Chatterless Six Flute Countersinks Series 79	157
HSS Chatterless Six Flute Countersinks Series 79B	157
HSS Chatterless Six Flute Countersinks Series 79T	157
Technical Information	158-159

Series 60

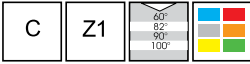

- Recommended for use on abrasive, non-metallic and non-ferrous materials.
- Easily resharpened.
- Can be used on hardened steel and work hardening alloys.
- Rigid set-ups and good machinery maintenance are a must.
- Not recommended for use in handheld tools.

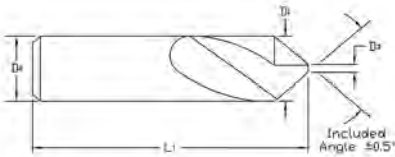

Series 61/61B/61T

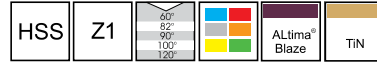

- Self piloting and completely chatterless.
- No secondary burrs formed.
- Each size used on a wide range of hole diameters.
- Use on machine tool or in handheld tool applications.
- Easily resharpened.
- Steam homogeneous surface treatment (blackening) to prolong tool life and prevent galling.
- ALtima® Blaze for extreme wear resistance under all machining conditions.
- TiN coating for higher surface hardness and increased lubricity.

Tool No.	EDP	Diameter		OAL	Included Angle*	Coating	Non-Cutting OD Max	Material
		D1	D2				D3	
60012501	60001	1/8	1/8	1-1/2	60°	Uncoated	.015	Carbide
60012502	60006	1/8	1/8	1-1/2	82°	Uncoated	.030	Carbide
60012503	60011	1/8	1/8	1-1/2	90°	Uncoated	.030	Carbide
60012504	60016	1/8	1/8	1-1/2	100°	Uncoated	.030	Carbide
61012501	61001	1/8	1/8	1-1/2	60°	Blackening	.030	HSS
61012502	61006	1/8	1/8	1-1/2	82°	Blackening	.030	HSS
61012503	61011	1/8	1/8	1-1/2	90°	Blackening	.030	HSS
61012504	61016	1/8	1/8	1-1/2	100°	Blackening	.030	HSS
61012506	61021	1/8	1/8	1-1/2	120°	Blackening	.030	HSS
61B012501	61003	1/8	1/8	1-1/2	60°	ALtima® Blaze	.030	HSS
61B012502	61008	1/8	1/8	1-1/2	82°	ALtima® Blaze	.030	HSS
61B012503	61013	1/8	1/8	1-1/2	90°	ALtima® Blaze	.030	HSS
61B012504	61018	1/8	1/8	1-1/2	100°	ALtima® Blaze	.030	HSS
61B012506	61023	1/8	1/8	1-1/2	120°	ALtima® Blaze	.030	HSS
61T012501	61002	1/8	1/8	1-1/2	60°	TiN	.030	HSS
61T012502	61007	1/8	1/8	1-1/2	82°	TiN	.030	HSS
61T012503	61012	1/8	1/8	1-1/2	90°	TiN	.030	HSS
61T012504	61017	1/8	1/8	1-1/2	100°	TiN	.030	HSS
61T012506	61022	1/8	1/8	1-1/2	120°	TiN	.030	HSS

*Standard angles may be modified, contact customer service for details

Coating Properties		
	TiN	ALtima® Blaze
Micro Hardness (HV)	2300	3200
Max. Working Temperature	600° C 1112° F	1100° C 2012° F
Friction Coefficient	0.40	0.35



See full line catalog or visit www.maford.com for complete offering.

Chatterless Six Flute Countersinks



Series 78

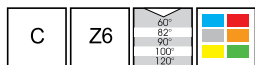

Solid carbide construction (steel shanks on tools 3/8" diameter and larger) makes this countersink ideal for hardened steel, high temperature alloys and other tough jobs.

- Rigid set-ups and good machine tool maintenance are a must.
- Not recommended for handheld applications.



Series 79/79B/79T

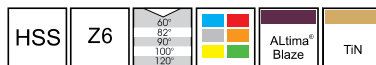

Standard six flute countersinks are designed for economical general purpose countersinking, chamfering or deburring. Because of the multiple flute design, chip loads are generally smaller. Even at maximum speeds, chatter-free machining is possible.

- Steam homogeneous surface treatment (blackening) is used to prolong tool life and prevent galling.
- ALtima® Blaze for extreme wear resistance under all machining conditions.
- TiN coating for higher surface hardness and increased lubricity.

Tool No.	EDP	Diameter		OAL	Included Angle	Coating	Non-Cutting OD Max		Material
		D1	D2				D3		
78012501	78001	1/8	1/8	1-1/2	60°	Uncoated	.030		Carbide
78012502	78006	1/8	1/8	1-1/2	82°	Uncoated	.030		Carbide
78012503	78011	1/8	1/8	1-1/2	90°	Uncoated	.030		Carbide
78012504	78016	1/8	1/8	1-1/2	100°	Uncoated	.030		Carbide
78012506	78021	1/8	1/8	1-1/2	120°	Uncoated	.030		Carbide
79012501	79021	1/8	1/8	1-1/2	60°	Blackening	.030		HSS
79012502	79026	1/8	1/8	1-1/2	82°	Blackening	.030		HSS
79012503	79031	1/8	1/8	1-1/2	90°	Blackening	.030		HSS
79012504	79036	1/8	1/8	1-1/2	100°	Blackening	.030		HSS
79012506	79041	1/8	1/8	1-1/2	120°	Blackening	.030		HSS
79B012501	79023	1/8	1/8	1-1/2	60°	ALtima® Blaze	.030		HSS
79B012502	79028	1/8	1/8	1-1/2	82°	ALtima® Blaze	.030		HSS
79B012503	79033	1/8	1/8	1-1/2	90°	ALtima® Blaze	.030		HSS
79B012504	79039	1/8	1/8	1-1/2	100°	ALtima® Blaze	.030		HSS
79B012506	79043	1/8	1/8	1-1/2	120°	ALtima® Blaze	.030		HSS
79T012501	79022	1/8	1/8	1-1/2	60°	TiN	.030		HSS
79T012502	79027	1/8	1/8	1-1/2	82°	TiN	.030		HSS
79T012503	79032	1/8	1/8	1-1/2	90°	TiN	.030		HSS
79T012504	79037	1/8	1/8	1-1/2	100°	TiN	.030		HSS
79T012506	79042	1/8	1/8	1-1/2	120°	TiN	.030		HSS

See full line catalog or visit www.maford.com for complete offering.



Page 158



Application Data

Speeds Inch

To determine optimum speed, start at the lower end of the speed range, and then increase speeds until performance is maximized. When a countersink is operated at excessive RPM (n), chatter may result, and cutting edges can overheat and become prematurely dull.

Material	vc - SFM			
	HSS	HSS TiN Coated	HSS ALTIMA® Blaze Coated	Carbide
Aluminum / Aluminum Alloys	150-250	190-315	240-400	300-500
Brass / Bronze (ordinary)	75-125	90-160	120-200	150-250
Iron - Cast (soft)	75-125	90-160	120-200	125-225
Iron - Cast (medium hard)	50-100	65-125	80-160	100-175
Iron - Hard Chilled	10-20	15-25	20-35	20-35
Iron - Malleable	80-90	100-115	130-145	90-150
Magnesium / Magnesium Alloys	125-250	160-310	200-400	250-400
Monel, High Nickel Steel	30-50	40-65	50-80	50-75
Plastics, Bakelite	100-250	125-315	160-400	250-400
Steel - Mild (.2 - .3 carbon)	80-100	100-125	130-160	120-170
Steel - Mild (.4 - .5 carbon)	70-80	85-100	115-130	80-150
Tool Steels (1.2 carbon)	50-60	65-75	80-100	60-100
Steel - Forgings	40-50	50-65	65-80	50-80
Steel - Alloys (300 - 400 Brinnell)	20-30	25-40	35-50	30-50
Steel - High Tensile (35 - 40 Rc)	30-40	40-50	50-65	40-60
Steel - High Tensile (40 - 45 Rc)	25-35	30-45	40-56	35-55
Steel - High Tensile (45 - 50 Rc)	15-25	20-30	25-40	25-40
Steel - High Tensile (50 - 55 Rc)	7-15	10-20	15-30	15-20
Stainless Steel - Free Machining	30-80	40-100	50-130	80-125
Stainless Steel - Work Hardening	15-50	20-65	30-80	50-75
Ti-75A (commercially pure Titanium)	50-60	65-75	80-100	60-90
Inconel Alloys	15-20	20-25	25-35	25-35

Diameter Gain in Size For Each .001" of Axial Depth in Hole

Included Angle	Axial Depth ap (inch)	Dia. Gain
30°	.0010	.0005
45°	.0010	.0008
60°	.0010	.0010
82°	.0010	.0017
90°	.0010	.0020
100°	.0010	.0028
120°	.0010	.0034

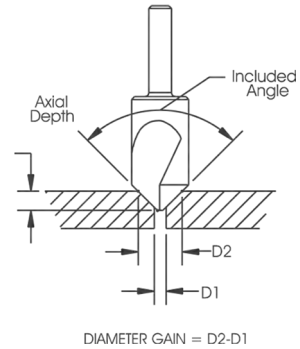

Feeds Inch

Series	Countersink Diameter	
	1/8"	
	f-IPR	
60 / 61	.001-.004	
78 / 79	.001-.004	

Always start the feed at the low end of the range, and then slowly increase until chatter is eliminated.

To prevent the cam relief from rubbing on the workpiece, do not exceed maximum feed when using the 60 / 61 Uniflute® Series Countersinks.

Technical data provided should be considered advisory only as variations may be necessary depending on the particular application.



Speeds Metric

Material	vc - m/min.			
	HSS	HSS TiN Coated	HSS ALtima® Blaze Coated	Carbide
Aluminum / Aluminum Alloys	45-75	60-100	75-120	90-155
Brass / Bronze (ordinary)	25-40	30-50	35-60	45-80
Iron - Cast (soft)	25-40	30-50	35-60	40-70
Iron - Cast (medium hard)	15-30	20-40	25-50	30-55
Iron - Hard Chilled	3-10	5-10	5-10	5-10
Iron - Malleable	25-30	30-35	40-45	30-45
Magnesium / Magnesium Alloys	40-75	50-95	60-120	75-125
Monel, High Nickel Steel	10-15	10-20	15-25	15-25
Plastics, Bakelite	30-75	40-100	50-120	80-120
Steel - Mild (.2 - .3 carbon)	25-30	30-40	40-50	40-50
Steel - Mild (.4 - .5 carbon)	20-25	25-30	35-40	25-45
Tool Steels (1.2 carbon)	15-20	20-25	25-30	20-30
Steel - Forgings	10-15	15-20	20-25	15-25
Steel - Alloys (300 - 400 Brinnell)	5-10	10-15	10-15	10-15
Steel - High Tensile (35 - 40 Rc)	10-15	10-15	15-20	15-20
Steel - High Tensile (40 - 45 Rc)	8-15	10-15	10-20	10-20
Steel - High Tensile (45 - 50 Rc)	5-10	5-10	8-10	8-15
Steel - High Tensile (50 - 55 Rc)	2-5	3-5	5-10	5-6
Stainless Steel - Free Machining	10-25	10-30	15-40	25-40
Stainless Steel - Work Hardening	5-10	5-20	10-25	15-25
Ti-75A (commercially pure Titanium)	15-20	20-25	25-30	20-30
Inconel Alloys	5-6	5-10	5-10	8-15

Conversion Formulas

$$\frac{(\text{vc-m/min} \times 318.057)}{\text{Tool Diameter}} = \text{RPM (n)}$$

$$\frac{(\text{vc-SFM} \times 3.82)}{\text{Tool Diameter}} = \text{RPM (n)}$$

*Tool Diameter must be in mm.

Feeds Metric

Series	Countersink Diameter	
	1/8"	
	f-mm/Rev	
60 / 61	.025-.100	
78 / 79	.025-.100	

Always start the feed at the low end of the range, and then slowly increase until chatter is eliminated.

To prevent the cam relief from rubbing on the workpiece, do not exceed maximum feed when using the 60 / 61 Uniflute® Series Countersinks.

Diameter Gain in Size For Each .025mm of Axial Depth in Hole

Included Angle	Axial Depth ap (mm)	Dia. Gain (mm)
30°	.025	.0127
45°	.025	.0203
60°	.025	.0254
82°	.025	.0432
90°	.025	.0508
100°	.025	.0711
120°	.025	.0864

Minimum Body Diameter For 90° Flat Head Cap Screws (mm)

Screw Size(mm)	C'sink Diameter
3	7

Safety Note

Always wear the appropriate personal protective equipment such as safety glasses and protective clothing when using solid carbide or HSS cutting tools. Machines should be fully guarded.

Technical data provided should be considered advisory only as variations may be necessary depending on the particular application.

Diamond Coated Routers

The "Black Diamond"

Series 239

Benefits

- Excellent for composite materials and fiberglass applications.
- Long Tool life.
- Cut more linear inches.
- Faster cycle times.
- High routing rate.
- Delivers great edge quality.
- No delamination or flaking.

Features

- Rake angles specially designed to reduce cutting forces.
- Cutting edges specially treated for optimized tool life.
- Carbide substrate uniquely compatible to GemX coating.
- GemX coating specifically designed for maximum tool life in composites.
- Size range 1/8" - 1/2", 3.0mm - 12.0mm.

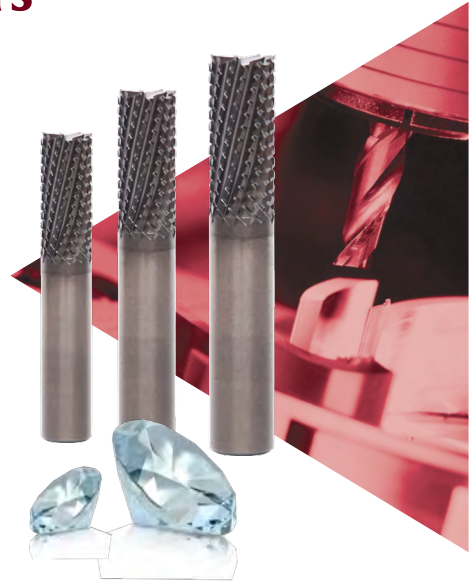

Diamond Grind Routers

Series 230, 231, 231B, 231D & 231F

Diamond Grind Routers are designed specifically for routing printed circuit boards. These tools are available with a non-cutting safe end, or in four popular end-cutting styles all with down cut geometries.

- Size range 1/32" - 3/8", 0.8mm - 8.0mm.

See full line catalog or visit www.maford.com for complete offering.

Diamond Coated Routers

The “Black Diamond”

Series 239

- GemX coating and uncoated options available.
- Up cut router.
- Excellent for composite materials and fiberglass applications.
- Licensed for Boeing U.S. Patent 7,090,442*.

M.A. Ford®’s NEW Diamond Coated Routers

Series 239 Coated with GemX Diamond Coating

M.A. Ford® Coating	M.A. Ford® Tool Number Designation	Micro-hardness (HV)	Max Service Temp.	Friction Coefficient
GemX	GX	10,000	600° C / 1100° F	0.10

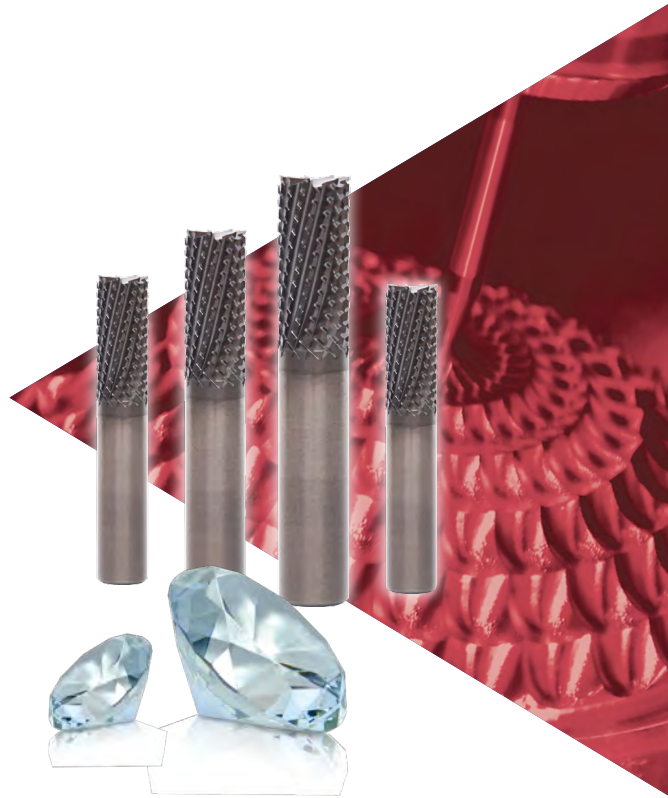

Applications

- Trimming
- Routing
- Pocketing
- Interpolation of holes
- Low plastic content CFRP

- Routers are available with a non-cutting safe end or in three popular end-cutting styles.

*M.A. Ford® has an agreement with The Boeing Company and has been granted license rights to use Boeing patents and proprietary data.



Page

Diamond Coated Routers Series 239	162
Technical Information	163

Series 239



- Upcut.
- Diamond grind GemX coated or uncoated.

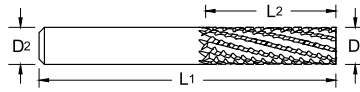

Bur End



End Mill



Safe End



Fishtail Metric
Sizes Only



Uncoated		GemX		Diameter D1		Shank D2	OAL L1	Flute Lgth L2	# Flutes (RHC)	End Cut
				Size	Decimal					
239M0300	24039	-	-	3.0	.1181	3.0	38	12.0	6	Safe
239M0300B	23945	239M0300BGX	23969	3.0	.1181	3.0	38	12.0	6	Bur
239M0300E	23946	239M0300EGX	23970	3.0	.1181	3.0	38	12.0	6	End Mill
239M0300F	23947	239M0300FGX	23971	3.0	.1181	3.0	38	12.0	6	Fishtail
23912500	23994	-	-	1/8	.1250	1/8	1-1/2	1/4	6	Safe
23912500B	23901	23912500BGX	23900	1/8	.1250	1/8	1-1/2	1/4	6	Bur
23912510	23996	-	-	1/8	.1250	1/8	1-1/2	3/8	6	Safe
23912510E	23903	23912510EGX	23902	1/8	.1250	1/8	1-1/2	3/8	6	End Mill
23912520	23997	-	-	1/8	.1250	1/8	1-1/2	1/2	8	Safe
23912520E	23905	23912520EGX	23904	1/8	.1250	1/8	1-1/2	1/2	8	End Mill

*Stock available for desired end features with a quicker turnaround than most manufacturing suppliers!



Safety Note

Always wear the appropriate personal protective equipment such as safety glasses and protective clothing when using solid carbide or HSS cutting tools. Machines should be fully guarded.

See full line catalog or visit www.maford.com for complete offering.



Recommended Cutting Data Series 239 - Inch

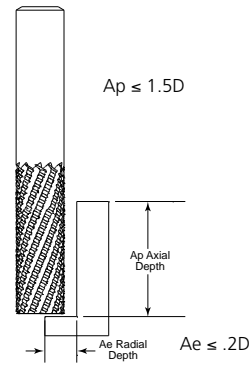
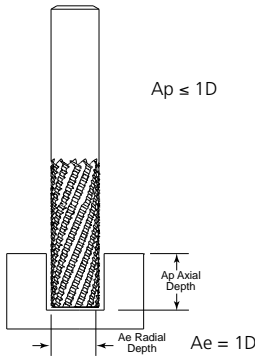

Finishing Slotting 300 (Sfm)			Roughing Slotting 600 (Sfm)		
Tool Diameter	RPM	IPM	Tool Diameter	RPM	IPM
1/8	9000	10	1/8	18000	20

Feed adjustment to part thickness	
≤ 0.5D	x 150%
0.5D - 1D	x 120%
1D - 2D	x 80%
3D-4D	x 50%

Finishing Side Milling 400 (Sfm)			Roughing Side Milling 800 (Sfm)		
Tool Diameter	RPM	IPM	Tool Diameter	RPM	IPM
1/8	12000	20	1/8	24000	40

** Tool must have end grind to slot.

Note: The parameters in this table are for common material thickness of 1/4". You must use the Radial Depth (Ae) of 20% or less for Side Milling. For best surface finish conventional mill is recommended. Higher feed rates are possible but surface finish may change.

Recommended Cutting Data Series 239 - Metric

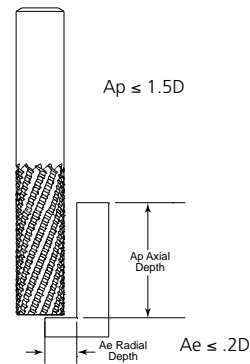
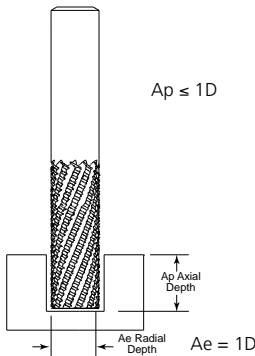

Finishing Slotting 90 (m/min)			Roughing Slotting 180 (m/min)		
Tool Diameter	RPM	mm/min	Tool Diameter	RPM	mm/min
3	9000	254	3	18000	508

Feed adjustment to part thickness	
≤ 0.5D	x 150%
0.5D - 1D	x 120%
1D - 2D	x 80%
3D-4D	x 50%

Finishing Side Milling 120 (m/min)			Roughing Side Milling 240 (m/min)		
Tool Diameter	RPM	mm/min	Tool Diameter	RPM	mm/min
3	12000	508	3	24000	1016

** Tool must have end grind to slot.

Note: The parameters in this table are for common material thickness of 6mm. You must use the Radial Depth (Ae) of 20% or less for Side Milling. For best surface finish conventional mill is recommended. Higher feed rates are possible but surface finish may change.

Technical data provided should be considered advisory only as variations may be necessary depending on the particular application.

Diamond Grind Routers

Diamond Grind Routers are designed specifically for routing printed circuit boards. These tools are available with a non-cutting safe end, or in four popular end-cutting styles all with down cut geometries.

Router Application Data

When machining circuit boards, board stack height should be limited to 2-1/2 times the router diameter. In general, as total stack height increases, cutting speed RPM (n) should be decreased.

Polyamid or Teflon circuit boards should not be stacked.

When routing outside edges, the router should be fed counterclockwise. Conversely, for inside edges, the router should be fed clockwise.

Speeds and Feeds

Diamond Grind Routers are designed to operate between 600 and 900 surface-feet-per-minute (180-275 vc-m/min) - Approximately 30,000 RPM (n) for a 3/32-inch (2.4mm) router and 23,000 RPM (n) for a 1/8-inch (3.175mm) router. Speeds must be reduced for Teflon circuit boards. See recommended cutting data charts on page 167.

Diamond Grind Routers should be fed approximately .002 inch-per-revolution (.05 mm/rev.). For a 3/32-inch (2.4mm) router, this is 60-80 IPM (1524-2032 mm/min.). A 1/8-inch (3.175mm) router should be fed approximately 40-50 IPM (1016-1270 mm/min.). See recommended cutting data charts on page 167.

If the feed rate is too low, heat will cause melting of epoxy materials, causing the router flutes to load up, reducing tool life. For multi-layer boards, feed rates should be reduced, depending on the number of inner layers. The higher the number of inner layers, the slower the feed rate must be. See recommended cutting data charts on page 167.

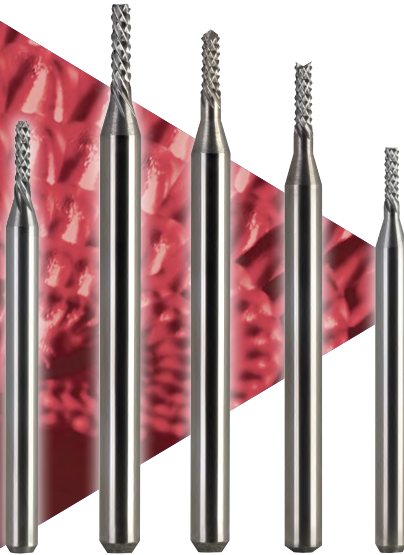

Safety Note

Always wear the appropriate personal protective equipment such as safety glasses and protective clothing when using solid carbide or HSS cutting tools. Machines should be fully guarded.

Technical data provided should be considered advisory only as variations may be necessary depending on the particular application.

	Page
Diamond Grind Routers Series 230 / 231 / 231B	165
Diamond Grind Routers Series 231D / 231F	166

	Page
Technical Information	167-168



Series 230 / 231 / 231B



- Designed for routing of glass-reinforced printed circuit boards, phenolic-epoxy and other highly abrasive materials.
- Ultra fine micrograin carbide.
- Routers are available with color coded depth setting rings upon request.



Series 230 Down Cut
Safe End



Series 231 Down Cut
End Mill



Series 231B Down Cut
Burr End

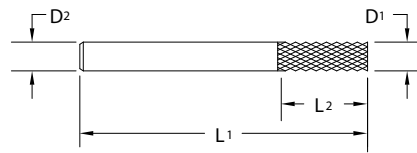

Series 230		Series 231		Series 231B		Diameter			Shank		OAL		Flute Length	
Tool No.	EDP	Tool No.	EDP	Tool No.	EDP	D1			D2		L1		L2	
						Inch	mm	Decimal	Inch	mm	Inch	mm	Inch	mm
23003120	90801	23103120	90901	23103120B	90904	1/32	-	.0312	1/8	-	1-1/2	-	1/8	-
23003150	90804	23103150	90913	23103150B	90916	-	0.8	.0315	-	3.175	-	38	-	3.0
23003940	90807	23103940	90925	23103940B	90928	-	1.0	.0394	-	3.175	-	38	-	4.0
23004690	90810	23104690	90937	23104690B	90940	3/64	-	.0469	1/8	-	1-1/2	-	5/32	-
23004720	90813	23104720	90949	23104720B	90952	-	1.2	.0472	-	3.175	-	38	-	4.0
23005910	90816	23105910	90961	23105910B	90964	-	1.5	.0591	-	3.000	-	38	-	5.0
23005911	90819	23105911	90973	23105911B	90976	-	1.5	.0591	-	3.175	-	38	-	5.0
23006251	90822	23106251	90985	23106251B	90988	1/16	-	.0625	1/8	-	1-1/2	-	3/16	-
23006300	90825	23106300	90997	23106300B	91000	-	1.6	.0630	-	3.175	-	38	-	5.0
23007870	90828	23107870	91009	23107870B	91012	-	2.0	.0787	-	3.175	-	38	-	8.0
23009370	90831	23109370	91021	23109370B	91024	3/32	-	.0937	1/8	-	1-1/2	-	3/8	-
23009450	90834	23109450	91033	23109450B	91036	-	2.4	.0945	-	3.175	-	38	-	9.5
23011810	90837	23111810	91045	23111810B	91048	-	3.0	.1181	-	3.000	-	38	-	12.5
23011811	90840	23111811	91057	23111811B	91060	-	3.0	.1181	-	3.175	-	38	-	12.5
23012500	90843	23112500	91069	23112500B	91072	1/8	-	.1250	1/8	-	1-1/2	-	1/2	-

See full line catalog or visit www.maford.com for complete offering.



Series 231D / 231F



- Designed for routing of glass-reinforced printed circuit boards, phenolic-epoxy and other highly abrasive materials.
- Ultra fine micrograin carbide.
- Routers are available with color coded depth setting rings upon request.

Series 231D / 231F

MICRO Routers Diamond Grind Routers



Series 231D Down Cut
Drill Point



Series 231F Down Cut
Fishtail

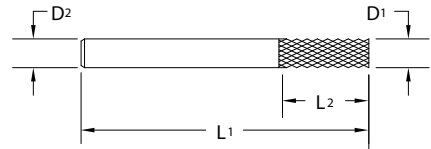

Series 231D		Series 231F		Diameter			Shank		OAL		Flute Length	
Tool No.	EDP	Tool No.	EDP	D1			D2		L1		L2	
				Inch	mm	Decimal	Inch	mm	Inch	mm	Inch	mm
23103120D	90907	23103120F	90910	1/32	-	.0312	1/8	-	1-1/2	-	1/8	-
23103150D	90919	23103150F	90922	-	0.8	.0315	-	3.175	-	38	-	3.0
23103940D	90931	23103940F	90934	-	1.0	.0394	-	3.175	-	38	-	4.0
23104690D	90943	23104690F	90946	3/64	-	.0469	1/8	-	1-1/2	-	5/32	-
23104720D	90955	23104720F	90958	-	1.2	.0472	-	3.175	-	38	-	4.0
23105910D	90967	23105910F	90970	-	1.5	.0591	-	3.000	-	38	-	5.0
23105911D	90979	23105911F	90982	-	1.5	.0591	-	3.175	-	38	-	5.0
23106251D	90991	23106251F	90994	1/16	-	.0625	1/8	-	1-1/2	-	3/16	-
23106300D	91003	23106300F	91006	-	1.6	.0630	-	3.175	-	38	-	5.0
23107870D	91015	23107870F	91018	-	2.0	.0787	-	3.175	-	38	-	8.0
23109370D	91027	23109370F	91030	3/32	-	.0937	1/8	-	1-1/2	-	3/8	-
23109450D	91039	23109450F	91042	-	2.4	.0945	-	3.175	-	38	-	9.5
23111810D	91051	23111810F	91054	-	3.0	.1181	-	3.000	-	38	-	12.5
23111811D	91063	23111811F	91066	-	3.0	.1181	-	3.175	-	38	-	12.5
23112500D	91075	23112500F	91078	1/8	-	.1250	1/8	-	1-1/2	-	1/2	-

See full line catalog or visit www.maford.com for complete offering.





Recommended Cutting Data Series 230 / 231/ 231B / 231D / 231F - Inch

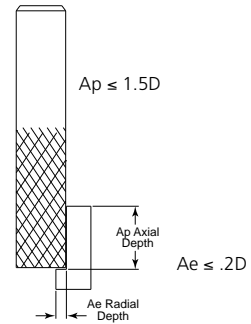
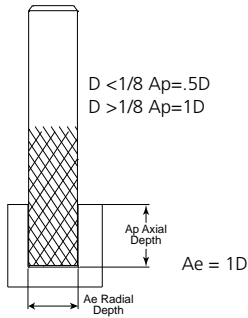

Slotting 300 (Sfm)		
Tool Diameter	RPM	IPM
1/32	36000	29
3/64	24000	24
1/16	18000	27
3/32	12000	24
1/8	9100	22

Slotting 600 (Sfm)		
Tool Diameter	RPM	IPM
1/32	73000	58
3/64	48000	48
1/16	36000	54
3/32	24000	48
1/8	18000	45

Side Milling 400 (Sfm)		
Tool Diameter	RPM	IPM
1/32	48000	39
3/64	32000	32
1/16	24000	36
3/32	16000	32
1/8	12000	30

Side Milling 900 (Sfm)		
Tool Diameter	RPM	IPM
1/32	90000	72
3/64	73000	73
1/16	55000	83
3/32	36000	72
1/8	27000	68

** Tool must have end grind in order to slot.

Note: The parameters in this table are for common material thickness of 1/4". You must use the Radial Depth (Ae) of 20% or less for Side Milling. For best surface finish conventional mill is recommended. Higher feed rates are possible but surface finish may change.

Technical data provided should be considered advisory only as variations may be necessary depending on the particular application.



Recommended Cutting Data Series 230 / 231/ 231B / 231D / 231F - Metric

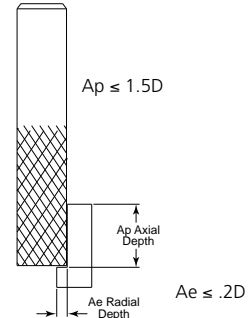
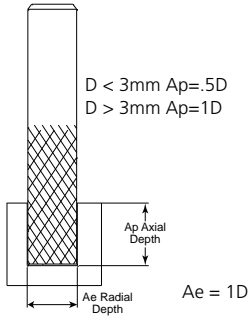

Slotting 90 (m/min)		
Tool Diameter	RPM	mm/min
0.8	35000	141
1	28000	226
1.2	23000	306
1.5	18000	376
1.6	17000	388
2	14000	423
2.4	11000	447
3	9400	480

Slotting 182 (m/min)		
Tool Diameter	RPM	mm/min
0.8	72000	289
1	57000	463
1.2	48000	627
1.5	38000	771
1.6	36000	795
2	28000	868
2.4	24000	916
3	19000	984

Side Milling 120(m/min)		
Tool Diameter	RPM	mm/min
0.8	47000	190
1	38000	305
1.2	31000	413
1.5	25000	508
1.6	23000	524
2	19000	572
2.4	15000	604
3	12000	648

Side Milling 240 (m/min)		
Tool Diameter	RPM	mm/min
0.8	95000	381
1	76000	610
1.2	63000	826
1.5	50000	1017
1.6	47000	1049
2	38000	1145
2.4	31000	1208
3	25000	1297

** Tool must have end grind in order to slot.

Note: The parameters in this table are for common material thickness of 6mm. You must use the Radial Depth (Ae) of 20% or less for Side Milling. For best surface finish conventional mill is recommended. Higher feed rates are possible but surface finish may change.

Technical data provided should be considered advisory only as variations may be necessary depending on the particular application.



 **M.A. FORD[®]**
High Performance Cutting Tools
ADVANCED PRODUCT GROUP



M.A. Ford[®] PCD
FIREARMS ARSENAL



CUSTOM Tool Division

Engineering & Manufacturing Excellence

The M.A. Ford® Custom Tool Division focuses on meeting the growing need for unique and increasingly complex special cutting tools. By partnering with select machine tool users the Custom Tool Division develops and supplies custom engineered carbide tools of unmatched quality which meet or exceed their productivity, delivery and utilized cost expectations. Custom tools are proven to increase speeds and feeds, save setup and handling time which in turn leads to faster run times, more efficient manufacturing and most importantly, INCREASED PROFITS.

To support your productivity improvement efforts, we offer the following services:

- Technical assistance in prototype custom tool design.
- Re-engineering of existing custom tooling to optimize tool performance.
- Tool manufacturing lead times which meet or exceed your delivery requirements.
- Immediate response to quotation request.
- Readily available technical phone support.
- Field representative support service.
- Emergency tool service.
- Custom tools of the highest quality.



Meeting the growing need for unique and increasingly complex high performance custom cutting tools in today's industry

Application Specific

Engineering the growing need for unique and increasingly complex high performance custom cutting tools in today's industry

M.A. Ford®'s Custom Tool Division can provide customized tooling solutions designed specifically to your application needs. M.A. Ford's Custom Tool Division can provide a tooling solution that will greatly reduce your machining costs, and improve your bottom line.

Quality

We offer application development, design and manufacturing expertise in the following product classifications: All tools in either Solid or Coolant Thru Configurations.

- High Performance Drills and Step Drills.
- Rockbit Drills (Flat Bottom - 150°).
- G-Drills and Step G-Drills.
- Step Reamers.
- Reamers.
- Coolant Thru Specials.
- Firearms Reamers (Chamber - Barrel - Muzzle - Throat).
- Custom End Mills.
- Custom Form Tools.
- Re-conditioning.
- Custom PCD tools.
- Brazed Carbide Tipped Specials.

Call us today to increase your productivity and profits with Custom Tooling

1-877-522-2885

e-mail: customtools@maford.com



QUALITY

Quality Certificate

intertek
Total Quality Assured.

CERTIFICATE OF REGISTRATION

This is to certify that the management system of:

M.A. Ford Mfg. Co., Inc.

Main Site: 7737 N.W. Boulevard
Davenport, Iowa 52808
United States

has been registered by intertek as conforming to the requirements of:

ISO 9001:2015

The management system is applicable to:

The design and manufacture of precision rotary cutting tools.

Certificate Number: 98-1247E
Initial Certification Date: 30 October 1998
Date of Certification Decision: 11 September 2018
Issuing Date: 11 September 2018
Valid Until: 10 September 2021

ANAB
ACCREDITED
MANAGEMENT SYSTEMS
CERTIFICATION BODY

Calin Moldovean
Calin Moldovean
President, Business Assurance

Intertek Testing Services NA, Inc.,
900 Chelmsford Street,
Lowell, MA 01851,
USA.



© 2018 Intertek. All rights reserved. Intertek assumes no liability to any person or entity for the design and manufacture of any product or service. The certificate is valid only if the organization maintains their system in accordance with the requirements of the certificate. Intertek may be contacted for more information. The certificate number is 98-1247E. The certificate number is 98-1247E. The certificate number is 98-1247E.



The M.A. Ford® Quality Policy is:

- Know our customers.
- Know their requirements.
- Make continual improvements in satisfying those requirements.

These are the responsibilities of every individual who works at M.A. Ford®.

Robert Hill, CEO





ALtima®

Aluminum Titanium Nitride (AlTiN). ALtima® is the original high performance coating. This coating allows tools to be run at higher speeds and feeds in a wide array of materials. Also, it allows the option of running tools dry due to the high oxidation temperature of the coating.

ALtima® Plus

This Aluminum Titanium Nitride (AlTiN) multi-layer coating has optimized coating structure, with pre and post treatment of the coating for optimized high performance drilling in any ferrous material.

ALtima® 52

Aluminum Titanium Nitride (AlTiN). ALtima® 52 is specially designed for milling hardened steels 52 Rc and above. It has very high hardness and the oxidation temperature of the coating makes this the absolute best choice for hardened steel milling. ALtima® 52 is designed to allow for dry machining.

ALtima® Blaze

Aluminum Chromium Nitride (AlCrN). ALtima® Blaze is designed to allow higher material removal rates. This coating has a higher oxidation temperature than a typical TiAlN coating. It has shown very good results in nickel alloys, titanium, and other difficult to machine materials. Tools coated with ALtima® Blaze can be used in dry machining.

ALtima® Micro

An ultra thin, nano structured, TiAlN coating developed specifically for micro tool applications.

ALtima® Xtreme

Designed for high speed and dry machining.

Fordlube

Titanium DiBoride (TiB₂) is a unique coating with low Aluminum affinity, smooth surface finish and high hardness. It is ideal for Aluminum and Magnesium alloys as it prevents build-up on cutting edge, provides superior chip flow along with extended wear resistance.

Gem+

Recommended for aluminium and aluminium alloys up to 12% Si, non-ferrous metals and composites. Gem+ provides excellent wear resistance and maintains sharp cutting edges.

GemX

A CVD diamond coating for composites and aluminum that offers the maximum hardness and wear resistance of any of our coatings.

TiN

Titanium Nitride (TiN). TiN coating has shown good results in low carbon steels and many iron-based applications. It is a very popular coating used in the industry today.

TiCN

Titanium Carbonitride (TiCN). TiCN is a multi-layer coating. Because of the multi-layer composition, TiCN is tougher than TiN, even though TiCN is harder. The added toughness of the TiCN coating makes it a good choice for mechanically stressed edges like in end mill applications. The higher hardness makes TiCN a good choice for abrasive applications where higher wear resistance is required.

CERAedge®

CERAedge® is a unique coating that provides excellent performance in titanium, aluminium, and composites.

Special Coatings

Upon request, M.A. Ford® can provide any commercially available coating. Any standard uncoated M.A. Ford® cutting tool can be provided with coating if requested.

Coating Properties

M.A. Ford® Coating	M.A. Ford® Tool Number Designation	Microhardness (HV)	Maximum Service Temp.	Friction Coefficient
ALtima®	A	3100	1100° C / 2012° F	0.42
ALtima® Plus	AP	3200	1100° C / 2012° F	0.25
ALtima® 52	A or AH	3600	1200° C / 2192° F	0.40
ALtima® Blaze	B	3200	1100° C / 2012° F	0.35
ALtima® Micro	AM	3300	900° C / 1652° F	0.30-0.35
ALtima® Xtreme	AX	3800	1100° C / 2012° F	0.30-0.50
Fordlube	F	4000	700° C / 1292° F	0.30
Gem+	GP	4710	500° C / 932° F	0.30
GemX	GX	10000	600° C / 1100° F	0.10
TiN	T	2300	600° C / 1112° F	0.40
TiCN	C	3000	400° C / 752° F	0.40
CERAedge®	CE	3400	1100° C / 2012° F	0.25



M.A. Ford® PCD



M.A. Ford® PCD, a part of M.A. Ford's Advanced Product Group, features a wide range of high performance, Polycrystalline Diamond (PCD) tipped tools to improve your productivity.

PCD tooling is ideal for more efficient machining of non-ferrous metals, plastics, composite materials, graphite and other hard to machine and abrasive materials.

M.A. Ford® PCD offers end mills and drills. Special tools are quoted upon request.

M.A. Ford® PCD is dedicated to continually developing innovative products manufactured with efficient state-of-the-art technology while offering great value and top quality at reasonable prices.

High Performance PCD Diamond Tools

- DES (M.A. Ford® PCD End Mill Square) Series - 1 & 2 Flutes, size range: 1/8" - 3/4", 3mm-20mm
- DES (M.A. Ford® PCD End Mill Square) Series - Multi-Flute, size range: 3/8" - 5/8", 8mm-16mm
- DEB (M.A. Ford® PCD End Mill Ball) Series, size range: 1/8" - 3/4", 3mm-20mm
- Custom Tool Division - Custom Tooling Solutions
 - DWD (M.A. Ford® PCD Cross Center Tip Drill) Series
 - PCD Specials • Drills & Step Drills • Reamers & Step Reamers
 - Form Tools • Step & Multi-step Tools • Re-conditioning & Re-tipping.



See full line catalog or visit www.maford.com for complete offering.



FIREARMS ARSENAL

The Custom Tool Division currently manufactures a variety of custom firearm solid carbide cutting tools. All of our firearms tools are custom made for the manufacturer's application. All tools are designed from customer prints or basic concepts provided from SAAMI specifications.









See full line catalog or visit www.maford.com for complete offering

Tapered Pin Reamers	Made to order sizing	
180 Slide Finishing End Mills	1/4" - 1"	6.0 - 20.0 mm
380 9 Flute Finishing End Mills	3/8" - 3/4"	8.0 - 20.0 mm
334 Magazine Rougher	1/4" - 1"	N/A
Rail Cutters	Made to order sizing	
Chamber Reamers	Made to order sizing	
Slot Cutters	Made to order sizing	
279 Ball Nosed End Mills	1/8" - 3/4"	3.0 - 16.0 mm

Firearms Arsenal











Material Conversion Chart

								
	USA	France	Brazil	German W-nr	German DIN	UK	Spain	Japan JIS
FREE MACHINING STEEL	12L13	S250Pb		1.0718	9SMnPb28		F.2112 -	
	1108	10F1		1.0721	10S20	210M15	F.2121 -	
	11L08	10PbF2		1.0722	10SPb20		F.2122 -	
				1.0723	15S20	210A15	F.210F -	
	1215	S300	1215	1.0736	9SMn36	240M07 EN 1B	F.2113 -	
	12L14	S300Pb		1.0737	9MnPb36		F.2114 -	
LOW CARBON STEEL	1010	AF34C10/XC10	1010	1.0301	C10	045M10		
	1015	AF37C12/XC18	1015	1.0401	C15	080M15;040A15	F.111	
	1020	AF42C20/XC25	1020	1.0402	C22	055M15 EN2C	F.112	
	1025	AF50C30		1.0406	C25	070M26	F.221	
	1212			1.0711	9S20	220M07		
	1213	S250	1213	1.0715	9SMn28	230M07	F.2111 -	
	1010	XC10	1010	1.1121	Ck10	040A10	F.1510 -	
	1022/1518	20M5		1.1133	20Mn5	120M19	F.1515 -	
	1015	XC15 / C15E	1015	1.1141	Ck15	080M15 EN 32C	F.1511 -	
	1020/1023	XC25 / C22E	1020	1.1151	Ck22	050A20	F.1120 -	
	1025	XC25 / C25E		1.1158	Ck25	070M26	F.1120 -	
	A350-LF5	15Ni6 / 15Ni6		1.5622	14Ni6		F.2641 -	
	3310/9314	12NC15		1.5752	14NiCr14	655M13/A12 EN 36A		
	MEDIUM CARBON STEEL	1035	AF55C35 /XC38	1035	1.0501	C35	060A35	F.113
1045		AF65C45 /C45	1045	1.0503	C45	080M46	F.114	
1040		AF60C40 C40		1.0511	C40		F.114.A	
1055		C55	1055	1.0535	C55	070M55		
1060		AF70C55 / C60	1060	1.0601	C60	080A62 EN 43D	F.115	
1140		35MF6	1140	1.0726	35S20	212M36 EN 8M	F.210G.	
1146		45MF4		1.0727	45S20	212M44		
9255		51S7		1.0903	51S17	250A53 EN 45	F.1450 -	
9255		55S7	9254	1.0904	55S17		F.1440 -	
9260		60S7		1.0909	60S17	250A58	F.1441 -	
9262		60SC7		1.0961	60SiCr7	250A61	F.1442 -	
1330/1536		35M5 / 30Mn5		1.1165/66	30Mn5/34Mn5	120M36/150M28	F.1203	
1335		40M5 / 36Mn5	1541	1.1167	36Mn5	150M36 EN 15	F.1203 -	
1330		20M5 / 28Mn6	1330	1.117	28Mn6	150M28 EN 14A		
1035		XC32 / C35R	1035	1.118	Cm35	080M36	F.1135 -	
1040		XC42H1 / C40E	1040	1.1186	Ck40	060A40/080A40		S 40 C
1045		XC42H1 / C45/XC45	1045	1.1191	Ck45	080M46/060A47	F.1140 -	S 45 C
1045		XC42H1 /C45R	1045	1.1201	Cm45	080M46	F.1145 -	
1055		XC55H1 / C55E	1055	1.1203	Ck55	060A57/070M55	F.1150 -	S55C
1050	XC48H1 / C50E	1050	1.1206	Ck50	080M50			
1050	XC48H1TS	1050	1.1213	Cf53	060A52			
1060	XC60 / C60E/2C60	1060	1.1221	Ck60	060A62	F.511/F.512	S58C	
1070	XC68	1070	1.1231	Ck67	060A67			
ALLOY STEEL	1080/1078/1086	XC75 / C75E/XC90	1074	1.1248/1269	Ck75	060A78	F.513/514/515	
	1095	XC100	1095	1.1274	Ck101	060A96		
	4135/4142	34CD4 /42CD4		1.233	35CrMo4/47CrMo4	708A37/M40		SCM435TK
	3135/3140	35NC6		1.571/1.5711	36NiCr6/40NiCr6	640A35/M40 EN111A		
	8620/8720	20NCD2	8620	1.6523/43	21NiCrMo2	805M20/A20 EN 362	F.1522 -	SNCM220(H)
	8740	40NCD2	8640	1.6546	40NiCrMo22	311-Type7	F.1204 -	SNCM240
		18NCD6		1.6587	17CrNiMo8	820A16	F.1560 -	
	5132	32C4 / 34Cr4		1.7033	34Cr4	530A32 EN18B	F.8221 /F.224	SCR430(H)
	5135	38C4 / 37Cr4	5135	1.7034	37Cr4	530A36	F.1201 -	
	5140	42C4 / 41Cr4	5140	1.7035	41Cr4	530M40/A40 EN 18	F.1202 -	SCR440(H)
	5140	42C4TS	5140	1.7045	42Cr4	530A40	F.1202 -	SCR440
	5115	16MC5	5115	1.7131	16MnCr5	527M17	F.1515 -	
	5155	55C3		1.7176	55Cr3	527A60 EN 48	F.1431 -	SUP9(A)
	4130	25CD4 / 25CrMo4	4130	1.7218	25CrMo4	1717CDS110	F.8330 -	SCM420/430
4135/4137	35CD4 / 34CrMo4		1.722	34CrMo4	708A37 EN 19B	F.8231 -		
4140/4142	42CD4 / 42CrMo4	4140	1.7225	42CrMo4	708M40 EN 19A	F.8232 -		
4150	50CrMo4	4150	1.7228	50CrMo4	708A47			
6150	50CV4 / 51CrV4	6151	1.8159	50CrV4	735A50 EN 47	F.1430 -		









Technical data provided should be considered advisory only as variations may be necessary depending on the particular application.

Material Conversion Chart

								
	USA	France	Brazil	German W-nr	German DIN	UK	Spain	Japan JIS
HIGH STRENGTH ALLOY STEEL	A355Cl.D	30CAD6.12		1.8507	34CrAlMo5	905M31	F.1741 -	
	A355Cl.A	40CAD6.12		1.8509	41CrAlMo7	905M39 EN 41B	F.1740 -	
		18NC13		1.5755	31NiCr14	653M31	F.123	
	9840	40NCD3		1.6511	36CrNiMo4	816M40 EN 110	F.1280	
	4340		4340	1.6562	40NiCrMo73	817M40		SNCM 447
		30CND8		1.658	30CrNiMo8	823M30		
	4340	35NCD6	4340	1.6582	34CrNiMo8	817M40 EN 24	F.1272	SNCM 447
		35NCD14		1.6746	32NiCrMo145	830M31	F.1262	
	35NCD16		1.6747	30NiCrMo166	835M30	F.1260		
	30CD12		1.8515	31CrMoV139	722M24 EN 40B	F.1712		
			1.8523	39CrMoV139	897M39 EN 40C			
STRUCTURAL STEEL	A570 (36)	E24-2NE / S235JRG2	A36	1.0038	St37-2	4360-40C		STKM 12A
	A570 (40)	E28-2 / S275JR		1.0044	St44-2	4360-43A/B	A 430B	SM 400 A;B;C
	A570 (50)	A50-2 / E295		1.005	St50-2	4360-50B		SS490
		A60-2 / E335-A70-2/E360		1.006/007	St60-2/St70-2	4360-55E		
	A284/A573/A611	E24-3;-4 / S235J2G3		1.0116	St37-3	4360-40C/D-1449-37C	A360 C,D	
	A366/1012/A619	DC01		1.033/0333	St12/13	1449 -2/3/4CR	AP 00/02	
	A620	DC04		1.0338	St14	1449 1CR; 2CR	AP 04	
	A516Gr.65;55;	A37CP;AP / P235GH		1.0345	H I	1501Gr.161-360/400	A 37 RC I;RA II	
		A42CP;AP / P265GH		1.0425	H II	161-400;	A42 RC I	
	A537	A52CP;AP / P335GH		1.0473	19Mn6		A 47 RB II	
	A516 (70)	A48CP;AP / P295GH		1.0481	17Mn4		A 47 RC I; RA II	
		E36-3/4 / S355J2G3		1.057	St52-3	4360-50B;50C;50D	A 510 C;D	
	A204 (A)	15D3 / 15Mo3		1.5415	15Mo3	1501-240	F.2601 -	
	4520			1.5423	16Mo5	1503-245-420	F.2602 -	
	A350-LF3	12Ni14 / 12Ni14		1.5637	10Ni14	1501-503-690	F.152	
	3115	10NC6		1.5713	13NiCr6			
	3415	14NC11		1.5732	14NiCr10		F.1540	
	A182-F11;F12	15CD3.05		1.7335	13CrMo44	620Gr.27;31	F.2631	
	A387 (12)	15CD4.5		1.7337	16CrMo44	620Gr.27		
	A182F22	10CrMo9-10		1.738	10CrMo910	622Gr.31;45	TU.H	
A633Gr.E	E420RIFP / S420N		1.8902	StE420	4360-55E	AE 420 KG		
A633Gr.E	E460RIFP / S460N		1.8905	StE460		AE 460 KG		
HIGH TEMPERATURE ALLOYS	330	Z12NCS37.18		1.4864	X12NiCrSi3616	NA17	F.3313	
				1.4865	G-X40NiCrSi3818	330C40		
	B163	Z8NC3221		1.4876	X10NiCrAlTi3320	NA15(H)	F.3545	
	4544/SB127/164	NU30		2.436	NiCu30Fe	3072-76/NA13		
	4676			2.4375	NiCu30Al	3072-76/NA18/3146		
	5388 C	NC 17 DWY		2.4602	NiCr17Mo17FeW			
		NC 20 T		2.463	Ni-Cr20Ti	HR5/203-4/703-B		
		NC 20 TA		2.4631	NiCr20TiAl	HR 401HR601/736B		
		NCKD 20 ATV		2.4634	NiCo20Cr15MoAlTi	HR 3/5007		
	687	NCKD 20 AT		2.4636	NiCo15Cr15MoAlTi			
		NCK 20 D		2.465	NiCr20Co19MoTi	HR 10		
	5660C	Z8 NCDT 42		2.4662	NiCr15MoTi			
	5536E	Nc 22 FeD		2.4665	NiCr22Fe18Mo	HR 6/204		
		NC 19 FeNb		2.4668	NiCr19Fe19NbMo	HR 8		
	5542G	NC 15 Fe TNb		2.4669	NiCr16FeTi	HR 505		
	5391A	NC 13 AD		2.467	G-NiCr13Al6MoNb	HC 203		
		NK 15 CAT		2.4674	NiCo15Cr10MoAlTi	HC 204		
	5540	NC 15 Fe		2.4816	NiCr15Fe	3072-76		
	5581	NC 22 FeDNB		2.4856	NiCr22Mo9Nb			
		NC 21 FeDU		2.4858	NiCr21Mo	3072-76		
	NC 19 KDT		2.4973	NiCr19Co11MoTi				
684	NCK 19 DAT		2.4983	NiCr18Co18MoAlTi				
TITANIUM ALLOYS		T-35		3.7024/25	Ti 99,8	TA.1	Ti-P01	
		T-U2		3.7124	TiCu2	TA.21-24/52-55/58	Ti-P11	
		T-A6ZD		3.7154	TiAl6Zr5Mo,5Si0,2	TA.43/44	Ti-P67	
		T-A4DE		3.7184	TiAl4Mo4Sn2Si0,5	TA.45-51/57	Ti-P68	
	4941/42/51/4902	T-40		3.7034/35	Ti 99,7	TA.2/3/4/5	Ti-P02	
	4901/21	T-60		3.7064/65	Ti99,5	TA.6/7/8/9	Ti-P04	
	491128/35/54/65/67	T-A6V		3.7164/65	TiAl6V4	TA.10-13/28/56	Ti-P63	
	4900	T-50				DTD 5023/5283		









Technical data provided should be considered advisory only as variations may be necessary depending on the particular application.

Material Conversion Chart

								
	USA	France	Brazil	German W-nr	German DIN	UK	Spain	Japan JIS
STAINLESS STEELS	410S	Z3014		1.4001	X7Cr14	403S17	F.8401	
	405	Z6CA13 / Z6CrAl13		1.4002	X6CrAl13	405S17	F.3111	
	416	Z12CF13 / Z12CrS13		1.4005	X12CrS13	416S21	F.3411	SUS 416
	410/CA-15	Z12C13 / Z12Cr13	410	1.4006	X10Cr13	410S21 ENEN 56A	F.3401	SUS 410
	430	Z8C17 / Z6Cr17		1.4016	X6Cr17	430S15 EN 60	F.3113	SUS 430
	420	Z20C13 / Z20Cr13	420	1.4021	X20Cr13	420S37	F.3402	SUS 420
		Z40C14 / Z40Cr14		1.4034	X46Cr13	420S45 EN 56D	F.3405	
	431	Z15CN16.02		1.4057	X20CrNi172	431S29 EN 57	F.3427	
	430F	Z10CF17		1.4104	X12CrMoS17		F.3117	
	434	Z8CD17.01		1.4113	X6CrMo17	434S17		
	440C	Z100CD17		1.4125	X105CrMo17			
	304/304H	Z6CN18.09	304	1.4301	X5CrNi1810	304S15 EN 58E	F.3451	SUS304
	308; 305	Z8CN18.12		1.4303	X5CrNi1812	305S19	F.3513	
	303	Z10CNF18.09	303	1.4305	X10CrNiS189	303S21 EN 58M	F.3508	SUS303
	304L	Z2CN18.10/Z3CN19.10M		1.4306	G-X2CrNi189/1911	304S12/S11/C12	F.3503	SCS19
	CF-8	Z6CN18.10M		1.4308	G-X6CrNi189	304C15		
	301	Z12CN17.07	302	1.431	X12CrNi177	301S21	F.3517	
	304LN	Z2CN18.10Az		1.4311	X2CrNiN1810	304S62		
		Z10CN18.9M		1.4312	G-X10CrNi188	302C25		
	CA6-NM	Z4CND13.4M		1.4313	G-X5CrNi134	425C11		
	316/316L	Z6CND17.11	316	1.4401	X5CrNiMo17122	316S16/S31 EN 58J	F.3543	SUS316
	316L	Z2CND 18.13	316L	1.4404	X2CrNiMo17132	316S11/S12	F.3533	SUS316 L
	316LN	Z2CND 17.12Az		1.4406	ZCrNiMoN17122	316S61		SUS316LN
	CF-8M			1.4408	G-X6CrNiMo1810	316C16	F.8414	
	316LN	Z2CND17.13Az		1.4429	X2CrNiMo17133	316S62		SUS316LN
	316L	Z2CND17.13		1.4435	X2CrNiMo18143	316S11/S12	F.3533	SUS316LN
	316	Z6CND17.12		1.4436	X5CrNiMo17133	316S16	F.3534	SUS316
	317L	Z2CND19.15		1.4438	X2CrNiMo18164	317S12		SUS317L
	329		329 (DUPLEX)	1.446	X8CrNiMo275		F.3309	SUS329
	XM8/430Ti	Z8CT17		1.451	X6CrTi17		F.3114	
	409	Z6CT12		1.4512	X5CrTi12	409S19		
	321	Z6CNT18.10	321	1.4541	X6CrNiTi1810	321S12/S31 EN 58B	F.3523	SUS321
	630	Z6CNU17.04		1.4542	X5CrNiCuNb1714			SUS630
	347	Z6CNNb18.10		1.455	X6CrNiNb1810	347S17/S31 EN 58F	F.3552	SUS347
	316Ti	Z6CNDT17.12		1.4571	X6CrNiMoTi17122	320S31/S17 EN 58J	F.3552	
	316Ti			1.4573	X10CrNiMoTi1812	320S33		
	316Cb	Z6CNDNb17.12/19.13		1.458	X6CrNiMoNb17122	318S17		
	HNV3	Z45CS9		1.4718	X45CrSi93	401S45 EN52	F.3220	
		Z10C13		1.4724	X10CrAl13	403S17	F.13152	
		Z40CSD10		1.4731	X40CrSiMo102		F.3221	
	430	Z10CAS18		1.4742	X10CrAl18	430S15	F.3153	SUS430
	HNV6	Z80CSN20.02		1.4747	X80CrNiSi20	443S65 EN 59	F.3222	
	446	Z10CAS24		1.4762	X10CrAl24		F.3154	SUH446
	309	Z15CNS20.12		1.4828	X15CrNiSi2012	309S24		
	309S	Z15CN24.13		1.4833	X7CrNi2314	309S24		
	314/310	Z15CNS25.20	314	1.4841	X15CrNiSi2520		F.3310	
	310S	Z12CN25.20	310	1.4845	X12CrNi2521	310S24	F.331	
	HK			1.4848	G-X40CrNiSi2520	310C40	F.8452	
	EV8	Z52CMN21.09		1.4871	X53CrMnNiN219	349S54	F.3217	
		Z35CNWS14.14		1.4873	X45CrNiW189	331S40	F.3211	
321	T6CNT18.12(B)		1.4878	X12CrNiTi189	321S20	F.3523	SUS321	
A353	Z8N9		1.5662	X8Ni9	1501-509;510	F.2645		
2515	Z18N5		1.568	12Ni19				









Technical data provided should be considered advisory only as variations may be necessary depending on the particular application.

Material Conversion Chart

									
	USA	France	Brazil	German W-nr	German DIN	UK	Spain	Japan JIS	
TOOL STEELS	A532IBNiCr-LC			0.962	G-X260NiCr42	Grade2A			
	A532IANiCr-HC			0.9625	G-X330NiCr42	Grade2B			
	A532IDNi-HiCr			0.963	G-X300CrNiSi952	Grade2C,D,E			
	A532IID20%CrMo-LC			0.9645	G-X260CrMoNi2021	Grade3C			
	A532IIIA25%Cr			0.965	G-X260Cr27	Grade3D			
	A532IIIA25%Cr			0.9655	G-X300CrMo271	Grade3E			
	W108	Y190;Y180		1.1525	C80W1				
	W110	Y1105		1.1545	C105W1				SK3
	W112	Y2120		1.1663	C125W		F.5123		
	W1			1.175/.1625	C75W/C80W1	BW1A/BW1B	F.1507		
	L3	Y100C6	52100	1.2067	100Cr6	BL3	F.5230		
	D3	Z200C12	420 (1.2083)	1.208	X210Cr12	BD3	F.5212		
	L2			1.221	115CrV3				
	H11	Z38CDV5	H11	1.2343	X38CrMoV51	BH11	F.5317		
	H13	Z40CDV5	H13	1.2344	X40CrMoV51	BH13	F.5318		SKD61
	A2	Z100CDV5	A2	1.2363	X100CrMoV51	BA2	F.5227		SKD12
	H10	32DCV28	H10	1.2365	X32CrMoV33	BH10	F.5313		
	D2	Z160CDV12	D2	1.2379	X155CrVMo121	BD2			
		105WC13		1.2419	105WCr6		F.5233		
			D6 (VC131)	1.2436	X210CrW12		F.5213		
	O1		O1 (VND)	1.251	100MnCrW4	BO1	F.5220		SKS 31
	S1		S1 (VW3)	1.2542	45WCrV7	BS1	F.5241		
		55WC20		1.255	60WCrV7				
	H21	Z30WCV9	H20/H21	1.2581	X30WCrV93	BH21	F.5323		SKD5
				1.2601	X165CrMoV12		F.5211		
	H12	Z35CWDV5	H12	1.2606	X37CrMoW51	BH12			
	L6	55NCDV7	(VMO)	1.2713	55NiCrMoV6		F.528		
	W210	Y1105V		1.2833	100V1	BW2			
	2	90MV8		1.2842	90MnCrV8	BO2			
	T15			1.3202	S12-1-4-5	BT15	F.5563		
		Z130WKCDV10-10-04-03		1.3207	S10-4-3-10		F.553		
		Z85WDCV06-05-05-04-02	M35	1.3243	S6-5-2-5		F.5613		
	M41	Z110WKCDV07-05-04-04-02		1.3246	S7-4-2-5		F.5613		
	M42	Z110DKCWV09-08-04-02-01	M42	1.3247	S2-10-1-8	BT42	F.5615		
	M33/M34			1.3249	S2-9-2-8	BM34	F.5611		
	T4	Z80WKC18-05-04-01		1.3255	S18-1-2-5	BT4	F.5530		
	T5			1.3265	S18-1-2-10	BT5	F.5540		
	M3	Z90WDCV06-05-04-03		1.3342	SC6-5-2				
	M2	Z85WDCV06-05-04-02	M2	1.3343	S6-5-2	BM2	F.5603		
	M3class2	Z130WDCV06-05-04-04	M3:2	1.3344	S6-5-3		F.5605		
H41/M1	Z85DCWV08-04-02-01		1.3346	S2-9-1	BM1				
M7	Z100DCWV09-04-02-02	M7	1.3348	S2-9-2		F.5607			
T1	Z80WCV18-04-01		1.3355	S18-0-1	BT1	F.5520			
A128(A)	Z120M12 / Z120Mn12		1.3401	X120Mn12		F.82551			
52100	100C6	52100	1.3505	100Cr6	534A99	F.1310			
HARDENED STEEL									
CAST ALUMINIUM	319,2	A-55U		3.2151	G-ALSi6Cu4	LM4/LM22	L-2660		
	380,1	A-59U3		3.2161	G-ALSi8Cu3	LM24	L-2630		
		A-54G		3.2341	G-ALSi5Mg	DTD716B			
	A356.2	A-57G0,3		3.2371	G-ALSi7Mg	2L99/LM25			
		A7-S10G		3.2373	G-ALSi9Mg				
	A360	A-S10G		3.2381	G-ALSi10Mg	LM9	L-2560		
	413,1	A-S12U		3.2583	G-ALSi12Cu	LM20	L-2530		
	514.1	A-G6		3.3561	G-ALMg5	LM5			
	A413	A-S13		3.3581	G-ALSi12	LM6	L-2520		
	520	A-G10-Y4		3.3591	G-ALMg10	LM10	L-2310		
	390				ALSi17Cu4				
	393				ALSi18-25CuNiMg	LM28/LM29			

Technical data provided should be considered advisory only as variations may be necessary depending on the particular application.

Material Conversion Chart

								
	USA	France	Brazil	German W-nr	German DIN	UK	Spain	Japan JIS
WROUGHT ALUMINIUM	1200	A4		3.0205	Al99	1C	L-3001	
	1050A	A5		3.0255	Al99,5	1B	L-3051	
	1350A	A5/L		3.0257	E-Al	1E	L-3052	
	1080A	A8		3.0285	Al99,8	1A	L-3081	
	1199	A99		3.0385	Al99,98R	1		
	3004	A-M1G		3.0526	AlMnMg1	N4	L-3820	
	2014	A-U4SG		3.1255	AlCuSiMn	H15	L-3130	
	2117	A-U2G		3.1305	AlCu2,5Mg0,5	3L86/HR13	L-3180	
	2017A	A-U4G		3.1325	AlCuMg1	H14	L-3120	
	2024	A-U4G1		3.1355	AlCuMg2	2L98	L3140	
	2003	A-U4Pb		3.1645	AlCuMgPb		L-3121	
	2011	A-U5PbBi		3.1655	AlCuBiPb	FC1	L-3182	
	6101B			3.2305	E-ALMgSi	91E	L-3431	
	6463	A85-G5		3.2307	Al99,85MgSi	BTR6		
	6181	A-5GM0,7		3.2315	Al-Si1 Mg	H30	L-3451	
	6060			3.3206	AlMgSi0,5	H9	L-3441	
	6101C	A-G5/L		3.3207	E-ALMgSi0,5	BTR6		
	5005A	A-G0,6		3.3315	AlMg1	N41	L-3350	
	5050B	A-G1,5		3.3316	AlMg1,5	3L44	L-3380	
	5052	A-G2,5C		3.3523	AlMg2,5	N5Mg3,5	L-3360	
	5251	A-G2M		3.3525	AlMg2Mn0,3	N4		
	5754	A-G3M		3.3535	AlMg3		L-3390	
	5454	A-G2,5MC		3.3537	AlMg2,7Mn	N51		
	5083	5083		3.3547	AlMg4,5Mn	N8	L-3321	
	5056A			3.3555	AlMg5	N6	L-3320	
7020	A-Z5G		3.4335	AlZn4,5Mg1	H17	L-3741		
7075	A-Z5GU		3.4365	AlZnMgCu1,5	2L95	L-3710		
SG / NODULAR CAST IRON	60-40-18	FGS 400-12		0.704	GGG-40	420/12		
		FGS370-17		0.7043	GGG-40,3	370/17		
	65-45-12	FGS500-7		0.705	GGG-50	500/7		FDC500
	80-55-06	FGS 600-3		0.706	GGG-60	600/3		
	100-70-03	FGS 700-2		0.707	GGG-70	700/2		FDC700
	120-90-02	FGS 800-2		0.708	GGG-80	800/2		
		MB 35-7		0.8035	GTW-35-04	W 340/3		
		MB 40-10		0.804	GTW-40-05	W 410/4		
				0.8045	GTW-45-07			
	32 510	MN 35-10		0.8135	GTS-35-10	B 340/12		
		MP 50-5		0.8145	GTS-45-06	P 440/7		
		MP 60-3		0.8155	GTS-55-04	P 540/5		
			0.8165	GTS 65-02				
70 003	MP 70-2		0.817	GTS 70-02	P 690/2			
GREY / WHITE CAST IRON	A48-40B	Ft25D / FGL250		0.6025	GG25	Grade 260	FG 25	
	A48-20B	Ft10D / FGL100		0.601	GG10		FG 10	
	A48-25B	Ft15D / FGL150		0.6015	GG15	Grade 150	FG 15	
	A48-30B	Ft20D / FGL200		0.602	GG20	Grade 220	FG20	
	A48-45B	Ft30D / FGL300		0.603	GG30	Grade 300	FG 30	
	A48-50B	Ft35D / FGL350		0.6035	GG35	Grade 350	FG35	
A48-60B	Ft40D / FGL400		0.604	GG40	Grade 400			
BRONZE ALUMINUM BRONZE TIN BRONZE	C 60 800	CuAl6		2.0918	CuAl5As			
	C 61 000	CuAl8		2.092	CuAl8			
	C 61 400	CuAl7Fe2		2.0932	CuAl8Fe3	CA 106		
	C 62 300	CuAl9Fe3Mn2		2.0936	CuAl10Fe3Mn2	CA 105		
	C 95 200	CuAl9Fe3		2.094	CuAl10Fe	AB 1		
	B 505	CuAl9Fe3		2.094	G-FeAlBzF50	AB 1		
		CuAl9Mn2		2.096	CuAl9Mn2			
	C 63 200	CuAl9Ni5Fe3Mn		2.0966	CuAl10Ni5Fe4	CA 104		
	C 95 800	CuAl9Ni5Fe		2.097	G-NiAlBzF50	AB 2		
		CuAl11Ni5Fe5		2.0978	CuAl11Ni6Fe5			
C 94100	CuPb20Sn5		2.1188	G-CuPb20Sn	LB5			

Technical data provided should be considered advisory only as variations may be necessary depending on the particular application.

Material Conversion Chart

								
	USA	France	Brazil	German W-nr	German DIN	UK	Spain	Japan JIS
BRASS	C 21000/34500	CuZn5		2.022/2.032	CuZn5	CZ 125/101		
	C 85700	CuZn40-Y30		2.034	G-CuZn37Pb	PCB 3		
	C 28000/38500	CuZn40/44Pb2		2.036/2.041	CuZn40/44Pb2	CZ 109/CZ130		
	C 68700	CuZn22Al2		2.046	CuZn20Al2	CZ 110		
	C 44300			2.047	CuZn28Sn1	CZ 111		
	C 46400			2.053	CuZn38Sn1	CZ 112		
	C 67400			2.055	CuZn40Al2	CZ 114		
	C 86400			2.0591	G-CuZn38Al	PCB1, DCB 3		
	C 86400	CuZn40-Y30		2.0592	G-CuZn35Al1	HTB 1		
	C 86300			2.0598	G-CuZn25Al5	HTB 3		
	C 90500			2.105	G-CuSn10Zn	G1		
	C 90800	CuSn12		2.1052	G-CuSn12	Pb2		
	C 91700			2.106	G-CuSn12Ni	CT2		
	C 90250			2.1086	G-CuSn10	CT1		
	C 93200	CuSn7Pb6Zn4		2.109	G-CuSn7ZnPb			
	C 92410			2.1093	G-CuSn6ZnNi	LG4		
	C 83600	CuPb5Sn5Zn5		2.1096	G-CuSn5ZnPb/RG5	LG2		
C 93700	CuPb10Sn10		2.1176	G-CuPb10Sn	LB2			
C 93800			2.1182	G-CuPb15Sn	LB1			
COPPER COPPER-NICKEL ALLOYS	C 96200			2.0815	G-CuNi10			
	C 71300	CiNi25		2.083	CuNi25	CN 105		
	C 96400			2.0835	G-CuNi30	CN 2		
	C 72150	CuNi44		2.0842	CuNi44Mn1			
	C 70600	CuNi10Fe1Mn		2.0872	CuNi10Fe1Mn	CN 102		
	C 71500	CuNi30Mn1Fe		2.0882	CuNi30Mn1Fe	CN 107		
	C 17000	CuBe1,7		2.1245	CuBe1,7	CB 101		
	C 17200	CuBe1,9		2.1247	CuBe2			
	C 17500			2.1285	CuCo2Be	C 112		
	C 71640	CuNi30Fe2Mn2			CuNi30Fe2Mn2	CN 108		
	OF	Cu-c1/C2		2.004	OF-Cu	Cu-OF C 103/110		
	C 11000	Cu-a1/A2		2.006	E-Cu57	Cu-ETP-2 C 101		
	C 11000	Cu-a1		2.0065	E-Cu58	Cu-ETP-2 C 101		
	C 1200	Cu-b2		2.0076	SW-Cu			
	C 12200	Cu-b1		2.009	SF-Cu	Cu-DHP C 106		

Technical data provided should be considered advisory only as variations may be necessary depending on the particular application.



Where **high performance** is the **standard***

Also available:



M.A. Ford® Europe Ltd.

650 City Gate
London Road, Derby
DE24 8WY
United Kingdom

Tel: +44 (0) 1332 267960
Fax: +44 (0) 1332 267969
e-mail: sales@mafordeurope.com
www.mafordeurope.com

**M.A. Ford® Mfg. Co., Inc.
7737 Northwest Blvd.**

Davenport, IA 52806
USA

Tel: 563-391-6220 or 800-553-8024
e-mail: sales@maford.com
www.maford.com

M.A. Ford® Asia-Pacific Limited

Room 1709, Level 17
Millennium City 2
378 Kwun Tong Road
Kowloon, Hong Kong

Tel: +852-2167-7150
Fax: +852-2167-8150
e-mail: sales@mafordeurope.com